

djv[®] BY **DJPOWER**[®]

[PRO STAGE EFFECTS]

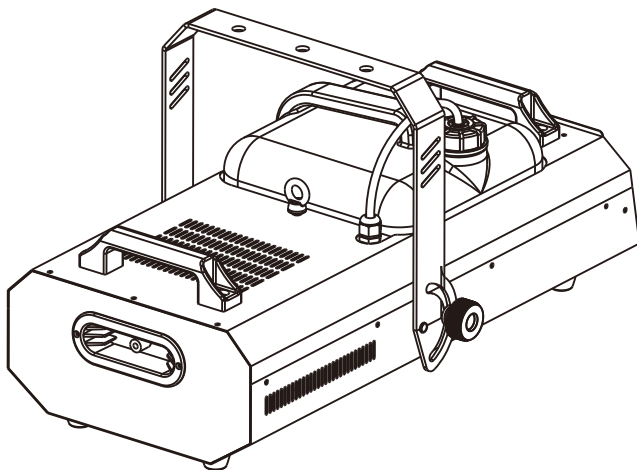

DF-3000S *USER MANUAL*

FOG MACHINE

GUANGZHOU DJPOWER ELECTRONIC TECHNOLOGY CO.,LTD

◆ Foreword

Thank you very much of choosing DJPOWER DF-3000S fog machine. Before start operating, we strongly suggest you to read the user manual carefully. Following the instructions here will ensure your safety while operating the machine, easily achieve the best effect, as well as understand the right way to care for and maintain the machine, hence to prolong the product life cycle.

◆ Safety use

- Keep the fixture dry. For indoor and outdoor used.
- Use grounded electrical outlet. Prior to use, make sure that unit is installed at the rated voltage.
- Turn off or unplug when not using it.
- This machine is not water-proof. Please keep it away from moisture and water. If moisture, water, or fluid gets inside the housing, stop using it.
- No user serviceable and modifiable parts inside. Do not disassemble the housing and do any modification, otherwise it might cause damage to the unit or danger of burning.
- For adult use only. Fixture must be installed out of the reach of children. Never leave the unit running unattended. Keep it away from fire, combustible and flammable materials.
- Position the machine in well-ventilated area. Please leave about 50cm spaces surrounding the unit.
- Please do not use the fixture under high temperature.
- Never add flammable liquids of any kind (oil, gas, perfume) to the fog liquid.
- If something wrong happens while using, please stop the fixture immediately, cut off the power, and check the fog liquid amount, fuse, power cable and power plug. If problem could not be resolved, please contact with your dealer.
- Use only DJPOWER high-quality DJ fog liquid.
- Never drink liquid. If it is ingested, call a doctor immediately for any discomfort. If liquid comes in contact with skin or eyes, rinse thoroughly with water.

◆ The following parts should be included when you receive the packages of DF-3000S:

1. One DF-3000S fog machine.
2. A set of W-2 controller, including a transmitter and a remote.
3. One power cord.
4. One user manual.

◆ Operating instruction

1. After checking that all the parts are intact and complete, position the machine on flat. Pour DJ fog liquid into the oil tank carefully and screw the cap.

2. Connecting the power cord. Before power on, make sure it is connected with the rated voltage.
3. Turn on the machine, it will immediately start heating up, the LCD display will show "WARMING UP".
4. It takes about 5 minutes for DF-3000S's to heat up completely. The LCD display will change to "READY TO FOG" when it is ready. After the first time's work, it will take another 1 minute to reheat up.

◆ **Function**

DF-3000S is equipped with W-2 wireless controller. Under wireless remote mode, it will work at largest output. The fog output volume can be set by the LCD display, also by DMX. This machine can keep making fog for at least 20s continuously.

◆ **Operating control panel**

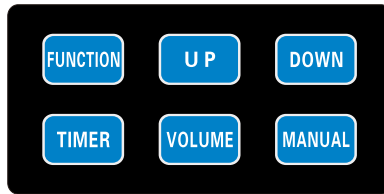

1. When the LCD displays "READY TO FOG", push the **FUNCTION** button once, the LCD will display [INTERVAL SET](this is to set the time interval between each emission). During this mode, user can set up the time interval of the fog output by pushing buttons **UP** and **DOWN** (the time interval can be set from 1 to 200 seconds)
2. When the LCD displays "READY TO FOG", push the **FUNCTION** button twice, the LCD will display [DURATION SET](this is to set the continuous fog time). During this mode, user can set up the continuous fog time by pushing **UP** and **DOWN** .(the range of the output time can be set from 1 to 200 seconds)
3. When the LCD displays "READY TO FOG", push the **FUNCTION** button three times, the LCD will display [TIMER OUT](this is to set the fog output amount). Under this mode, user can set up the timer by pushing **UP** and **DOWN** to adjust the fog output volume.(the range of the output can be set between 1% to 100%)

When the LCD displays "READY TO FOG", push the **TIMER** button will enable the user to initiate preset up preferred timer mode. Machine will work according to the set up interval time, and amount to create the most satisfactory fog. While the machine is under the operating mode, push **TIMER** button one more time will exit the timer mode.

4. When the LCD displays "READY TO FOG", push the **FUNCTION** button four times, the LCD will display [VOLUME OUT]. Under this mode, user can use the **UP** and **DOWN** to adjust the output volume.(range from 1% to 100%).

When the LCD displays “READY TO FOG” , push the **VOLUME** button will enable the initiate output mode. While the machine is still in operation, push **VOLUME** button one more time will exit the direct fog mode.

- When the LCD displays “READY TO FOG” , push the **FUNCTION** button six times, the LCD screen will display [DMX 512]. Under this mode, user can use the button **UP** and **DOWN** to set the DMX address.

The DF-3000S fog machine has one DMX channel. Value 0-5: turn off fog. Value 6-255: the fog output changes from 1%-100%.

- When the LCD screen displays “READY TO FOG”, keep pressing the **MANUAL** button can force machine generate 100% full fog output. Once releasing **MANUAL** button, machine stops fogging immediately.

◆ Wireless Controller(W-2)

This fixture will allow you to control it by using the wireless remote. It consists of the transmitter and the receiver. You may control up to 4 independent fog machines, or many more if you want to run them simultaneously.

See the below instruction to operate your fog machine with the wireless controller:

- Plug the wired receiver into the fog machine.
- There are 4 buttons on the wireless remote transmitter which act as triggers. Each button can be assigned to a different fog machine. You may only choose 1 DIP switch on each receiver. See the below configuration for setting the receivers to operate with the transmitter remote.

MODE	DIP SWITCH	
Ch1	1=On,	2-4=Off
Ch2	2=On,	1,3,4=Off
Ch3	3=On,	1,2,4=Off
Ch4	4=On,	1,2,3=Off

- Press the button, and the fog machine will create fog momentarily for as long as you hold down the button.

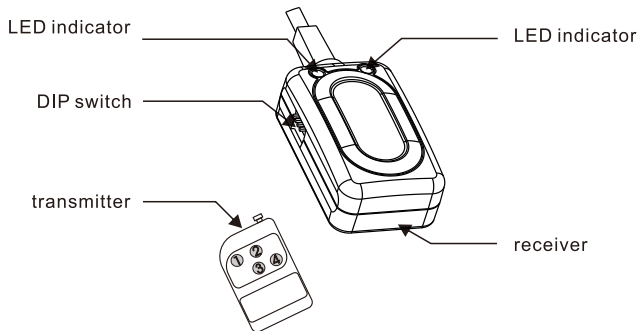

◆ **Technical parameters**

Model:	DF-3000S
Voltage:	AC 220 V - 240 V, 50/60 Hz
Breaker:	10 A/250 V
Power:	1,800 W
Heat-up Time:	5 min
Output:	35,000 cuft/min
Fluid Consumption Rate:	175.4 mL/min
Wireless Remote Controller:	W-2
DMX-512:	✓
Tank Capacity:	9 L
N. W. :	14 kg
G. W. :	16 kg
Machine Size:	638 x 359 x 275 mm
Package Size:	700 x 375 x 335 mm

◆ **Product Overview**

1. Safety Loop
2. Handle
3. Nozzle
4. Hanging bracket
5. Feet
6. Knob
7. Tube
8. 3-pin DMX Socket
9. Power switch
10. Power cord
11. Overload protector
12. LCD display
13. Control panel
14. Transmitter connector

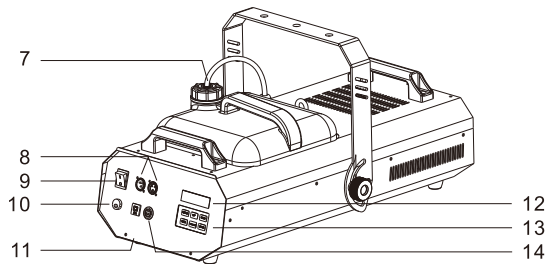
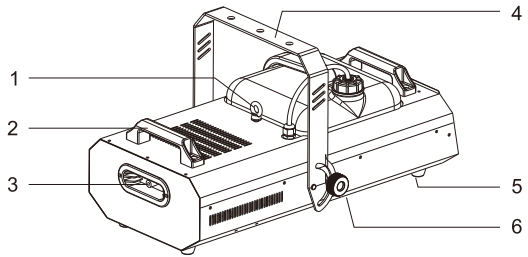

◆ Fog machine fluid blowout and heater blocking phenomenon analysis

Please use the original consumables, protect your health and life of machine

A.Fluid injection trouble: Refers to the fog fluid atomizing in the heater pipe of the machine is not good, heater temperature cannot be timely and effective transmit to the fog fluid, fog fluid cannot all atomization and lead to fluid injection

First reason: Using the low quality or counterfeit fog fluid, low quality fog fluid have more impurities, easy to adhere to the pipe wall and hindered temperature transmission result in incomplete atomization caused fluid injection.

Second reason: using an incorrect fog fluid. Different fog fluid have different required atomization temperature. If you use the wrong fog fluid result in fluid cannot fully atomization caused fluid injection.(fig 1)

B.Heater blocking trouble : poor atomization fluid injection is the early signs of heater block. Using poor quality fog fluid or not timely maintenance cleaning the fog machine for a long time. Inevitable will appear the terminal symptom of heater blocking.

Reason: heater blocked is because used inferior fog fluid or not maintenance for a long time. Have nothing to do with the quality of machine. Like a car with poor quality gasoline produce poor fluid circuit failure or long-time no maintenance the car will inevitably appear bigger problems. (fig 2)

C.Solutions to these problems: fog machine heating pipes used for a long time and then the pipe wall will easily produce sediments (The more inferior fog fluid the more impurities thus lead to fluid injection or blocked). All fog machines need regular maintenance (fog machine maintenance cycle for 1 to 2 months/time). Specific maintenance method: after heating the 35% white vinegar plus 65% distilled water and then spray 10 to 15 times

Conclusion: As long as the fog machine with fluid injection or heater blocking after using a period of time. It was caused by fog fluid quality or lack of maintenance, has nothing to do with the quality of the machine. Please use the original high quality fog fluid and timely maintain it, then it can be used for a long time.

Pipeline has covered by dirt, insufficient heat transfer result in water-spraying.

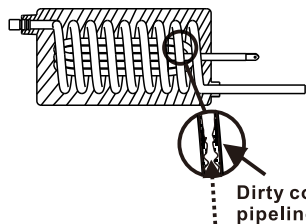

Fluid can not receive all heat.

Fig 1

Pipeline has covered by dirt, that results in blocked heater.

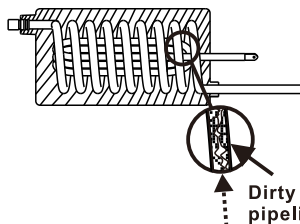

Fluid can not pass.

Fig 2

