

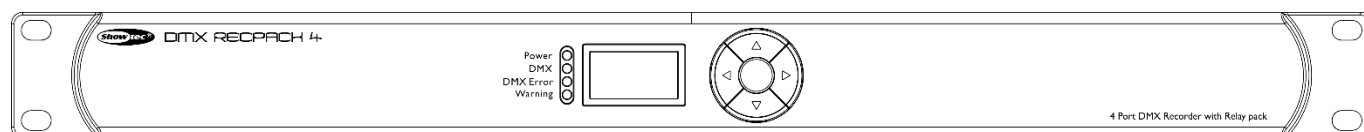

# MANUAL



ENGLISH

## DMX Recpack 4

V1

Ordercode: 50822

## Table of contents

<b>Warning</b> .....	3
Safety Instructions .....	3
Operating Determinations .....	4
Connection with the mains .....	5
Return Procedure .....	5
Claims .....	5
<b>Description of the device</b> .....	6
Frontside .....	6
Backside .....	7
<b>Installation</b> .....	7
<b>Set Up and Operation</b> .....	8
Data Cabling .....	8
Control Panel .....	9
Control Mode .....	9
Main Menu Options .....	10
1. Source .....	10
1.1. Scene .....	11
1.1.1. Record Scene .....	11
1.1.2. Play Scene .....	12
1.1.3. Delete Scene .....	13
1.2. Chase .....	13
1.2.1. Add Chase .....	13
1.2.2. Play Chase .....	14
1.2.3. Delete Chase .....	15
1.3. Show .....	16
1.3.1. Record Show .....	16
1.3.2. Play Show .....	17
1.3.3. Delete Show .....	18
2. Trigger .....	19
2.1. Add DMX TR .....	19
2.2. Edit & Del DMX TR .....	20
2.3. Add Daily TR .....	20
2.4. Edit & Del Daily TR .....	21
2.5. Add Weekly TR .....	22
2.6. Edit & Del Weekly TR .....	22
3. Action .....	23
3.1. Add Action .....	23
3.2. Edit & Del Action .....	25
3.3. Stop Action .....	25
4. Voltage Current .....	25
5. DMX Ports Status .....	26
6. Clear Warning .....	26
7. Device Settings .....	26
7.1. Set Date & Time .....	27
7.2. Set Max Current .....	27
7.3. Set OLED Option .....	27
7.4. Set Buzzer .....	28
7.5. View Device Label .....	28
7.6. View Version .....	28
8. Backup Data .....	29
9. Restore Data .....	29
10. Default Setting .....	30
<b>Maintenance</b> .....	30
Replacing the Fuse .....	30

**Troubleshooting** .....30  
    No Light .....30  
    No Response to DMX.....31  
**Product Specifications** .....32  
**Notes** .....33

## Warning



**For your own safety, please read this user manual carefully  
before your initial start-up!**



### Unpacking Instructions

Immediately upon receiving this product, carefully unpack the carton and check the contents to ensure that all parts are present, and have been received in good condition. Notify the dealer immediately and retain packing material for inspection if any parts appear damaged from shipping or the carton itself shows signs of mishandling. Save the carton and all packing materials. In the event that a fixture must be returned to the factory, it is important that the fixture be returned in the original factory box and packing.

### Your shipment includes:

- Showtec DMX Recpack 4
- Pro power cable (1,5 m)
- User manual

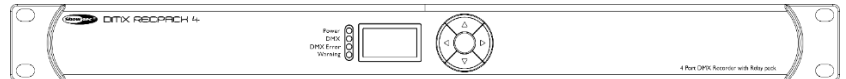

**CAUTION!**  
**Keep this device away from rain and moisture!**  
**Unplug mains lead before opening the housing!**



### Safety Instructions

Every person involved with the installation, operation and maintenance of this device has to:

- be qualified
- follow the instructions of this manual



**CAUTION! Be careful with your operations.**  
**With a dangerous voltage you can suffer  
a dangerous electric shock when touching the wires!**



Before your initial start-up, please make sure that there is no damage caused by transportation. Should there be any, consult your dealer and do not use the device.

To maintain perfect condition and to ensure a safe operation, it is absolutely necessary for the user to follow the safety instructions and warning notes written in this manual.

Please consider that damages caused by manual modifications to the device are not subject to warranty.

This device contains no user-serviceable parts. Refer servicing to qualified technicians only.

**IMPORTANT:**

The manufacturer will not accept liability for any resulting damages caused by the non-observance of this manual or any unauthorized modification to the device.

- Never let the power cord come into contact with other cables! Handle the power cord and all connections with the mains with particular caution!
- Never remove warning or informative labels from the unit.
- Never use anything to cover the ground contact.
- Never leave any cables lying around.
- Do not connect this device to a dimmer pack.
- Do not switch the device on and off in short intervals, as this would reduce the device's life.
- Do not touch the device's housing bare-handed during its operation. Allow the fixture to cool for at least 5 minutes before handling.
- Do not shake the device. Avoid brute force when installing or operating the device.
- Only use device indoors, avoid contact with water or other liquids.
- Only operate the fixture after having checked that the housing is firmly closed and all screws are tightly fastened.
- Only operate the device after having familiarized with its functions.
- Avoid flames and do not put close to flammable liquids or gases.
- Always keep case closed while operating.
- Always allow free air space of at least 50 cm around the unit for ventilation.
- Always disconnect power from the mains, when device is not used or before cleaning! Only handle the power cord by the plug. Never pull out the plug by tugging the power cord.
- Make sure that the device is not exposed to extreme heat, moisture or dust.
- Make sure that the available voltage is not higher than stated on the rear panel.
- Make sure that the power cord is never crimped or damaged. Check the device and the power cord from time to time.
- If the lens is obviously damaged, it has to be replaced, so that its functions are not impaired due to cracks or deep scratches.
- If device is dropped or struck, disconnect mains power supply immediately. Have a qualified engineer inspect for safety before operating.
- If the device has been exposed to drastic temperature fluctuation (e.g. after transportation), do not switch it on immediately. The arising condensation water might damage your device. Leave the device switched off until it has reached room temperature.
- If your Showtec device fails to work properly, discontinue use immediately. Pack the unit securely (preferably in the original packing material), and return it to your Showtec dealer for service.
- For adult use only. Device must be installed out of the reach of children. Never leave the unit running unattended.
- Never attempt to bypass the thermostatic switch or fuses.
- The user is responsible for correct positioning and operating of the DMX Recpack. The manufacturer will not accept liability for damages caused by the misuse or incorrect installation of this device.
- This device falls under protection class I. Therefore it is essential to connect the yellow/green conductor to earth.
- Repairs, servicing and electric connection must be carried out by a qualified technician.
- **WARRANTY:** Till one year after date of purchase.

**Operating Determinations**

- This device is not designed for permanent operation. Consistent operation breaks will ensure that the device will serve you for a long time without defects.
- To eliminate wear and improve lifespan, during periods of non-use, completely disconnect from power via breaker or by unplugging.
- The maximum ambient temperature  $t_a = 40^\circ\text{C}$  must never be exceeded.
- The relative humidity must not exceed 50 % with an ambient temperature of  $40^\circ\text{C}$ .
- If this device is operated in any other way, than the one described in this manual, the product may suffer damages and the warranty becomes void.
- Any other operation may lead to dangers like short-circuit, burns, electric shock, crash etc.

*You endanger your own safety and the safety of others!*

**Connection with the mains**

Connect the device to the mains with the power-plug.

Always pay attention, that the right color cable is connected to the right place.

International	EU Cable	UK Cable	US Cable	Pin
L	BROWN	RED	YELLOW/COPPER	PHASE
N	BLUE	BLACK	SILVER	NULL
	YELLOW/GREEN	GREEN	GREEN	EARTH

*Make sure that the device is always connected properly to the earth!*

**Return Procedure**

Returned merchandise must be sent prepaid and in the original packing, call tags will not be issued. Package must be clearly labeled with a Return Authorization Number (RMA number). Products returned without an RMA number will be refused. Highlite will not accept the returned goods or any responsibility. Call Highlite 0031-455667723 or mail [aftersales@highlite.nl](mailto:aftersales@highlite.nl) and request an RMA prior to shipping the fixture. Be prepared to provide the model number, serial number and a brief description of the cause for the return. Be sure to properly pack fixture, any shipping damage resulting from inadequate packaging is the customer's responsibility. Highlite reserves the right to use its own discretion to repair or replace product(s). As a suggestion, proper UPS packing or double-boxing is always a safe method to use.

**Note: If you are given an RMA number, please include the following information on a piece of paper inside the box:**

- 01) Your name
- 02) Your address
- 03) Your phone number
- 04) A brief description of the symptoms

**Claims**

The client has the obligation to check the delivered goods immediately upon delivery for any shortcomings and/or visible defects, or perform this check after our announcement that the goods are at their disposal. Damage incurred in shipping is the responsibility of the shipper; therefore the damage must be reported to the carrier upon receipt of merchandise.

It is the customer's responsibility to notify and submit claims with the shipper in the event that a fixture is damaged due to shipping. Transportation damage has to be reported to us within one day after receipt of the delivery.

Any return shipment has to be made post-paid at all times. Return shipments must be accompanied with a letter defining the reason for return shipment. Non-prepaid return shipments will be refused, unless otherwise agreed in writing.

Complaints against us must be made known in writing or by fax within 10 working days after receipt of the invoice. After this period complaints will not be handled anymore.

Complaints will only then be considered if the client has so far complied with all parts of the agreement, regardless of the agreement of which the obligation is resulting.

## Description of the device

### Features

The Showtec DMX Recpack 4 is a combination of a DMX recorder, a switch pack and a programmable trigger with timer function. It has 4 individual programmable DMX and switch outputs. Each DMX output can play pre-recorded scenes or shows. The device is equipped with 4 switchable 230V outputs. Each 230V output has its own individual current monitor which can be limited to a personal maximum current. Scenes, shows, chases and switches can be triggered by DMX or by weekly and daily timers. The user-definable DMX triggers make it possible to start and stop DMX or activate/deactivate it at specific channel values. The Showtec DMX Recpack is a solution for automation of intelligent lights, in combination with all kinds of electric devices. The ideal unit for shops, theme parks, museums and all other situations with the need for pre-programmed and triggered shows.

- Input voltage: 100-240V AC, 50/60Hz
- Power consumption @full load: 3450W
- 4 programmable DMX outputs
- 4 programmable output switches
- Power output: 15A/channel; 15A max total
- Control protocol: DMX-512
- Internal memory: 8GB
- Connections: 1 x 3-pin XLR IN; 1 x 3-pin XLR THROUGH; 4 x 3-pin XLR OUT
- Power connections: Pro power connector Blue IN/Gray OUT
- IP rating: IP-20
- Dimensions: 483 x 145 x 44,5 mm (LxWxH)  
19 inch x 1HE (LxH)
- Weight: 2,4 kg

### Frontside

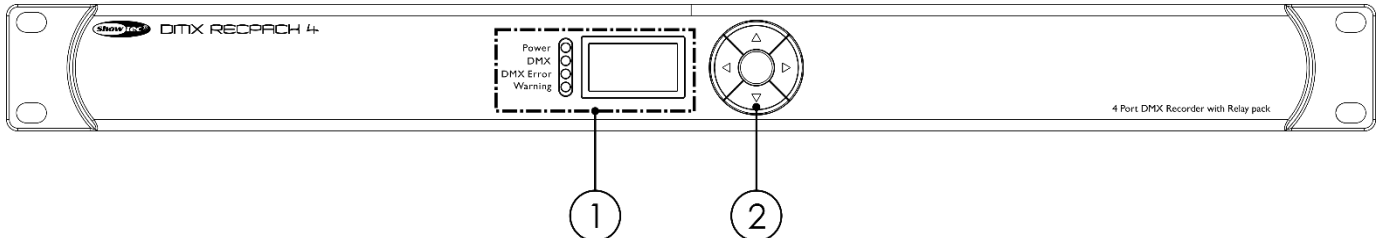

Fig. 01

#### 01) OLED display + LED indicators

- Red LED: power indicator
- Green LED: DMX indicator
- Yellow LED: DMX error indicator
- White LED: warning indicator

#### 02) Control buttons

## Backside

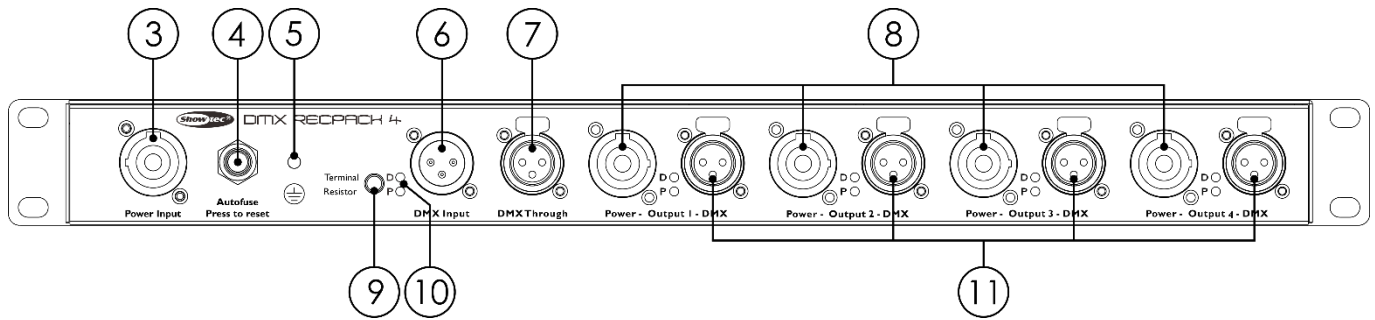

Fig. 02

- 03) **100-240V Pro power connector Blue IN**
- 04) **Automatic fuse**
- 05) **Ground/earth connection**
- 06) **3-pin DMX signal connector IN**  
Connect a light controller.
- 07) **3pin DMX signal connector THROUGH**  
Connect a light fixture.
- 08) **100-240V Pro power connector Gray OUT (outputs 1-4)**
- 09) **Data switch ON/OFF**  
Press the button to enable (green LED ON) or disable (green LED OFF) DMX data flow.
- 10) **(D)ata/(P)ower LED indicators**
- 11) **3-pin DMX signal connector OUT (outputs 1-4)**  
Connect a light fixture.

## Installation

Remove all packing materials from the DMX Recpack 4. Check that all foam and plastic padding is removed. Fit the equipment to a 19" rack. Connect all cables.

**Do not supply power before the whole system is set up and connected properly.**

**Always disconnect from electric mains power supply before cleaning or servicing.**

**Damages caused by non-observance are not subject to warranty.**



## Set Up and Operation

Follow the directions below, as they pertain to your preferred operation mode. Before plugging the unit in, always make sure that the power supply matches the product specification voltage. Do not attempt to operate a 120V specification product on 230V power, or vice versa.

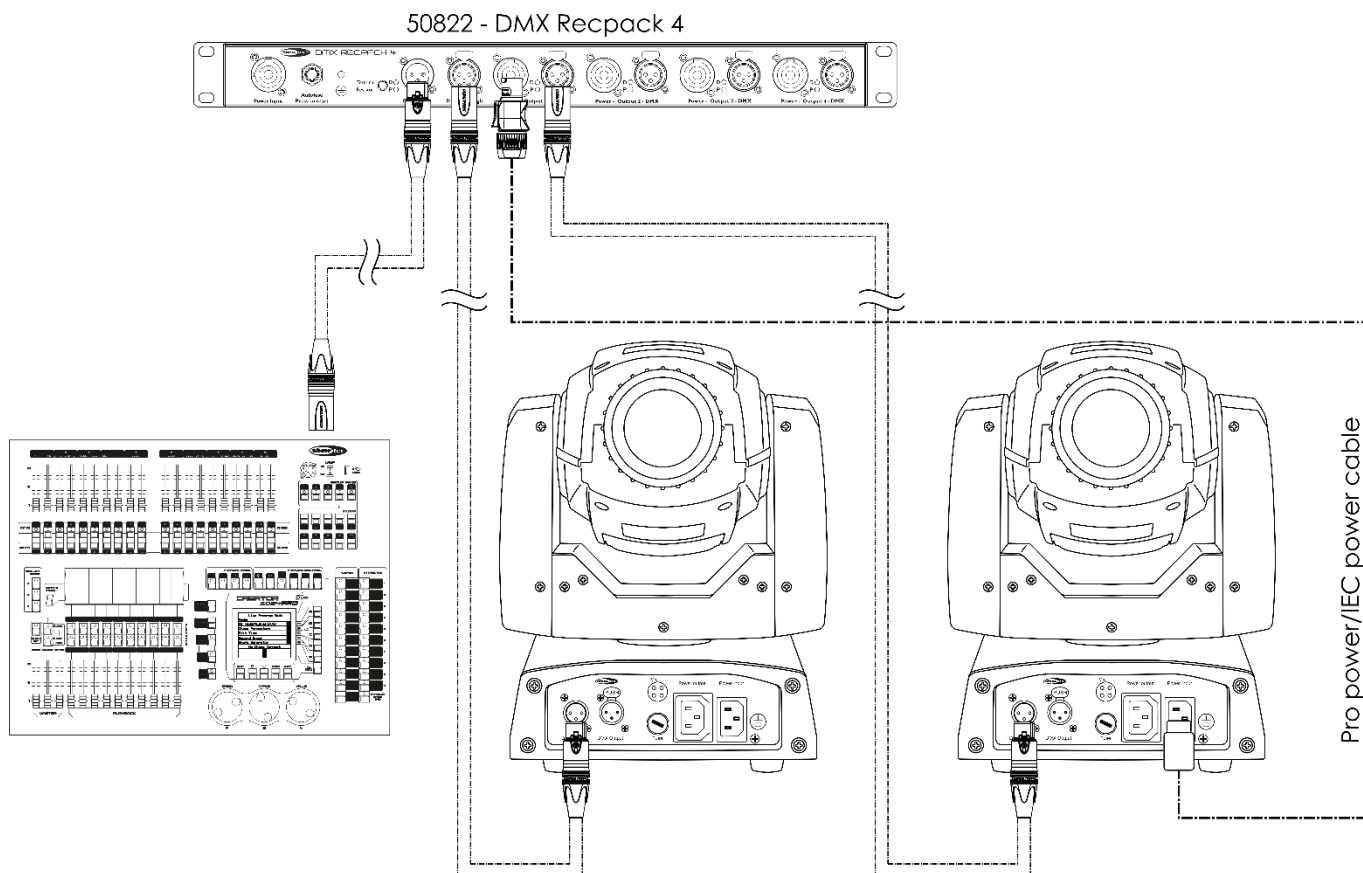

Fig. 03

**Note : Link all cables before connecting electric power**

### Data Cabling

To link fixtures together you must obtain data cables. You can purchase DAP Audio certified DMX cables directly from a dealer/distributor or construct your own cable. If you choose to create your own cable please use data-grade cables that can carry a high quality signal and are less prone to electromagnetic interference.

#### DAP Audio DMX Data Cables

- DAP Audio Basic microphone cable for allround use. bal. XLR/M 3-pin > XLR/F 3-pin. **Ordercode** FL01150 (1,5 m), FL013 (3 m), FL016 (6 m), FL0110 (10 m), FL0115 (15 m), FL0120 (20 m).
- DAP Audio X-type data cable XLR/M 3-pin > XLR/F 3-pin. **Ordercode** FLX0175 (0,75 m), FLX01150 (1,5 m), FLX013 (3 m), FLX016 (6 m), FLX0110 (10 m).
- DAP Audio cable for the demanding user with exceptional audio-qualities and connector made by Neutrik®. **Ordercode** FL71150 (1,5 m), FL713 (3 m), FL716 (6 m), FL7110 (10 m).
- DAP Audio cable for the demanding user with exceptional audio-qualities and connector made by Neutrik®. **Ordercode** FL7275 (0,75 m), FL72150 (1,5 m), FL723 (3 m), FL726 (6 m), FL7210 (10 m).
- DAP Audio 110 Ohm cable with digital signal transmission. **Ordercode** FL0975 (0,75 m), FL09150 (1,5 m), FL093 (3 m), FL096 (6 m), FL0910 (10 m), FL0915 (15 m), FL0920 (20 m).

## Control Panel

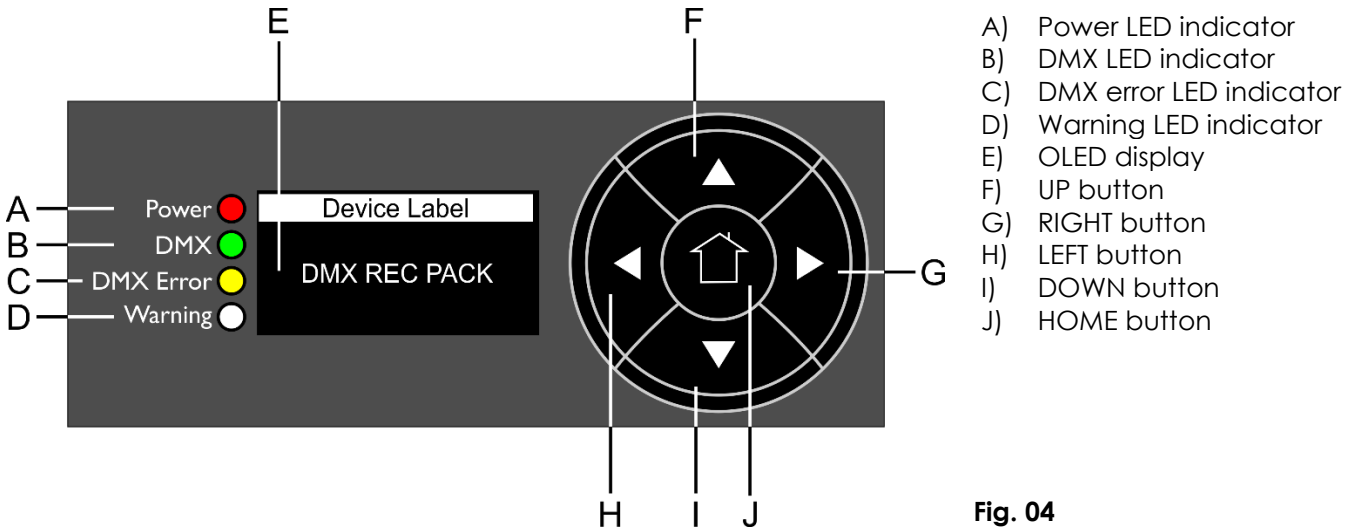

Fig. 04

## Control Mode

The fixture is individually addressed on a data-link and connected to the controller.

### Controlling:

After having addressed the DMX Recpack fixture, you may now start operating these via your light controller.

**Note:** After switching on, the DMX Recpack will automatically detect whether DMX-512 data is received or not. If there is no data received at the DMX-input, the "LED " on the control panel will not flash.

If not, the problem may be:

- The XLR cable from the controller is not connected with the input of the DMX Recpack.
- The controller is switched off or defective, the cable or connector is defective, or the signal wires are swapped in the input connector.

**Main Menu Options**

01) Upon start-up, the device will show the start screen:



02) Press the **HOME** button to enter main menu. The display will show:

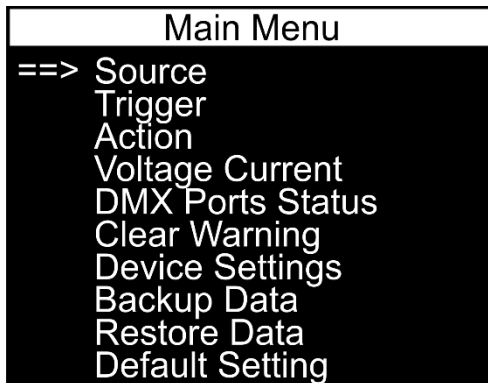

1. Source
2. Trigger
3. Action
4. Voltage Current
5. DMX Ports Status
6. Clear Warning
7. Device Settings
8. Backup Data
9. Restore Data
10. Default Setting

03) Press the **UP/DOWN** buttons to toggle through the 10 menus.

04) Press the **RIGHT** or **HOME** button to open the desired menu.

05) Press the **LEFT** button to return to the previous menu.

**1. Source**

In this menu you can create scenes, chases and record shows.

01) The display will show:

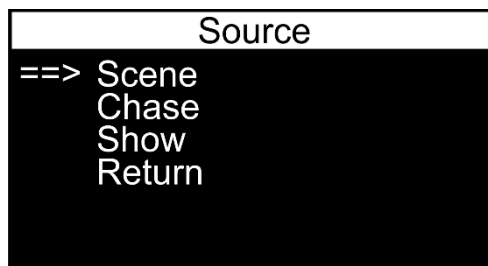

02) Press the **UP/DOWN** buttons to toggle through the 3 options. The available menus are:

- SCENE
- CHASE
- SHOW

03) Press the **RIGHT** or **HOME** button to enter the desired option.

04) Press the **LEFT** button to return to the previous menu (or press the **UP/DOWN** buttons to select RETURN and press the **RIGHT** or **HOME** button to confirm).

**1.1. Scene**

01) If you have chosen SCENE, the display will show:

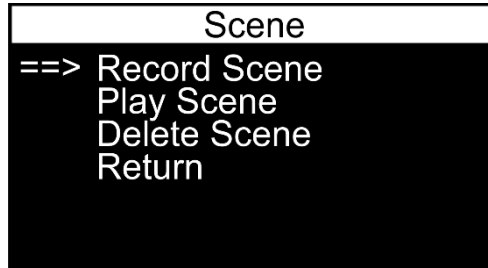

02) Press the **UP/DOWN** buttons to toggle through the 3 options. The available menus are:

- RECORD SCENE
- PLAY SCENE
- DELETE SCENE

03) Press the **RIGHT** or **HOME** button to enter the desired option.

04) Press the **LEFT** button to return to the previous menu (or press the **UP/DOWN** buttons to select RETURN and press the **RIGHT** or **HOME** button to confirm).

**1.1.1. Record Scene**

In this menu you can record a scene.

01) The display will show:

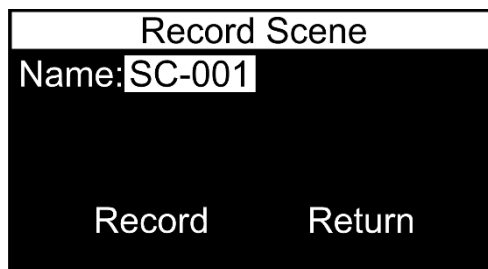

02) Press the **UP/DOWN** buttons to select NAME and press the **HOME** button to edit the scene name. The display will show:

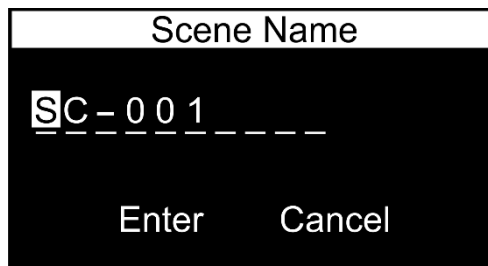

03) Press the **LEFT/RIGHT** buttons to select the character which you would like to edit and press the **HOME** button.

04) Press (or press and hold down, for quick search) the **UP/DOWN** buttons to select the desired character and press the **RIGHT** or **HOME** button to confirm your choice. Repeat this step to edit the other characters.

05) Once you have renamed the file, press the **UP/DOWN/LEFT/RIGHT** buttons to select CANCEL (to discard changes) or ENTER (to confirm the new scene name). Press the **HOME** button to confirm your choice.

06) Press the **UP/DOWN/LEFT/RIGHT** buttons to select RECORD (to record a scene) or RETURN (to return to the previous menu) and press the **HOME** button to confirm your choice.

**1.1.2. Play Scene**

In this menu you can play the recorded scenes.

01) The display will show:

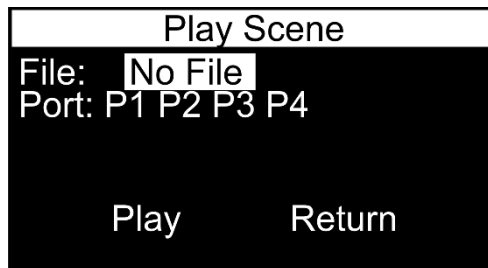

02) Press the **UP/DOWN** buttons to select FILE and press the **HOME** button to enter the menu.  
The display will show:

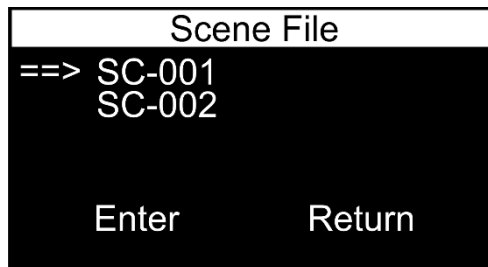

03) Press the **UP/DOWN** buttons to select the desired scene file.

04) Press the **RIGHT** or **HOME** button to confirm your choice.

05) Press the **LEFT/RIGHT** buttons to select ENTER (to confirm your choice) or RETURN (to discard your choice). The display will show:

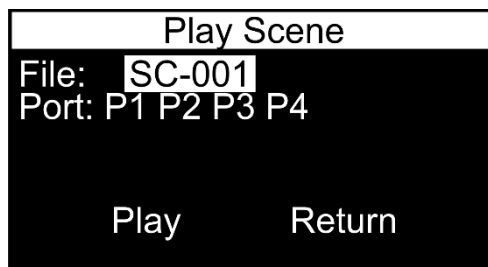

06) Press the **UP/DOWN** buttons to select PORT and press the **HOME** button to open the menu.  
The display will show:

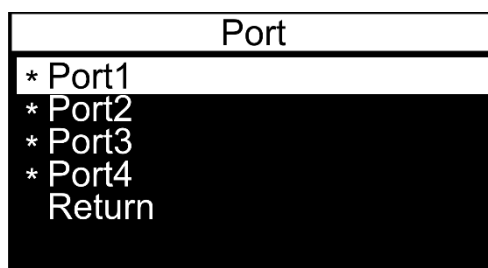

07) Press the **UP/DOWN** buttons to select the desired port and press the **RIGHT** button to activate/deactivate the port. Press the **UP/DOWN** buttons to select RETURN and press the **RIGHT** or **HOME** button to return to the previous menu.

08) Once you have chosen the scene file and adjusted the ports, press the **UP/DOWN/LEFT/RIGHT** buttons to select PLAY (to play the scene) or RETURN (to return to the previous menu) and press the **HOME** button to confirm your choice.

**1.1.3. Delete Scene**

In this menu you can delete scenes.

01) The display will show:

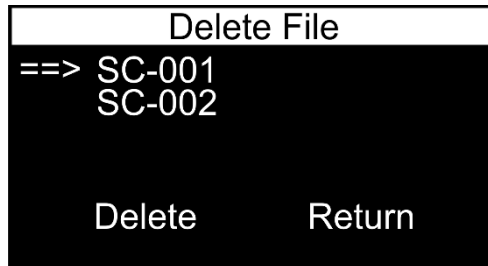

02) Press the **UP/DOWN** buttons to select the desired scene file.

03) Press the **RIGHT** or **HOME** button to confirm your choice.

04) Press the **LEFT/RIGHT** buttons to select DELETE (to delete the desired scene) or RETURN (to discard your choice).

05) Press the **HOME** button to confirm your choice.

**1.2. Chase**

01) If you have chosen CHASE, the display will show:

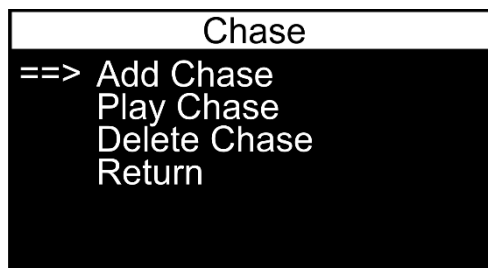

02) Press the **UP/DOWN** buttons to toggle through the 3 options. The available menus are:

- ADD CHASE
- PLAY CHASE
- DELETE CHASE

03) Press the **RIGHT** or **HOME** button to enter the desired submenu.

04) Press the **LEFT** button to return to the previous menu (or press the **UP/DOWN** buttons to select RETURN and press the **RIGHT** or **HOME** button to confirm).

**1.2.1. Add Chase**

In this menu you can store a chase.

01) The display will show:

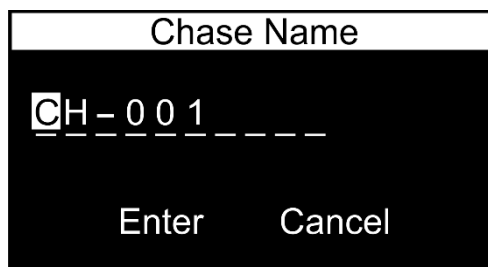

02) Press the **LEFT/RIGHT** buttons to select the character which you would like to edit and press the **HOME** button.

03) Press (or press and hold down, for quick search) the **UP/DOWN** buttons to select the desired character and press the **RIGHT** or **HOME** button to confirm your choice. Repeat this step to edit the other characters.

04) Once you have renamed the file, press the **UP/DOWN/LEFT/RIGHT** buttons to select CANCEL (to discard changes) or ENTER (to confirm the new chase name). Press the **HOME** button to confirm your choice.

05) If you have chosen ENTER, the display will show:

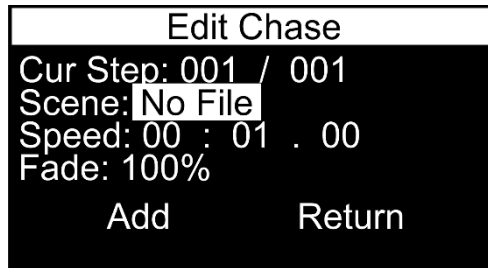

06) Press the **UP/DOWN** buttons to toggle through the following options:

- CUR STEP: currently selected scene and the total number of steps. This menu is not selectable and cannot be edited.
- SCENE: select the desired scene
- SPEED: scene duration (minutes/seconds/milliseconds)
- FADE: fade speed, from slow to fast

07) Once you have selected the desired option, press the **HOME** button to enter edition mode.

08) Press the **UP/DOWN** buttons to adjust values/choose options and press the **HOME** button to confirm changes.

09) Once you have adjusted all the settings, press the **UP/DOWN** buttons to select ADD (to add a scene) or RETURN (to return to the previous menu) and press the **HOME** button to confirm your choice.

10) Repeat steps 6-9 to add multiple scenes to the chase.

11) Once you have added all the desired scenes, select RETURN and press the **HOME** button to return to the previous menu. Your chase has been saved.

### 1.2.2. Play Chase

In this menu you can play chase files.

01) The display will show:

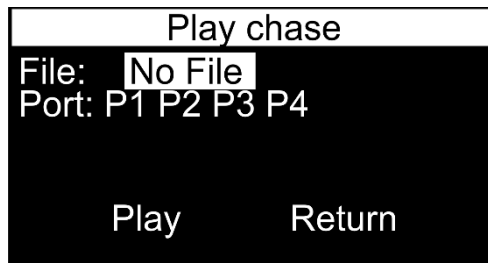

02) Press the **UP/DOWN** buttons to select FILE and press the **HOME** button to enter the menu. The display will show:

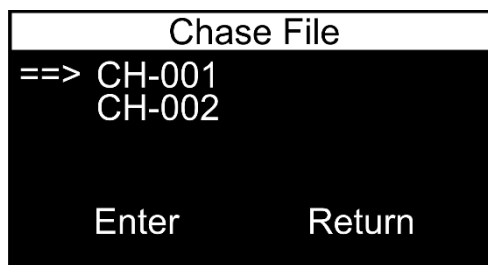

03) Press the **UP/DOWN** buttons to select the desired chase file.

04) Press the **RIGHT** or **HOME** button to confirm your choice.

- 05) Press the **LEFT/RIGHT** buttons to select ENTER (to confirm your choice) or RETURN (to discard your choice). The display will show:

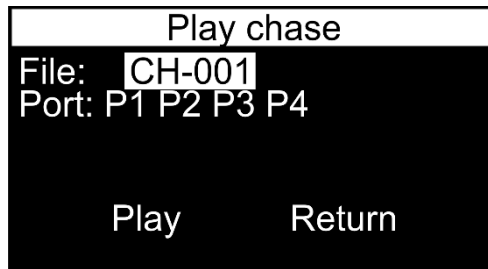

- 06) Press the **UP/DOWN** buttons to select PORT and press the **HOME** button to open the menu. The display will show:

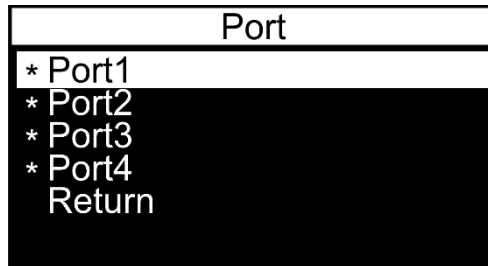

- 07) Press the **UP/DOWN** buttons to select the desired port and press the **RIGHT** button to activate/deactivate the port. Press the **UP/DOWN** buttons to select RETURN and press the **RIGHT** or **HOME** button to return to the previous menu.
- 08) Once you have chosen the chase file and adjusted the ports, select RETURN and press the **HOME** button to confirm.
- 09) Press the **UP/DOWN/LEFT/RIGHT** buttons to select PLAY (to play the chase) or RETURN (to return to the previous menu) and press the **HOME** button to confirm your choice.
- 10) Press the **HOME** button again, to stop playback.

### 1.2.3. Delete Chase

In this menu you can delete chases.

- 01) The display will show:

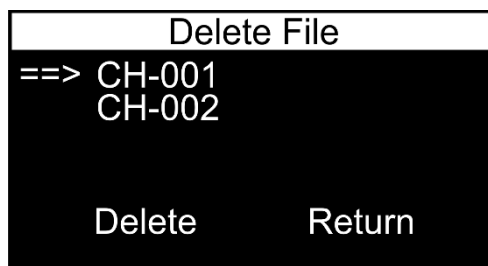

- 02) Press the **UP/DOWN** buttons to select the desired chase file.
- 03) Press the **RIGHT** or **HOME** button to confirm your choice.
- 04) Press the **LEFT/RIGHT** buttons to select DELETE (to delete the desired chase) or RETURN (to discard your choice).
- 05) Press the **HOME** button to confirm your choice.



**1.3. Show**

01) If you have chosen SHOW, the display will show:



02) Press the **UP/DOWN** buttons to toggle through the 3 options. The available menus are:

- RECORD SHOW
- PLAY SHOW
- DELETE SHOW

03) Press the **RIGHT** or **HOME** button to enter the desired option.

04) Press the **LEFT** button to return to the previous menu (or press the **UP/DOWN** buttons to select RETURN and press the **RIGHT** or **HOME** button to confirm).

**1.3.1. Record Show**

In this menu you can record a show.

01) The display will show:

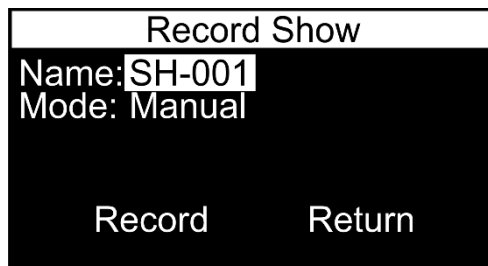

02) Press the **UP/DOWN** buttons to select NAME and press the **HOME** button to edit the show name. The display will show:

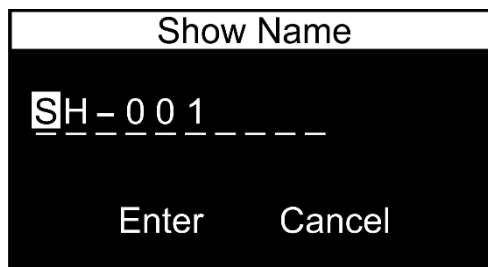

03) Press the **LEFT/RIGHT** buttons to select the character which you would like to edit and press the **HOME** button.

04) Press (or press and hold down, for quick search) the **UP/DOWN** buttons to select the desired character and press the **RIGHT** or **HOME** button to confirm your choice. Repeat this step to edit the other characters.

05) Once you have renamed the file, press the **UP/DOWN/LEFT/RIGHT** buttons to select CANCEL (to discard changes) or ENTER (to confirm the new show name). Press the **HOME** button to confirm your choice.

06) Press the **UP/DOWN** buttons to select MODE and press the **HOME** button to enter recording mode selection. There are 3 options:

- MANUAL: manually start and stop recording
- SEMI\_AUTO: recording can be triggered via DMX but needs to be stopped manually
- AUTO: recording can be triggered via DMX and can be stopped by choosing blackout, via DMX

07) Press the **UP/DOWN** buttons to select the desired mode and press the **HOME** button to confirm your choice.

- 08) Press the **UP/DOWN/LEFT/RIGHT** buttons to select RECORD (to record a show) or RETURN (to return to the previous menu) and press the **HOME** button to confirm your choice. If you have chosen RECORD, the display will show:

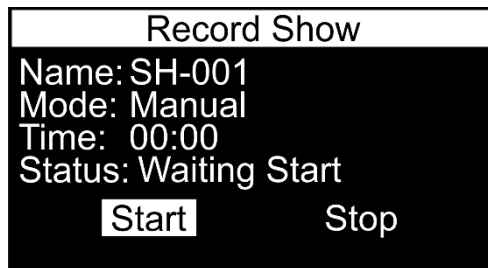

- 09) If the status is WAITING START, press the **LEFT/RIGHT** buttons to select START (to start recording) or STOP (to cancel recording) and press the **HOME** button to confirm.
- 10) Press the **LEFT/RIGHT** buttons to select PAUSE or STOP and press the **HOME** button to confirm your choice. The recorded show will now be saved.

### 1.3.2. Play Show

In this menu you can play the recorded shows.

- 01) The display will show:

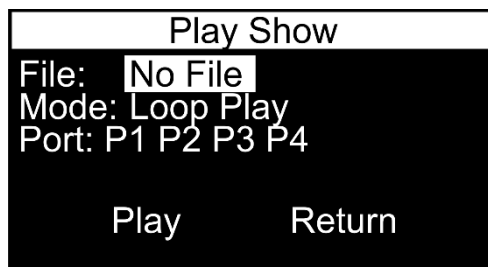

- 02) Press the **UP/DOWN** buttons to select FILE and press the **HOME** button to enter the menu. The display will show:

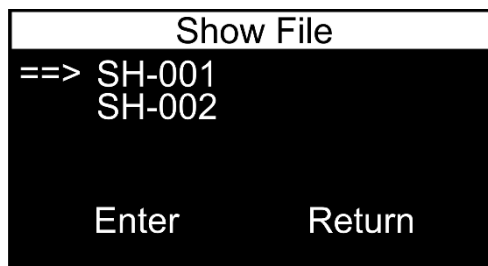

- 03) Press the **UP/DOWN** buttons to select the desired show file.
- 04) Press the **RIGHT** or **HOME** button to confirm your choice.
- 05) Press the **LEFT/RIGHT** buttons to select ENTER (to confirm your choice) or RETURN (to discard your choice). The display will show:

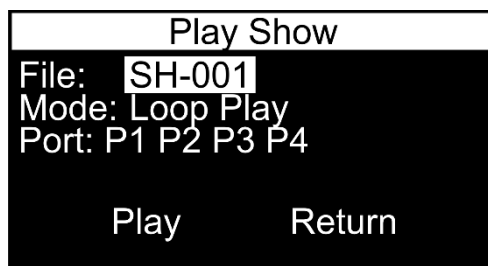

- 06) Press the **UP/DOWN** buttons to select MODE and press the **HOME** button to open the menu.
- 07) Press the **UP/DOWN** buttons to choose one of the 2 play modes:
  - ONE PLAY: single play
  - LOOP PLAY: show will be repeated in a loop
- 08) Press the **HOME** button to confirm your choice.
- 09) Press the **UP/DOWN** buttons to select PORT and press the **HOME** button to open the menu. The display will show:

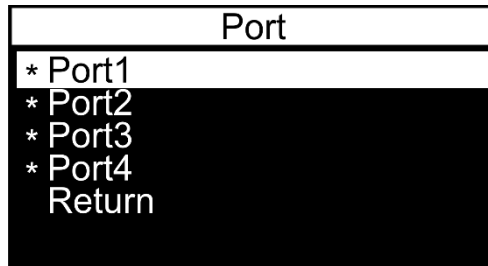

- 10) Press the **UP/DOWN** buttons to select the desired port and press the **RIGHT** button to activate/deactivate the port. Press the **UP/DOWN** buttons to select RETURN and press the **RIGHT** or **HOME** button to return to the previous menu.
- 11) Once you have chosen the show file and adjusted the ports, select RETURN and press the **HOME** button to confirm.
- 12) Press the **UP/DOWN/LEFT/RIGHT** buttons to select PLAY (to play the show) or RETURN (to return to the previous menu) and press the **HOME** button to confirm your choice.
- 13) Press the **HOME** button again, to stop playback.

### 1.3.3. Delete Show

In this menu you can delete shows.

- 01) The display will show:

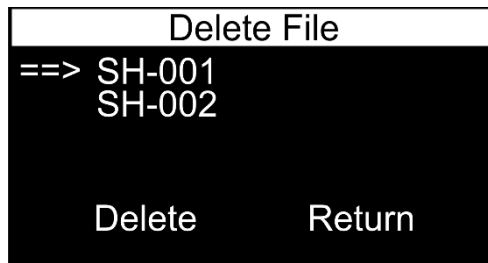

- 02) Press the **UP/DOWN** buttons to select the desired show file.
- 03) Press the **RIGHT** or **HOME** button to confirm your choice.
- 04) Press the **LEFT/RIGHT** buttons to select DELETE (to delete the desired show) or RETURN (to discard your choice).
- 05) Press the **HOME** button to confirm your choice.

**2. Trigger**

In this menu you can set the triggers.

01) The display will show:

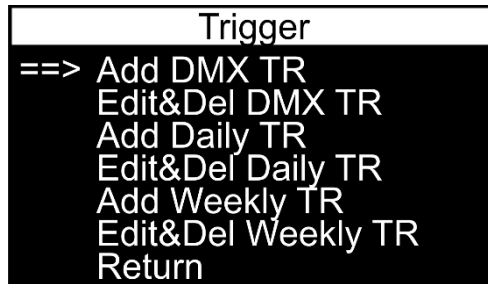

02) Press the **UP/DOWN** buttons to select one of the 6 options:

- ADD DMX TR: DMX trigger
- EDIT & DEL DMX TR: edit/delete a DMX trigger
- ADD DAILY TR: daily trigger
- EDIT & DEL DAILY TR: edit/delete a daily trigger
- ADD WEEKLY TR: weekly trigger
- EDIT & DEL WEEKLY TR: edit/delete a weekly trigger

03) Press the **RIGHT** or **HOME** button to enter the desired menu.

04) Press the **LEFT** button to return to the previous menu (or press the **UP/DOWN** buttons to select RETURN and press the **RIGHT** or **HOME** button to confirm).

**2.1. Add DMX TR**

In this menu you can set a DMX trigger.

01) The display will show:

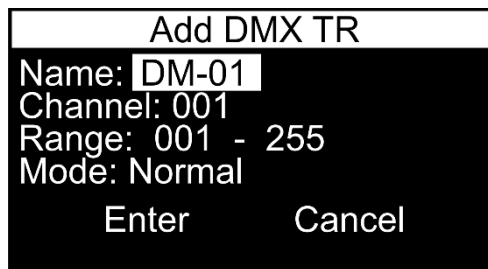

02) Press the **UP/DOWN** buttons to select NAME and press the **HOME** button to edit the trigger name. The display will show:

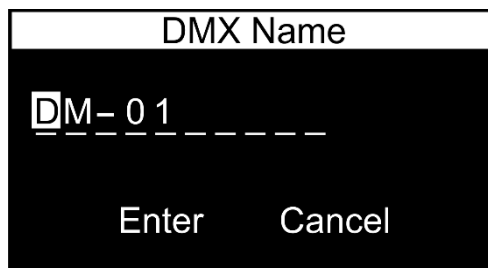

03) Press the **LEFT/RIGHT** buttons to select the character which you would like to edit and press the **HOME** button.

04) Press (or press and hold down, for quick search) the **UP/DOWN** buttons to select the desired character and press the **RIGHT** or **HOME** button to confirm your choice. Repeat this step to edit the other characters.

05) Once you have renamed the file, press the **UP/DOWN/LEFT/RIGHT** buttons to select CANCEL (to discard changes) or ENTER (to confirm the new trigger name). Press the **HOME** button to confirm your choice.

- 06) Press the **UP/DOWN** buttons to select CHANNEL and press the **HOME** button to enter the menu. Press (or press and hold down, for quick search) the **UP/DOWN** buttons to select the desired DMX channel. The adjustment range is between 000-512. Press the **HOME** button to save changes.
- 07) Press the **UP/DOWN** buttons to select RANGE. Press the **LEFT/RIGHT** buttons to select the starting point or the endpoint of the channel range and press the **HOME** button to enter edition. Press (or press and hold down, for quick search) the **UP/DOWN** buttons to set the desired value. The adjustment range is between 000-255. Press the **HOME** button to save changes.
- 08) Press the **UP/DOWN** buttons to select MODE. Press the **HOME** button to enter the menu. Press the **UP/DOWN** buttons to choose one of the 2 options:
  - **NORMAL**: trigger remains active as long as the device receives a DMX signal
  - **LATCH**: trigger remains active even when there is no DMX signal anymore
- 09) Press the **HOME** button to confirm your choice.
- 10) Press the **UP/DOWN/LEFT/RIGHT** buttons to select CANCEL (to discard changes) or ENTER (to save the trigger). Press the **HOME** button to confirm your choice.

## 2.2. Edit & Del DMX TR

In this menu you can edit and delete the existing DMX triggers.

- 01) The display will show:

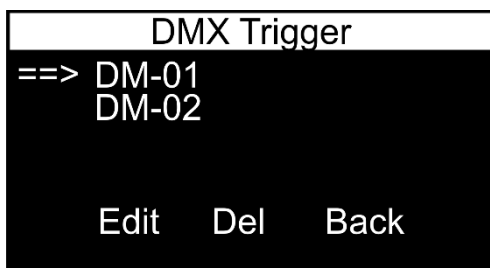

- 02) Press the **UP/DOWN** buttons to select the desired trigger file.
- 03) Press the **RIGHT** or **HOME** button to confirm your choice.
- 04) Press the **LEFT/RIGHT** buttons to select EDIT (to edit the trigger file), DEL (to delete the trigger file) or BACK (to discard your choice and return to the previous menu).
- 05) Press the **HOME** button to confirm your choice.
- 06) If you have chosen EDIT, the device will allow you to edit the already existing DMX trigger file's settings.
- 07) Follow the instructions from 2.1. Add DMX TR (page 19) to edit.

## 2.3. Add Daily TR

In this menu you can set a daily trigger.

- 01) The display will show:

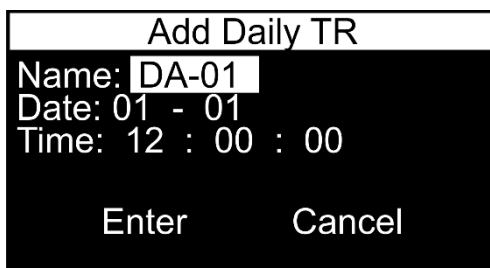

- 02) Press the **UP/DOWN** buttons to select NAME and press the **HOME** button to edit the trigger name. The display will show:

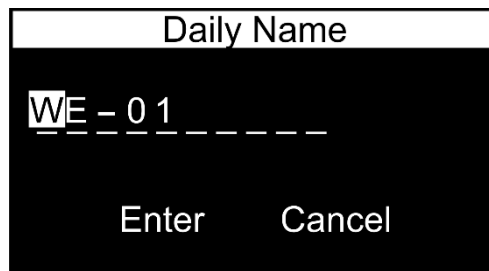

- 03) Press the **LEFT/RIGHT** buttons to select the character which you would like to edit and press the **HOME** button.
- 04) Press (or press and hold down, for quick search) the **UP/DOWN** buttons to select the desired character and press the **RIGHT** or **HOME** button to confirm your choice. Repeat this step to edit the other characters.
- 05) Once you have renamed the file, press the **UP/DOWN/LEFT/RIGHT** buttons to select CANCEL (to discard changes) or ENTER (to confirm the new trigger name). Press the **HOME** button to confirm your choice.
- 06) Press the **UP/DOWN** buttons to select DATE. Press the **LEFT/RIGHT** buttons to select the date (month/day) when the trigger will be activated and press the **HOME** button to enter edition. Press (or press and hold down, for quick search) the **UP/DOWN** buttons to set the desired month or day. The adjustment range is between 00-12 (months) and 00-31 (days). Press the **HOME** button to save changes.
- 07) Press the **UP/DOWN** buttons to select TIME. Press the **LEFT/RIGHT** buttons to select the time (hour/minutes/seconds) when the trigger will be activated and press the **HOME** button to enter edition. Press (or press and hold down, for quick search) the **UP/DOWN** buttons to set the desired values. The adjustment range is between 00-23 (hours) and 00-59 (minutes and seconds). Press the **HOME** button to save changes.
- 08) Press the **UP/DOWN/LEFT/RIGHT** buttons to select CANCEL (to discard changes) or ENTER (to save the trigger). Press the **HOME** button to confirm your choice.

#### 2.4. Edit & Del Daily TR

In this menu you can edit and delete the existing daily triggers.

01) The display will show:

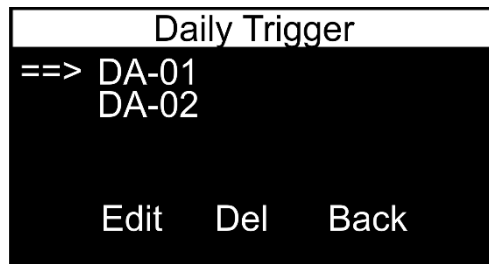

- 02) Press the **UP/DOWN** buttons to select the desired trigger file.
- 03) Press the **RIGHT** or **HOME** button to confirm your choice.
- 04) Press the **LEFT/RIGHT** buttons to select EDIT (to edit the trigger file), DEL (to delete the trigger file) or BACK (to discard your choice and return to the previous menu).
- 05) Press the **HOME** button to confirm your choice.
- 06) If you have chosen EDIT, the device will allow you to edit the already existing daily trigger file's settings.
- 07) Follow the instructions from 2.3. Add Daily TR (page 20) to edit.

## 2.5. Add Weekly TR

In this menu you can set a weekly trigger.

01) The display will show:

02) Press the **UP/DOWN** buttons to select NAME and press the **HOME** button to edit the trigger name. The display will show:

03) Press the **LEFT/RIGHT** buttons to select the character which you would like to edit and press the **HOME** button.

04) Press (or press and hold down, for quick search) the **UP/DOWN** buttons to select the desired character and press the **RIGHT** or **HOME** button to confirm your choice. Repeat this step to edit the other characters.

05) Once you have renamed the file, press the **UP/DOWN/LEFT/RIGHT** buttons to select CANCEL (to discard changes) or ENTER (to confirm the new trigger name). Press the **HOME** button to confirm your choice.

06) Press the **UP/DOWN** buttons to select TIME. Press the **LEFT/RIGHT** buttons to select the time (hour/minutes/seconds) when the trigger will be activated and press the **HOME** button to enter edition. Press (or press and hold down, for quick search) the **UP/DOWN** buttons to set the desired values. The adjustment range is between 00-23 (hours) and 00-59 (minutes and seconds). Press the **HOME** button to save changes.

07) Press the **UP/DOWN** buttons to select REP. Press the **UP/DOWN/LEFT/RIGHT** buttons to select DAYS (to select all days) or select MON, TUE, WED, THU, FRI, SAT and SUN (to select single days).

08) Press the **UP/DOWN/LEFT/RIGHT** buttons to select CANCEL (to discard changes) or ENTER (to save the trigger). Press the **HOME** button to confirm your choice.

## 2.6. Edit & Del Weekly TR

In this menu you can edit and delete the existing weekly triggers.

01) The display will show:

02) Press the **UP/DOWN** buttons to select the desired trigger file.

03) Press the **RIGHT** or **HOME** button to confirm your choice.

04) Press the **LEFT/RIGHT** buttons to select EDIT (to edit the trigger file), DEL (to delete the trigger file) or BACK (to discard your choice and return to the previous menu).

05) Press the **HOME** button to confirm your choice.

- 06) If you have chosen EDIT, the device will allow you to edit the already existing weekly trigger file's settings.
- 07) Follow the instructions from 2.5. Add Weekly TR (page 22) to edit.

**3. Action**

In this menu you can manually play your DMX files.

- 01) The display will show:

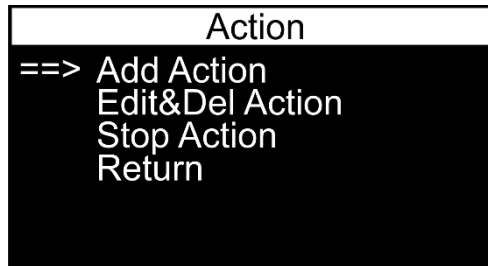

- 02) Press the **UP/DOWN** buttons to select one of the 3 options:
- ADD ACTION: set the desired action
  - EDIT & DEL ACTION: edit/delete the existing actions
  - STOP ACTION: stop the desired actions
- 03) Press the **RIGHT** or **HOME** button to enter the desired menu.
- 04) Press the **LEFT** button to return to the previous menu (or press the **UP/DOWN** buttons to select RETURN and press the **RIGHT** or **HOME** button to confirm).

**3.1. Add Action**

In this menu you can assign your programmed scenes, shows and chases to your preset triggers.

- 01) The display will show:

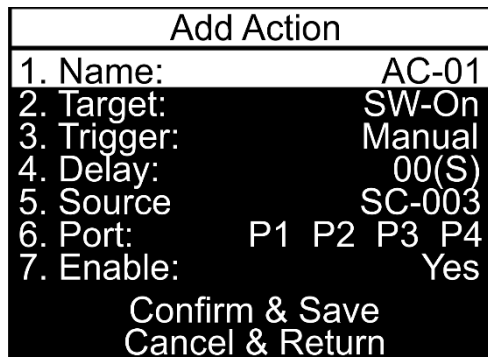

- 02) Press the **UP/DOWN** buttons to select NAME and press the **HOME** button to edit the action name. The display will show:

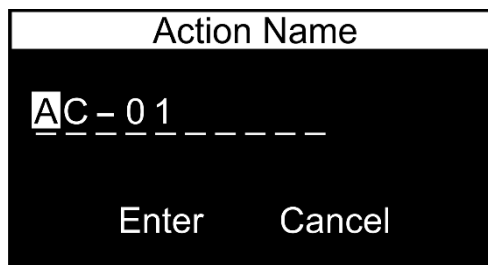

- 03) Press the **LEFT/RIGHT** buttons to select the character which you would like to edit and press the **HOME** button.
- 04) Press (or press and hold down, for quick search) the **UP/DOWN** buttons to select the desired character and press the **RIGHT** or **HOME** button to confirm your choice. Repeat this step to edit the other characters.



- 05) Once you have renamed the file, press the **UP/DOWN/LEFT/RIGHT** buttons to select CANCEL (to discard changes) or ENTER (to confirm the new action name). Press the **HOME** button to confirm your choice.
- 06) Press the **UP/DOWN** buttons to select TARGET and press the **RIGHT** or **HOME** button to open the menu.
- 07) Press the **UP/DOWN** buttons to select one of the 5 options:
  - STOP: stop playback
  - LOOP: play the desired file in a loop
  - SINGLE: play the desired file once
  - SW-OFF: switch the desired power port OFF
  - SW-ON: switch the desired power port ON
- 08) Press the **RIGHT** or **HOME** button to confirm your choice.
- 09) Press the **UP/DOWN** buttons to select TRIGGER and press the **RIGHT** or **HOME** button to open the menu. Press the **UP/DOWN** buttons to choose the sort of trigger you want to use: DMX trigger, daily trigger, weekly trigger or a manual trigger. Press the **RIGHT** or **HOME** button to confirm your choice. Press the **UP/DOWN** buttons to select the desired file and press the **RIGHT** or **HOME** button to confirm your choice. Press the **LEFT/RIGHT** buttons to select ENTER (to confirm) or RETURN (to discard your choice).
- 10) Press the **UP/DOWN** buttons to select DELAY and press the **RIGHT** or **HOME** button to open the menu. Press the **UP/DOWN** buttons to set a delay. The adjustment range is between 0-10 seconds. Press the **RIGHT** or **HOME** button to save changes.
- 11) Press the **UP/DOWN** buttons to select SOURCE and press the **RIGHT** or **HOME** button to open the menu. Press the **UP/DOWN** buttons to select the desired source: scene file, chase file, show file or incoming DMX signal. If you have chosen SCENE\_FILE, CHASE\_FILE or SHOW\_FILE, press the **RIGHT** or **HOME** button to open the menu. Press the **UP/DOWN** buttons to select the desired file and press the **RIGHT** or **HOME** button to confirm your choice. Press the **LEFT/RIGHT** buttons to select ENTER (to confirm) or RETURN (to discard your choice).
- 12) Press the **UP/DOWN** buttons to select PORT and press the **RIGHT** or **HOME** button to open the menu. The display will show:

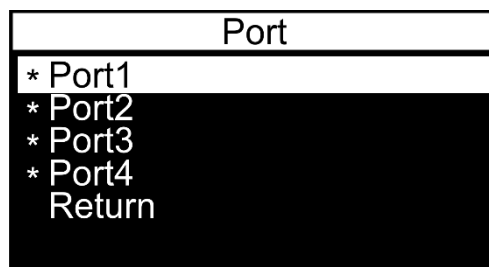

- 13) Press the **UP/DOWN** buttons to select the desired port and press the **RIGHT** button to activate/deactivate the port. Press the **UP/DOWN** buttons to select RETURN and press the **RIGHT** or **HOME** button to return to the previous menu.
- 14) Press the **UP/DOWN** buttons to select ENABLE and press the **RIGHT** or **HOME** button to open the menu. Press the **UP/DOWN** buttons to select YES or NO and press the **RIGHT** or **HOME** button to confirm your choice.
- 15) Once you have adjusted all the options, press the **UP/DOWN** buttons to select one of the 2 options:
  - CONFIRM & SAVE: to save the action
  - CANCEL & RETURN: to discard the action

**Note:** Please note that the option described in step 11 (SOURCE) will be visible/editable **only** if you choose **SINGLE** or **LOOP** in step 7 (see above).

**3.2. Edit & Del Action**

In this menu you can edit and delete the existing action files.

01) The display will show:

Name	Port	Stat
AC-01	[1234]	[A]
AC-02	[1234]	[A]

Edit   Del   Back

- 02) Press the **UP/DOWN** buttons to select the desired action file.
- 03) Press the **RIGHT** or **HOME** button to confirm your choice.
- 04) Press the **LEFT/RIGHT** buttons to select EDIT (to edit the action file), DEL (to delete the action file) or BACK (to discard your choice and return to the previous menu).
- 05) Press the **HOME** button to confirm your choice.
- 06) If you have chosen EDIT, the device will allow you to edit the already existing action file's settings.
- 07) Follow the instructions from 3.1. Add Action (page 23) to edit.

**3.3. Stop Action**

In this menu you can stop the desired actions.

01) The display will show:

Name	Port	Target
AC-01	[1234]	[S ON]
AC-02	[1234]	[S_ON]

Stop   All   Back

- 02) Press the **UP/DOWN** buttons to select the desired action file.
- 03) Press the **RIGHT** or **HOME** button to confirm your choice.
- 04) Press the **LEFT/RIGHT** buttons to select STOP (to stop the selected action file), ALL (to stop all action files) or BACK (to discard your choice and return to the previous menu).
- 05) Press the **HOME** button to confirm your choice.

**4. Voltage Current**

In this menu you can view the voltage present on each port.

01) The display will show:

Voltage Current				
	1	2	3	4
S	OFF	OFF	OFF	OFF
I	0.0	0.0	0.0	0.0

- 1-4: power ports
- S: port status (ON = power out is on, OFF = power out is off)
- I: output's current value (e.g. 0,5 means 0,5A current)

### 5. DMX Ports Status

In this menu you can view the currently active action and its status.

01) The display will show:

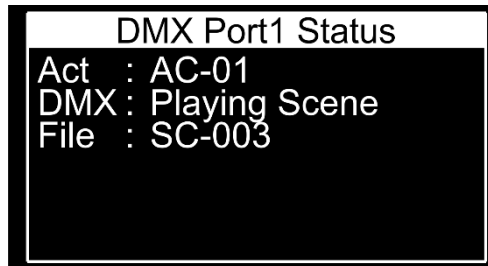

### 6. Clear Warning

In this menu you can see the status of each of the 4 ports. You can monitor if the ports are not overloaded.

01) The display will show:

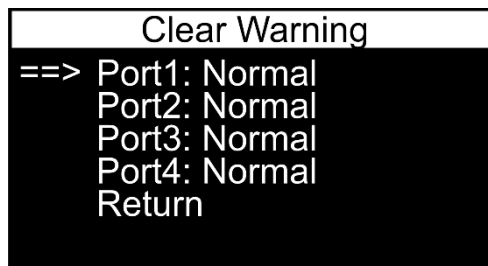

### 7. Device Settings

In this menu you can adjust the device's settings.

01) The display will show:

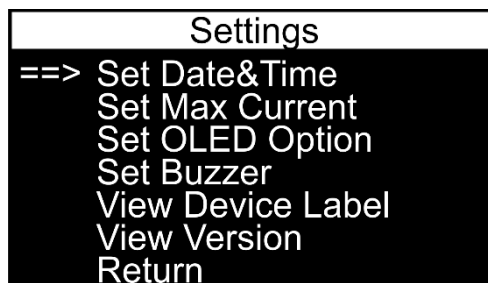

02) Press the UP/DOWN buttons to select one of the 6 options:

- SET DATE & TIME
- SET MAX CURRENT
- SET OLED OPTION
- SET BUZZER
- VIEW DEVICE LABEL
- VIEW VERSION

03) Press the **RIGHT** or **HOME** button to enter the desired menu.

04) Press the **LEFT** button to return to the previous menu (or press the **UP/DOWN** buttons to select RETURN and press the **RIGHT** or **HOME** button to confirm).

**7.1. Set Date & Time**

In this menu you can set the device's clock.

01) The display will show:

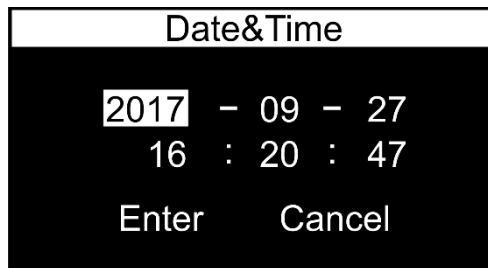

- 02) Press the **LEFT/RIGHT/UP/DOWN** buttons to select the year, month, day, hours, minutes or seconds.
- 03) Press the **HOME** button to enter edition mode.
- 04) Press (or press and hold down, for quick search) the **UP/DOWN** buttons to change the values.
- 05) Press the **HOME** button to confirm your choice.
- 06) Press the **LEFT/RIGHT/UP/DOWN** buttons to select CANCEL (to discard changes) or ENTER (to save changes).
- 07) Press the **HOME** button to confirm your choice.

**7.2. Set Max Current**

In this menu you can determine the maximum current on each port.

01) The display will show:

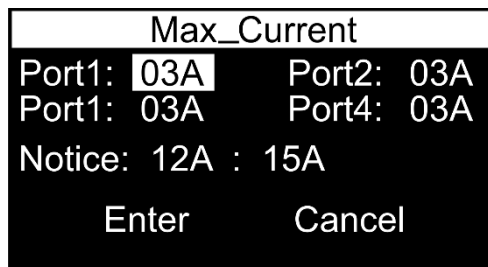

- 02) Press the **LEFT/RIGHT/UP/DOWN** buttons to select one of the 4 ports.
- 03) Press the **HOME** button to enter edition mode.
- 04) Press (or press and hold down, for quick search) the **UP/DOWN** buttons to change the values. The adjustment range is between 0-10A.
- 05) Press the **HOME** button to confirm your choice.
- 06) The total amperage should not exceed 15A. If it does, the device will inform you about that.
- 07) Press the **LEFT/RIGHT/UP/DOWN** buttons to select CANCEL (to discard changes) or ENTER (to save changes).
- 08) Press the **HOME** button to confirm your choice.

**7.3. Set OLED Option**

In this menu you can set how much time needs to pass before the display turns off, when no button is pressed.

01) The display will show:

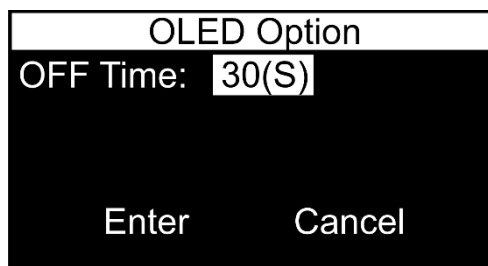

- 02) Press the **HOME** button to enter edition mode.
- 03) Press the **UP/DOWN** buttons to set the amount of time which needs to pass before the display turns off, when no button is pressed. The adjustment range is between 5 seconds and Always ON.

- 04) Press the **HOME** button to confirm your choice.
- 05) Press the **DOWN/LEFT/RIGHT** buttons to select CANCEL (to discard changes) or ENTER (to save changes) and press the **HOME** button to confirm your choice.

### 7.4. Set Buzzer

In this menu you can set a buzzer, which will inform you about any problems and malfunctions.

- 01) The display will show:

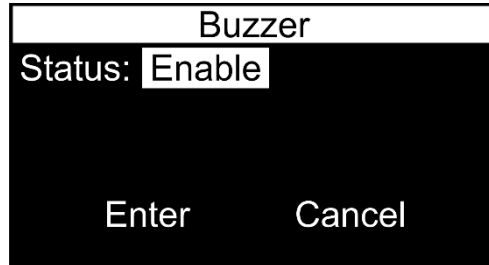

- 02) Press the **HOME** button to enter edition mode.
- 03) Press the **UP/DOWN** buttons to select ENABLE or DISABLE and press the **HOME** button to confirm your choice.
- 04) Press the **DOWN/LEFT/RIGHT** buttons to select CANCEL (to discard changes) or ENTER (to save changes) and press the **HOME** button to confirm your choice.

### 7.5. View Device Label

In this menu you can view the device's label.

- 01) The display will show:

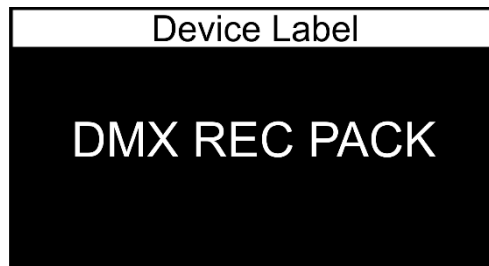

### 7.6. View Version

In this menu you can view the currently installed software version.

- 01) The display will show:

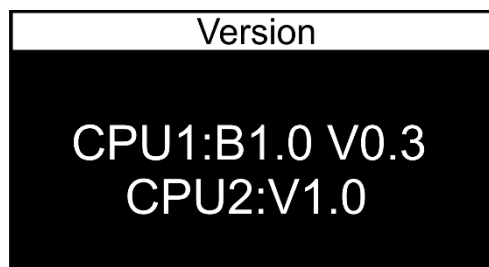

## 8. Backup Data

In this menu you can save the current device's settings as a backup file.

01) The display will show:

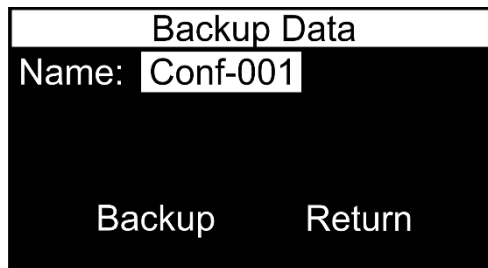

02) Press the **HOME** button to edit the filename. The display will show:

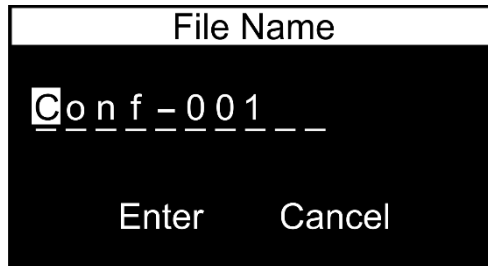

- 03) Press the **LEFT/RIGHT** buttons to select the character which you would like to edit and press the **HOME** button.
- 04) Press (or press and hold down, for quick search) the **UP/DOWN** buttons to select the desired character and press the **RIGHT** or **HOME** button to confirm your choice. Repeat this step to edit the other characters.
- 05) Once you have renamed the file, press the **UP/DOWN/LEFT/RIGHT** buttons to select CANCEL (to discard changes) or ENTER (to confirm the new filename). Press the **HOME** button to confirm your choice.
- 06) Press the **DOWN/LEFT/RIGHT** buttons to select BACKUP (to create a backup file) or RETURN (to return to the previous menu).
- 07) Press the **HOME** button to confirm your choice.

## 9. Restore Data

In this menu you can load the previously saved backup files, in order to restore the desired settings.

01) The display will show:

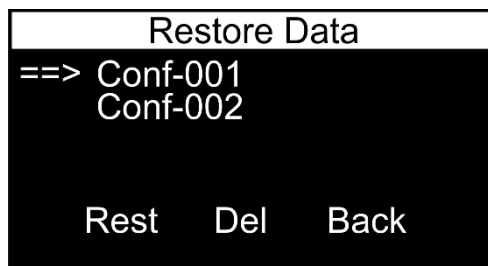

- 02) Press the **UP/DOWN** buttons to select the desired backup file.
- 03) Press the **RIGHT** or **HOME** button to confirm your choice.
- 04) Press the **LEFT/RIGHT** buttons to select REST (to load the backup file), DEL (to delete the backup file) or BACK (to discard your choice and return to the previous menu).
- 05) Press the **HOME** button to confirm your choice.

### 10. Default Setting

In this menu you can restore the default settings.

01) The display will show:

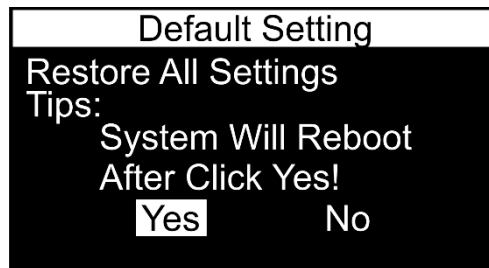

02) Press the **LEFT/RIGHT** buttons to select YES or NO.

03) Press the **HOME** button to confirm your choice.

## Maintenance

The Showtec DMX Recpack 4 requires almost no maintenance. However, you should keep the unit clean. Disconnect the mains power supply and then wipe the cover with a damp cloth. Wipe the front glass panel clean with glass cleaner and a soft cloth. Do not use alcohol or solvents. Do not immerse in liquid. Keep connections clean. Disconnect electric power, and then wipe the DMX and audio connections with a damp cloth. Make sure connections are thoroughly dry before linking equipment or supplying electric power.

The operator has to make sure that safety-related and machine-technical installations are to be inspected by an expert after every year in the course of an acceptance test.

The operator has to make sure that safety-related and machine-technical installations are to be inspected by a skilled person once a year.

The following points have to be considered during the inspection:

- 01) All screws used for installing the device or parts of the device have to be tightly connected and must not be corroded.
- 02) There may not be any deformations on housings, fixations and installation spots.
- 03) The electric power supply cables must not show any damages or material fatigue.

### Replacing the Fuse

You do not have to replace the fuse on this device as the fuse is automatic.

- 01) In case of a power surge, short-circuit or inappropriate power supply, press the reset button located on the rear of the device, and the device will function normally.
- 02) Try to determine the cause of the problem, so that the situation does not happen in the future.

## Troubleshooting

### No Light

This troubleshooting guide is meant to help solve simple problems.

If a problem occurs, carry out the steps below in sequence until a solution is found. Once the unit operates properly, do not carry out following steps.

If the device does not operate properly, refer servicing to a technician.

Suspect three potential problem areas as: the power supply, the LEDs or the fuse.

- 01) Power supply. Check if the unit is plugged into an appropriate power supply.
- 02) The LEDs. Return your light fixture to your dealer.
- 03) The fuse. See page 30 for replacing the fuse.
- 04) If all of the above appears to be O.K., plug the unit in again.
- 05) If you are unable to determine the cause of the problem, do not open the DMX Recpack, as this may damage the unit and the warranty will become void.
- 06) Return the device to your Showtec dealer.

**No Response to DMX**

Suspect the DMX cable or connectors, a controller malfunction, a light effect DMX card malfunction.

- 01) Check the DMX setting. Make sure that DMX addresses are correct.
- 02) Check the DMX cable: Unplug the unit; change the DMX cable; then reconnect to electrical power. Try your DMX control again.
- 03) Determine whether the DMX recorder, light controller or light effect is at fault. Does the controller operate properly with other DMX products ? If not, take the controller in for repair. If so, take the DMX cable and/or the light effect to a qualified technician.

<b>Problem</b>	<b>Probable cause(s)</b>	<b>Remedy</b>
The device does not function at all	No power to the device	<ul style="list-style-type: none"> <li>● Check if power is switched on and cables are plugged in</li> </ul>
Fixtures reset correctly, but all respond erratically or not at all to the controller	The controller is not connected	<ul style="list-style-type: none"> <li>● Connect controller</li> </ul>
	3-pin XLR Out of the device does not match XLR Out of the fixture on the link (i.e. signal is reversed)	<ul style="list-style-type: none"> <li>● Install a phase reversing cable between the controller and the first fixture on the link</li> </ul>
Fixtures reset correctly, but some respond erratically or not at all to the DMX trigger	Poor data quality	<ul style="list-style-type: none"> <li>● Check data quality. If much lower than 100 percent, the problem may be a bad data link connection, poor quality or broken cables, missing termination plug, or a defective fixture disturbing the link</li> </ul>
	Bad data link connection	<ul style="list-style-type: none"> <li>● Inspect connections and cables. Correct poor connections. Repair or replace damaged cables</li> </ul>
	Data link not terminated with 120 Ohm termination plug	<ul style="list-style-type: none"> <li>● Insert termination plug in output jack of the last fixture on the link</li> </ul>
	Incorrect addressing of the fixtures	<ul style="list-style-type: none"> <li>● Check address setting</li> </ul>
No light or LEDs/lamp cut out intermittently	3-pin XLR Out on the fixtures does not match (pins 2 and 3 reversed)	<ul style="list-style-type: none"> <li>● Install a phase-reversing cable between the fixtures or swap pins 2 and 3 in the fixture</li> </ul>
	Fixture is too hot	<ul style="list-style-type: none"> <li>● Allow fixture to cool down</li> <li>● Make sure air vents and front lens are not blocked</li> <li>● Turn up the air conditioning</li> </ul>
	LEDs/lamp damaged	<ul style="list-style-type: none"> <li>● Disconnect fixture and return to your dealer</li> </ul>
	The power supply settings do not match local AC voltage and frequency	<ul style="list-style-type: none"> <li>● Disconnect fixture. Check settings and correct if necessary</li> </ul>



**Product Specifications**

Model:	Showtec DMX Recpack 4
Input voltage:	100-240V AC, 50/60 Hz
Power consumption @full load:	3450W
Dimensions:	483 x 145 x 44,5 mm (LxWxH) 19 inch x 1HE (LxH)
Weight:	2,4 kg
<b>Operation and Programming</b>	
Signal pin OUT:	pin 1 earth, pin 2 (-), pin 3 (+)
Setup:	OLED display for easy setup
Signal input:	3-pin XLR IN
Signal output:	3-pin XLR OUT; 3-pin XLR THROUGH
<b>Electro-mechanical effects</b>	
Internal memory:	8GB
Outputs:	4 programmable DMX outputs
Output switches:	4 programmable output switches
Power output:	15A/channel; 15A max total
Control protocol:	DMX-512
Connections:	1 x 3-pin XLR IN; 1 x 3-pin XLR THROUGH; 4 x 3-pin XLR OUT
Power connections:	Pro power connector Blue IN/Gray OUT
IP rating:	IP-20
Max. ambient temperature $t_a$ :	40°C
Max. housing temperature $t_B$	70°C
<b>Minimum distance:</b>	
Minimum distance from flammable surfaces:	0,5 m

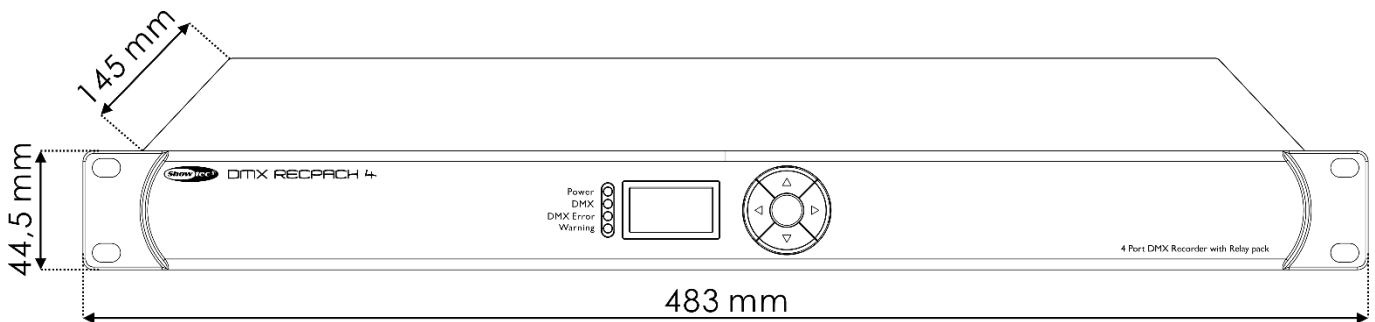

Design and product specifications are subject to change without prior notice.



Website: [www.Showtec.info](http://www.Showtec.info)  
Email: [service@highlite.nl](mailto:service@highlite.nl)







©2017 Showtec