

ASK nano

Wireless Presentation and Collaboration System

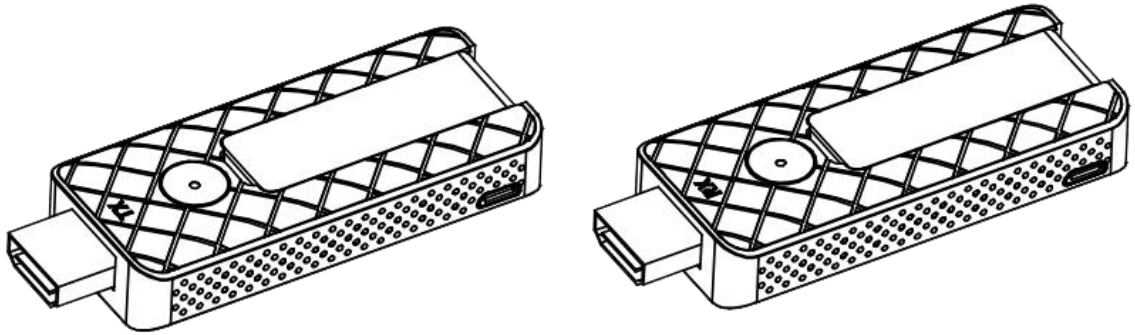

USER MANUAL

RGBlink®

Article No: RGB-RD-UM-ASK nano E001
Revision No: V1.1

Content

<i>Declarations</i>	3
FCC/Warranty.....	3
Operators Safety Summary.....	4
Installation Safety Summary.....	4
<i>Chapter 1 Your Product</i>	6
1.1 In the Box.....	6
1.2 Product Overview.....	7
1.2.1 Interface.....	7
<i>Chapter 2 Install Your Product</i>	9
2.1 Pairing of TX and RX.....	9
2.2 Receiver Installation.....	9
2.3 Transmitter Installation.....	10
<i>Chapter 3 Use Your Product</i>	11
3.1 MENU.....	11
3.1.1 Switch the Language.....	12
3.1.2 Add Wireless Network.....	12
3.1.3 Screen Position.....	13
3.1.4 Airplay Mode.....	13
3.1.5 Meeting Invitation.....	13
3.2 Computer Screen Projection by TX.....	14
3.3 Phone Screen Projection.....	14
3.3.1 Apple.....	14
3.3.2 Android.....	15
3.4 Single Screen Mode.....	16
3.5 Examples Demonstration of Screen Projection.....	17
<i>Chapter 4 Order Codes</i>	19
<i>Chapter 5 Support</i>	20
5.1 Contact Us.....	20
<i>Chapter 6 Appendix</i>	21
6.1 Specification.....	21
6.2 Terms & Definitions.....	22
6.3 Revision History.....	29

Thank you for choosing our product!

This User Manual is designed to show you how to use this video processor quickly and make use of all the features. Please read all directions and instructions carefully before using this product.

Declarations

FCC/Warranty

Federal Communications Commission (FCC)

Statement

This equipment has been tested and found to comply with the limits for a class A digital device, pursuant to Part 15 of the FCC rules. These limits are designed to provide reasonable protection against harmful interference when the equipment is operated in a commercial environment. This equipment generates, uses, and can radiate radio frequency energy and, if not installed and used in accordance with the instruction manual, may cause harmful interference to radio communications. Operation of this equipment in a residential area may cause harmful interference, in which case the user will be responsible for correcting any interference.

Guarantee and Compensation

RGBlink provides a guarantee relating to perfect manufacturing as part of the legally stipulated terms of guarantee. On receipt, the purchaser must immediately inspect all delivered goods for damage incurred during transport, as well as for material and manufacturing faults. RGBlink must be informed immediately in writing of any complains.

The period of guarantee begins on the date of transfer of risks, in the case of special systems and software on the date of commissioning, at latest 30 days after the transfer of risks. In the event of justified notice of compliant, RGBlink can repair the fault or provide a replacement at its own discretion within an appropriate period. If this measure proves to be impossible or unsuccessful, the purchaser can demand a reduction in the purchase price or cancellation of the contract. All other claims, in particular those relating to compensation for direct or indirect damage, and also damage attributed to the operation of software as well as to other service provided by RGBlink, being a component of the system or independent service, will be deemed invalid provided the damage is not proven to be attributed to the absence of properties guaranteed in writing or due to the intent or gross negligence or part of RGBlink.

If the purchaser or a third party carries out modifications or repairs on goods delivered by RGBlink, or if the goods are handled incorrectly, in particular if the systems are

commissioned operated incorrectly or if, after the transfer of risks, the goods are subject to influences not agreed upon in the contract, all guarantee claims of the purchaser will be rendered invalid. Not included in the guarantee coverage are system failures which are attributed to programs or special electronic circuitry provided by the purchaser, e.g. interfaces. Normal wear as well as normal maintenance are not subject to the guarantee provided by RGBlink either.

The environmental conditions as well as the servicing and maintenance regulations specified in this manual must be complied with by the customer.

Operators Safety Summary

The general safety information in this summary is for operating personnel.

Do Not Remove Covers or Panels

There are no user-serviceable parts within the unit. Removal of the top cover will expose dangerous voltages. To avoid personal injury, do not remove the top cover. Do not operate the unit without the cover installed.

Power Source

This product is powered by USB on TX end and DC 5V at RX end.

Do Not Operate in Explosive Atmospheres

To avoid explosion, do not operate this product in an explosive atmosphere.

Installation Safety Summary

Safety Precautions

For all ASK nano installation procedures, please observe the following important safety and handling rules to avoid damage to yourself and the equipment.

To protect users from electric shock, ensure that the chassis connects to earth via the ground wire provided in the AC power Cord.

The AC Socket-outlet should be installed near the equipment and be easily accessible.

Unpacking and Inspection

Before opening ASK nano processor shipping box, inspect it for damage. If you find any damage, notify the shipping carrier immediately for all claims adjustments. As you open the box, compare its contents against the packing slip. If you find any shortages, contact your sales representative.

Once you have removed all the components from their packaging and checked that all the listed components are present, visually inspect the system to ensure there was no damage during shipping. If there is damage, notify the shipping carrier immediately for all

claims adjustments.

Site Preparation

The environment in which you install your ASK nano should be clean, properly lit, free from static, and have adequate power, ventilation, and space for all components.

Chapter 1 Your Product

1.1 In the Box

Standard Accessories

Type C - HDMI
Adapter*1



micro USB Cable*2



HDMI
Adapter(female to
female)*2



2.4G Wireless
Cable*1



HDMI Cable(male to
female)*1



1.2 Product Overview

ASK nano is an intuitive and high efficiency wireless presentation and collaboration system that enables any meeting participant to simply share the content from their laptop, mobile phone, or tablet on the projector or large screen wirelessly, no APP required, no set up, no messy cables, just touch and share.

ASK nano also supports multicast, which is a group communication, where video transmission from one transmitter is addressed to a group of receivers simultaneously.



ASK nano System Connection Diagram

1.2.1 Interface

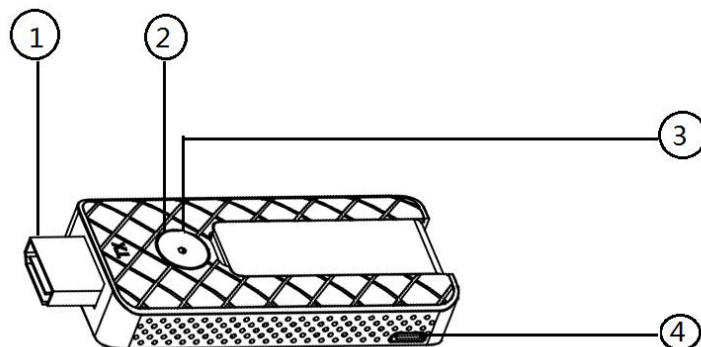

TX Illumination			
1	HDMI interface, connect display or projector	2	Projection key
3	Indicator light	4	Micro USB Power interface

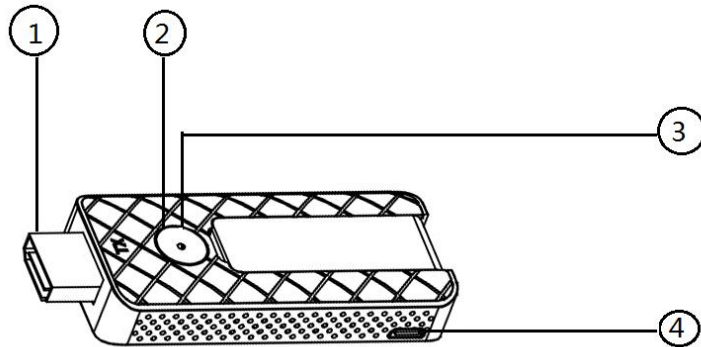

RX Illumination			
1	HDMI interface, connect display or projector	2	Mode switch key, switch TX/DLNA/AirPlay Mode and Miracast Mode
3	Indicator light	4	Micro USB power interface

Indicator light

TX	Illumination
Light Red	TX is opening
Flash Blue	Waiting for the connection
Static Blue	Successful connection and projection

RX	Illumination
Flash Blue	RX is power on and ready for projection

Chapter 2 Install Your Product

2.1 Pairing of TX and RX

Before delivery, each ASK nano set has been paired, but when extra TX are required, following steps are the method for users to finish TX/RX pairing.

(1) After RX and TX are both powered on (power RX up firstly), they will be pairing automatically. After pairing, the red indicator light on the TX will turn blue, and the corresponding screen on the RX will display the information of successful pairing; if there are more than one RX, TX will be pairing with the closest one.

(2) If you want to re-pair the paired ones, press the TX button for 5 seconds to clear the previous pairing information, and then you can re-pair them according to the above steps.

Note: ASK nano TX will auto pair to the most close ASK nano RX, so once you will do the pairs, please make sure the dedicated ASK nano RX to be closed to be paired ASK nano TX.

2.2 Receiver Installation

1. Power on the RX via microUSB to USB cable and power adapter.

2. Connect RX's HDMI port big screen, TV or projector.



Note: RX must be Powered on. Power adapter should be supported by users.

2.3 Transmitter Installation

1. Connect the TX's HDMI port to the PC's HDMI port.
2. The light turns from red to flashing blue when TX is ready for projection.
3. Touch the projection key and the indicator light turns static blue, which means the projection is successful.



Note: If projection is unsuccessful, unplug the TX, and supply power to TX's HDMI port via microUSB-USB cable and power adapter, then connect TX's HDMI port to the PC's HDMI port again, touch the projection key to project.

Chapter 3 Use Your Product

3.1 MENU

After RX is connected to big screen, the screen enters homepage, which will be set in English by default. Users can switch the language to English in web page menu.



The steps to enter the menu as follow:

1. Select and connect ASK nano RX's hotspot from the WIFI List in your mobile phone or computer;

RX hotspot name : ASK nano-XXXXXX; Password : 12345678;

2. After connection, type the IP address of RX in the web site bar on your phone or computer, as shown in the figure above: 192.168.43.1;

Note: In case of problems such as abnormal size of interface ICONS and blue background, users can clear browser data before entering the web page.

3. Enter the web menu.

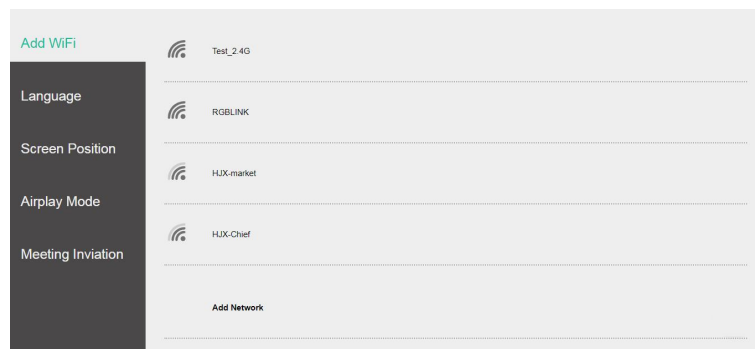

3.1.1 Switch the Language

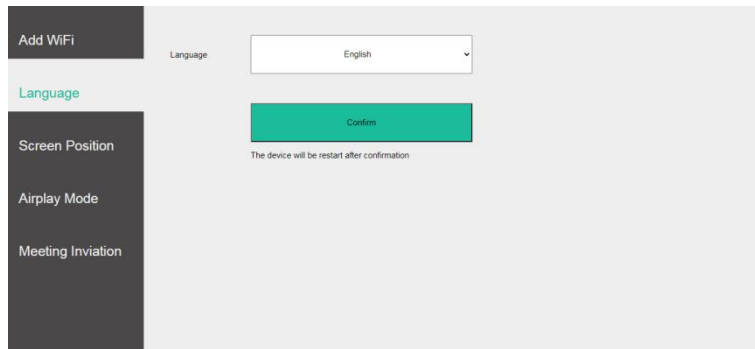

Click the Language bar and select Chinese from the drop-down menu. The device will restart automatically.

3.1.2 Add Wireless Network

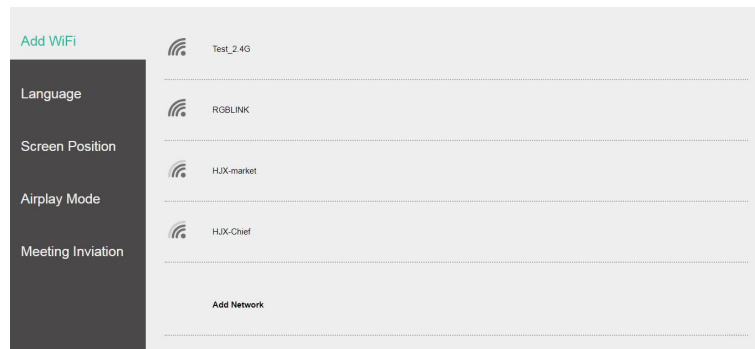

Click "Add WIFI" and select the network to be added from the WIFI list. After joining the network, the big screen of RX will show the name of the LAN and the IP address.

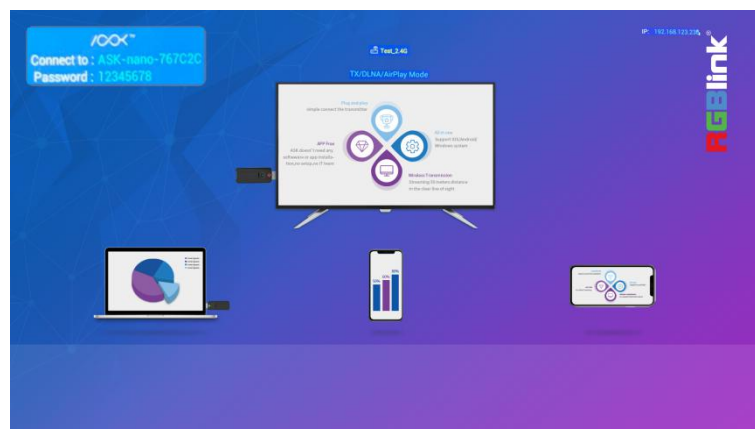

3.1.3 Screen Position

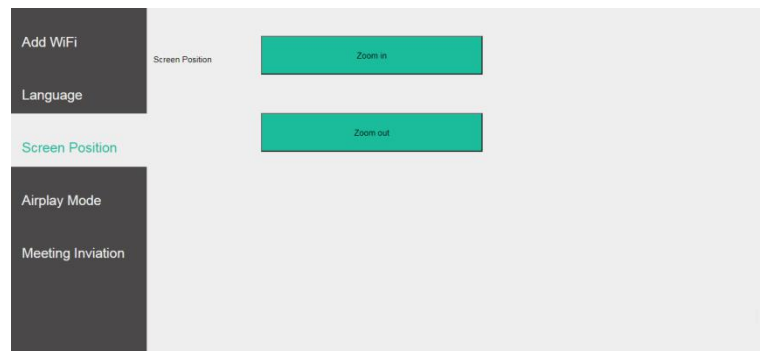

Click "Screen Position" to **zoom in** or **zoom out** the image of big screen.

3.1.4 Airplay Mode

For devices that support AirPlay, users can select the screen projection mode of "Mirror" or "Streaming."

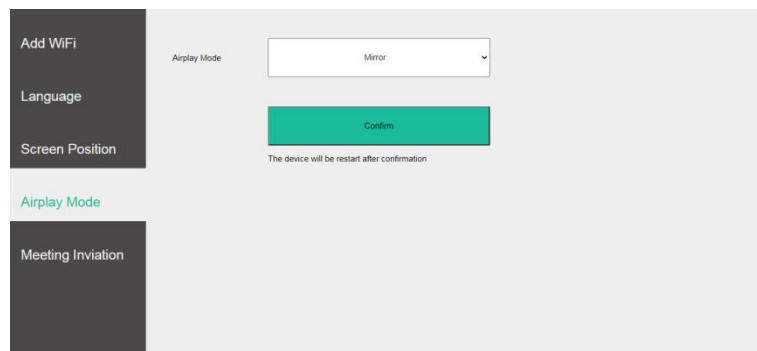

" Mirror" means to cast the current image of the phone, while "streaming" means that when using iQIYI, Tencent and other video software to play a video, it will acquire the video address for playing.

Please check the technical support on Apple's official website for the specific AirPlay "Streaming" and "Mirror" operation: <https://support.apple.com/zh-cn/HT204289>

3.1.5 Meeting Invitation

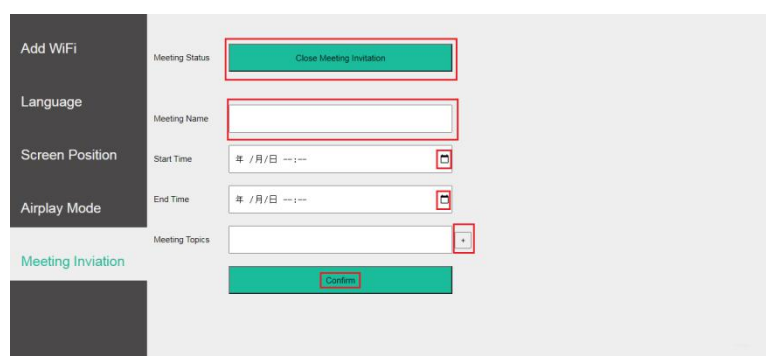

Click "Meeting Invitation", open Meeting Invitation in Meeting Status, and fill in the Meeting Name, Start Time, End Time and Meeting Topics (up to eight topics), then click Confirm, the information will show on the top right corner of the screen.

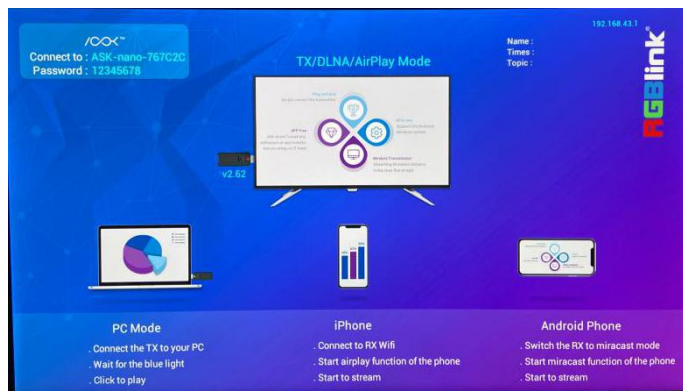

3.2 Computer Screen Projection by TX

Connect TX's HDMI port to Windows or macOS computer's HDMI port. If it can not be projected, then power on TX, and the indicator light turns from red to flashing blue. Touch the projection key lightly, the screen of the computer will be projected to the big screen of RX. Press the key again, the screen projection will exit.

3.3 Phone Screen Projection

3.3.1 Apple

Select two modes of iPhone projection: "Mirror" and "Streaming" which can be done on the web menu, as mentioned in 3.1.5 AirPlay screen selection. Both modes should connect the RX's hotspot in TX/DLNA/AirPlay Mode.

1. Search RX's own hotspot in Settings. The WIFI name is usually ASK Nano-XXXXXX, and the initial password is 12345678 or check the password displayed on the standby interface of RX.
2. Click "Screen Mirroring" in general Settings to project the image of phone to the big screen.

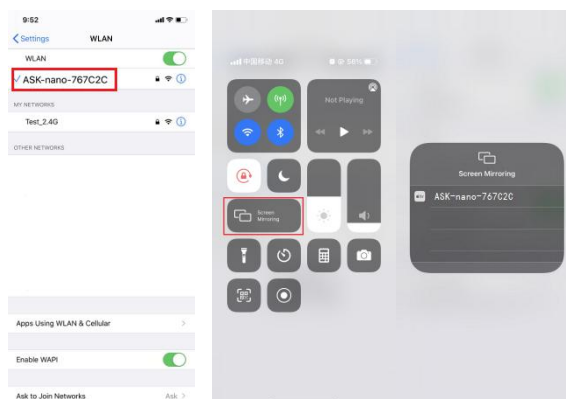

3.3.2 Android

Android phones have two projection modes, Miracast Mode and TX/DLNA/AirPlay Mode. The way to switch between the two modes is to lightly touch the mode switch key on the RX. In TX/DLNA/AirPlay Mode, an Android phone can only project pictures and videos, and in Miracast mode, an Android phone can project the current image of the mobile phone.

Note: Users can select the wiring in the right picture to connect your phone and TX by themselves. If using the wiring, Android phone can project the current image of the phone without switching mode.



TX/DLNA/AirPlay Mode

In this mode, the screen projection method of Android phones is the same as that of iPhone phones, both of which need to be connected to the hotspot of RX. The specific steps are as follows:

1. Search RX's own hotspot in Settings. The WIFI name is usually ASK Nano-XXXXXX, and the initial password is 12345678 or check the password displayed on the standby interface of RX.
2. Click "Wireless Projection" in general Settings to project the current image to the big screen.

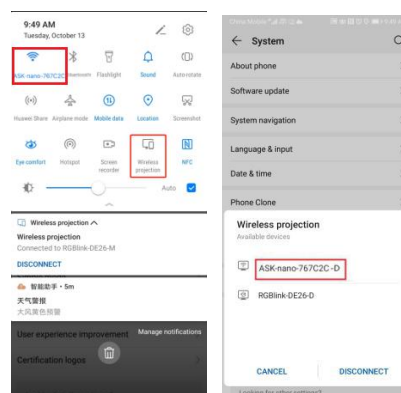

Miracast Mode

The screen projection steps of Android phones in Miracast Mode are as follows:

1. Touch the Mode Switch Key on the RX to enter Miracast Mode. The screen on the RX will show "Miracast Mode".
2. Open "Wireless Projection" in the general list, and select ASK nano from the list.



Note: When clicking "Wireless Projection", select "Yes" on WLAN setting, and the mobile phone does not need to be connected to any LAN WIFI.

3.4 Single Screen Mode

In TX/DLNA/AirPlay Mode:

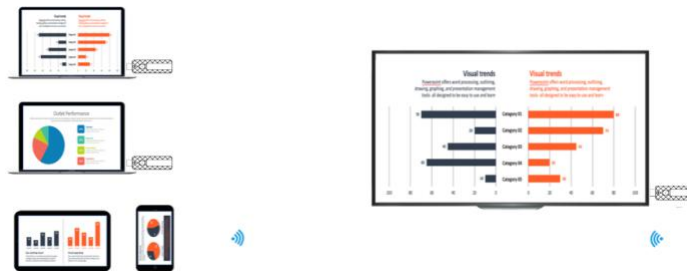

If there is only one TX, gently touch the projection key and the image of the computer can be projected to the big screen.

If there is more than one TX, gently touch the second TX's projection key, the image of the second laptop will automatically replace the image of the first TX.

If you use iPhone or iPad, clicking "Screen Mirroring" after connecting to RX's hotspot, the image of iPhone or iPad will be cast to the big screen after previous TX exits projection.

If you use Android phone, clicking "Wireless Projection" after connecting to RX's hotspot, the image of mobile phone will be cast to the big screen after previous TX exits projection.

Note: TX screen projection takes precedence over mobile hotspot screen projection. TX must exit the screen projection before the mobile phone can cast the screen. Unsuccessful mobile phone wireless projection means that the device name of RX cannot be found in the Screen Mirror list and Wireless Projection list.

3.5 Examples Demonstration of Screen Projection

When using Windows computer, macOS computer, Android phone and iPhone simultaneously in TX/DLNA/AirPlay Mode:

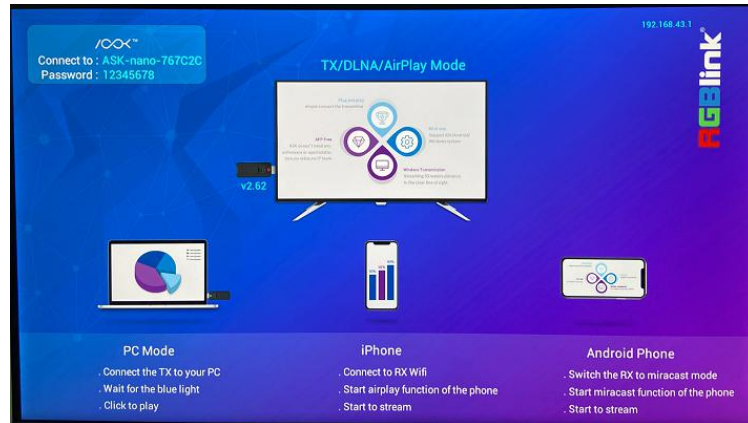

1) When using Windows computer to project, plug TX firstly, and gently touch the projection key, then the image of computer can be cast to the big screen;

2) When using MAC computer, plug TX firstly, and gently touch the projection key, then the image of MAC computer will replace that of Windows computer, as shown in the picture;

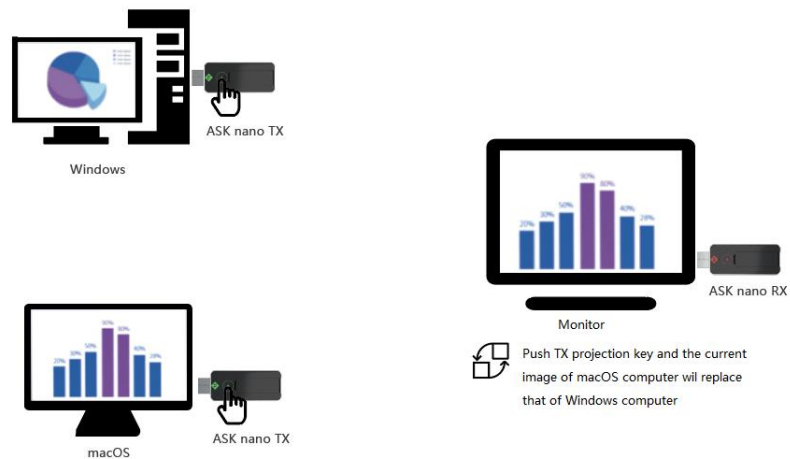

Note:When Android and iPhone connect to the RX's hotspot, the RX can only be found in the screen projection list after Windows and MAC computer exit TX projection first. The way to exit TX projection is to touch the projection key on TX again. If the screen enters the standby interface, TX exits successfully. If not, touch the key again;

3) Clicking "Wireless Projection" on Android phone, the pictures and videos will be cast to the big screen;

4) Clicking “Screen Mirroring” on iPhone,the image will be cast to the big screen;

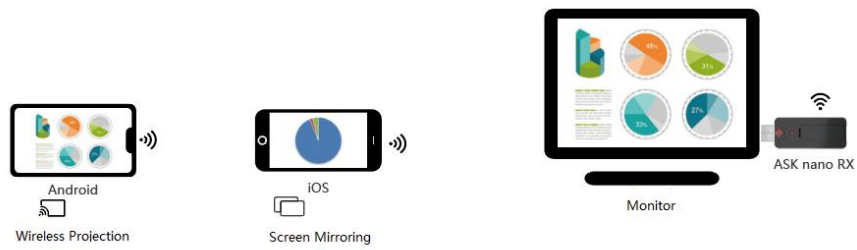

5) When using Windows computer to cast again,touch the projection key on the TX again,the image of computer will be cast to the big screen.

Chapter 4 Order Codes

Product Code	Item
450-0101-02-0	ASK nano TX
450-0002-02-0	ASK nano RX
450-1002-01-0	ASK nano Starter Set (TX*1+RX*1)
450-1004-01-0	ASK nano Meet Set (TX*2+RX*1)

Chapter 5 Support

5.1 Contact Us

www.rgblink.com



Inquiries

+86-592-577-1197
info@rgblink.com
rgblink.com/contact-us

Global Support

support@rgblink.com
rgblink.com/support-me



@RGLINK



/rgblink



+rgblink



/rgblink



rgblink



rgblink

RGBlink Headquarters

Xiamen, China

6th Floor Weiye Building
Torch Park Hi Tech Zone
Huli

sales@rgblink.com

+86-592-577-1197

China Regional Sales & Support

Shenzhen, China

11th Floor Baiwang Building
5318 Shahe West Road
Baimang, Nanshan

+86-755-2153-5149

Beijing Region Office

Beijing, China

Building 8, 25 Qixiao Road
Shahe Town Changping

+86- 4008-592-114

Europe Regional Sales & Support

Eindhoven, Holland

Flight Forum Eindhoven
5657 DW

eu@rgblink.com

+31(040)-202-71-83

India Regional Sales & Support

Mumbai, India

78/626, Motilal Nagar, No1,
Rd No1, Goregaon West,
Mumbai

support@rgblink.com

+91-98200-86718

Chapter 6 Appendix

1.1 Specification

Receiver

Connectors	Output	HDMI	1×HDMI-A	
	Power	USB	1×microUSB	
Performance	Output Resolutions	HDMI		
		SMPTE	1080p@60	
	Supported Standard	HDMI	1.3	
Power	Input Voltage	DC 5V/0.5A		
	Max Power	2.5W		
Environment	Temperature	0°C~70°C		
	Humidity	10%~85%		
Physical	Weight	Net	0.03kg	
		Packaged	0.34kg	
	Dimension	Net	85mm×30mm×13mm	
		Packaged	170mm×120mm×50mm	

Transmitter

Connectors	Output	HDMI	1×HDMI-A	
	Power	USB	1×microUSB	
Performance	Input Resolutions	HDMI		
		VESA	800×600@60 1024×768@60 1280×720@60 1280×800@60 1280×960@60 1280×1024@60 1400×1050@60 1600×1200@60 1920×1080@60	
	Supported Standard	HDMI	1.3	
Power	Input Voltage	DC 5V/0.5A		
	Max Power	2.5W		
Environment	Temperature	0°C~70°C		
	Humidity	10%~85%		
Physical	Weight	Net	0.03kg	
		Packaged	0.34kg	
	Dimension	Net	85mm×30mm×13mm	
		Packaged	170mm×120mm×50mm	

6.2 Terms & Definitions

●**RCA**: Connector used primarily in consumer AV equipment for both audio and video. The RCA connector was developed by the Radio Corporation of America.

●**BNC**: Stands for Bayonet Neill-Concelman. A cable connector used extensively in television (named for its inventors). A cylindrical bayonet connector that operates with a twist-locking motion .

●**CVBS**: CVBS or Composite video, is an analog video signal without audio. Most commonly CVBS is used for transmission of standard definition signals. In consumer applications the connector is typically RCA type, while in professional applications the connector is BNC type.

●**YPbPr**: Used to describe the colour space for progressive-scan. Otherwise known as component video.

● **VGA:** Video Graphics Array. VGA is an analog signal typically used on earlier computers. The signal is non-interlaced in modes 1, 2, and 3 and interlaced when using in mode

● **DVI:** Digital Visual Interface. The digital video connectivity standard that was developed by DDWG (Digital Display Work Group). This connection standard offers two different connectors: one with 24 pins that handles digital video signals only, and one with 29 pins that handles both digital and analog video.

● **SDI:** Serial Digital Interface. Standard definition video is carried on this 270 Mbps data transfer rate. Video pixels are characterized with a 10-bit depth and 4:2:2 color quantization. Ancillary data is included on this interface and typically includes audio or other metadata. Up to sixteen audio channels can be transmitted. Audio is organised into blocks of 4 stereo pairs. Connector is BNC.

● **HD-SDI:** high-definition serial digital interface (HD-SDI), is standardized in SMPTE 292M this provides a nominal data rate of 1.485 Gbit/s.

● **3G-SDI:** standardized in SMPTE 424M, consists of a single 2.970 Gbit/s serial link that allows replacing dual link HD-SDI.

● **6G-SDI:** standardized in SMPTE ST-2081 released in 2015, 6Gbit/s bitrate and able to support 2160p@30.

● **12G-SDI:** standardized in SMPTE ST-2082 released in 2015, 12Gbit/s bitrate and able to support 2160p@60.

● **U-SDI:** Technology for transmitting large-volume 8K signals over a single cable. a signal interface called the ultra high definition signal/data interface (U-SDI) for transmitting 4K and 8K signals using a single optical cable. The interface was standardized as the SMPTE ST 2036-4.

● **HDMI:** High Definition Multimedia Interface: An interface used for the transmission of uncompressed high definition video, up to 8 channels of audio, and control signals, over a single cable.

● **HDMI 1.3:** released on June 22 2006, and increased the maximum TMDS clock to 340 MHz (10.2 Gbit/s). Support resolution 1920 × 1080 at 120 Hz or 2560 × 1440 at 60 Hz). It added support for 10 bpc, 12 bpc, and 16 bpc color depth (30, 36, and 48 bit/px), called deep color.











● **HDMI 1.4:** released on June 5, 2009, added support for 4096 × 2160 at 24 Hz, 3840 × 2160 at 24, 25, and 30 Hz, and 1920 × 1080 at 120 Hz. Compared to HDMI 1.3, 3 more features added which are HDMI Ethernet Channel (HEC), audio return channel (ARC), 3D Over HDMI, a new Micro HDMI Connector, an expanded set of color spaces.

● **HDMI 2.0,** released on September 4, 2013 increases the maximum bandwidth to 18.0 Gbit/s. Other features of HDMI 2.0 include up to 32 audio channels, up to 1536 kHz audio sample frequency, the HE-AAC and DRA audio standards, improved 3D capability, and additional CEC functions.

-
- **HDMI 2.0a:** was released on April 8, 2015, and added support for High Dynamic Range (HDR) video with static metadata.
 - **HDMI 2.0b:** was released March, 2016, support for HDR Video transport and extends the static metadata signaling to include Hybrid Log-Gamma (HLG).
 - **HDMI 2.1 :** released on November 28, 2017. It adds support for higher resolutions and higher refresh rates, Dynamic HDR including 4K 120 Hz and 8K 120 Hz.
 - **DisplayPort:** A VESA standard interface primarily for video, but also for audio, USB and other data. DisplayPort (orDP) is backwards compatible with HDMI, DVI and VGA.
 - **DP 1.1:** was ratified on 2 April 2007, and version 1.1a was ratified on 11 January 2008. DisplayPort 1.1 allow a maximum bandwidth of 10.8 Gbit/s (8.64 Gbit/s data rate) over a standard 4-lane main link, enough to support 1920x1080@60Hz
 - **DP 1.2:** introduced on 7 January 2010, effective bandwidth to 17.28 Gbit/s support increased resolutions, higher refresh rates, and greater color depth, maximum resolution 3840 × 2160@60Hz
 - **DP 1.4:** publish on 1 Mar, 2016. overall transmission bandwidth 32.4 Gbit/s ,DisplayPort 1.4 adds support for Display Stream Compression 1.2 (DSC), DSC is a "visually lossless" encoding technique with up to a 3:1 compression ratio. Using DSC with HBR3 transmission rates, DisplayPort 1.4 can support 8K UHD (7680 × 4320) at 60 Hz or 4K UHD (3840 × 2160) at 120 Hz with 30 bit/px RGB color and HDR. 4K at 60 Hz 30 bit/px RGB/HDR can be achieved without the need for DSC.
 - **Multi-mode Fiber:** Fibers that support many propagation paths or transverse modes are called multi-mode fibers, generally have a wider core diameter and are used for short-distance communication links and for applications where high power must be transmitted.
 - **Single-mode Fiber:** Fiber that support a single mode are called single-mode fibers. Single-mode fibers are used for most communication links longer than 1,000 meters (3,300 ft).
 - **SFP:** small form-factor pluggable , is a compact, hot-pluggable network interface module used for both telecommunication and data communications applications.
 - **optical fiber connector:** terminates the end of an optical fiber, and enables quicker connection and disconnection than splicing. The connectors mechanically couple and align the cores of fibers so light can pass. 4 most common types of optical fiber connectors are SC, FC, LC,ST.
 - **SC:**(Subscriber Connector), also known as the square connector was also created by the Japanese company – Nippon Telegraph and Telephone. SC is a push-pull coupling type of connector and has a 2.5mm diameter. Nowadays, it is used mostly in single mode fiber optic patch cords, analog, GBIC, and CATV. SC is one of the most popular options, as its simplicity in design comes along with great durability and affordable prices.

- **LC:** (Lucent Connector) is a small factor connector (uses only a 1.25mm ferrule diameter) that has a snap coupling mechanism. Because of its small dimensions, it is the perfect fit for high-density connections, XFP, SFP, and SFP+ transceivers.
- **FC :**(Ferrule Connector) is a screw type connector with a 2.5mm ferrule. FC is a round shaped threaded fiber optic connector,mostly used on Datacom, telecom, measurement equipment, single-mode laser.
- **ST:** (Straight Tip) was invented by AT&T and uses a bayonet mount along with a long spring-loaded ferrule to support the fiber.
- **USB:** Universal Serial Bus is a standard that was developed in the mid-1990s that defines cables, connectors and communication protocols. This technology is designed to allow a connection, communication and power supply for peripheral devices and computers.
- **USB 1.1:** Full-Bandwidth USB, specification was the first release to be widely adopted by the consumer market. This specification allowed for a maximum bandwidth of 12Mbps.
- **USB 2.0:** or Hi-Speed USB, specification made many improvements over USB 1.1. The main improvement was an increase in bandwidth to a maximum of 480Mbps.
- **USB 3.2:** Super Speed USB with 3 varieties of 3.2 Gen 1(original name USB 3.0), 3.2Gen 2(original name USB 3.1), 3.2 Gen 2x2 (original name USB 3.2) with speed up to 5Gbps,10Gbps,20Gbps respectively.

USB version and connectors figure:

	Type A	Type B	Mini A	Mini B	Micro-A	Micro-B	Type C
USB 2.0							
USB 3.0							
USB 3.1&3.2							

- **NTSC :** The colour video standard used in North America and some other parts of the world created by the National Television Standards Committee in the 1950s. NTSC utilizes an interlaced video signals.
- **PAL:** Phase Alternate Line. A television standard in which the phase of the colour carrier is alternated from line to line. It takes four full images (8 fields) for the colour-to-horizontal images (8 fields) for the colour-to-horizontal phase relationship to return to the reference point. This alternation helps cancel

out phase errors. For this reason, the hue control is not needed on a PAL TV set. PAL, is widely used in needed on a PAL TV set. PAL, is widely used in Western Europe, Australia, Africa, the Middle East, and Micronesia. PAL uses 625-line, 50-field (25 fps) composite colour transmission system.

- **SMPTE:** Society of Motion image and Television Engineers. A global organization, based in the United States, that sets standards for baseband visual communications. This includes film as well as video and television standards.
- **VESA:** Video Electronics Standards Association. An organization facilitating computer graphics through standards.
- **HDCP:** High-bandwidth Digital Content Protection (HDCP) was developed by Intel Corporation and is in wide use for protection of video during transmission between devices.
- **HDBaseT:** A video standard for the transmission of uncompressed video (HDMI signals) and related features using Cat 5e/Cat6 cabling infrastructure.
- **ST2110:** A SMPTE developed standard, ST2110 describes how to send digital video over and IP networks. Video is transmitted uncompressed with audio and other data in a separate streams. SMPTE2110 is intended principally for broadcast production and distribution facilities where quality and flexibility are more important.
- **SDVoE:** Software Defined Video over Ethernet (SDVoE) is a method for transmission, distribution and management AV signals using a TCP/IP Ethernet infrastructure for transport with low latency. SDVoE is commonly used in integration applications.
- **Dante AV:** The Dante protocol was developed for and widely adopted in audio systems for the transmission of uncompressed digital audio on IP based networks. The more recent Dante AV specification includes support for digital video.
- **NDI:** Network Device interface (NDI) is a software standard developed by NewTek to enable video-compatible products to communicate, deliver, and receive broadcast quality video in a high quality, low latency manner that is frame-accurate and suitable for switching in a live production environment over TCP (UDP) Ethernet based networks. NDI is commonly found in broadcast applications.
- **RTMP:** Real-Time Messaging Protocol (RTMP) was initially a proprietary protocol developed by Macromedia (now Adobe) for streaming audio, video and data over the Internet, between a Flash player and a server.
- **RTSP :** The Real Time Streaming Protocol (RTSP) is a network control protocol designed for use in entertainment and communications systems to control streaming media servers. The protocol is used for establishing and controlling media sessions between end points.
- **MPEG:** Moving Picture Experts Group is a working group formed from ISO and IEC developing standards that allow audio/video digital compression and Transmission.

●**H.264:** Also known as AVC (Advanced Video Coding) or MPEG-4i is a common video compression standard. H.264 was standardized by the ITU-T Video Coding Experts Group (VCEG) together with the ISO/IEC JTC1 Moving Picture Experts Group (MPEG).

●**H.265:** Also known as **HEVC** (High Efficiency Video Coding) H.265 is the successor to the widely used H.264/AVC digital video coding standard. Developed under the auspices of ITU, resolutions up to 8192x4320 may be compressed.

●**API:** An Application Programming Interface (API) provides a predefined function which allows access capabilities and features or routines via a software or hardware, without accessing source code or understanding the details of inner working mechanism. An API call may execute a function and/or provide data feedback/report.

●**DMX512:** The communication standard developed by USITT for entertainment and digital lighting systems. The wide adoption of the Digital Multiplex (DMX) protocol has seen the protocol used for a wide range of other devices including video controllers. DMX512 is delivered over cable of 2 twisted pairs with 5pin XLR cables for connection.

●**ArtNet:** An ethernet protocol based on TCP/IP protocol stack, mainly used in entertainment/events applications. Built on the DMX512 data format, ArtNet enables multiple “universes” of DMX512 to be transmitted using ethernet networks for transport.

●**MIDI:** MIDI is the abbreviation of Musical Instrument Digital Interface. As the name indicates the protocol was developed for communication between electronic musical instruments and latterly computers. MIDI instructions are triggers or commands sent over twisted pair cables, typically using 5pin DIN connectors.

●**OSC:** The principle of Open Sound Control (OSC) protocol is for networking sound synthesizers, computers, and multimedia devices for musical performance or show control. As with XML and JSON, the OSC protocol allows sharing data. OSC is transported via UDP packets between devices connected on an Ethernet.

●**Brightness:** Usually refers to the amount or intensity of video light produced on a screen without regard to colour. Sometimes called black level.

●**Contrast Ratio:** The ratio of the high light output level divided by the low light output level. In theory, the contrast ratio of the television system should be at least 100:1, if not 300:1. In reality, there are several limitations. Well-controlled viewing conditions should yield a practical contrast ratio of 30:1 to 50:1.

● **Colour Temperature:** The colour quality, expressed in degrees Kelvin (K), of a light source. The higher the colour temperature, the bluer the light. The lower the temperature, the redder the light. Benchmark colour temperature for the A/V industry include 5000°K, 6500°K, and 9000°K.

● **Saturation:** Chroma, Chroma gain. The intensity of the colour, or the extent to which a given colour in any image is free from white. The less white in a colour, the truer the colour or the greater its saturation. Saturation is the amount of pigment in a colour, and not the intensity.

● **Gamma:** The light output of a CRT is not linear with respect to the voltage input. The difference between what you should have and what is actually output is known as gamma.

● **Frame:** In interlaced video, a frame is one complete image. A video frame is made up of two fields, or two sets of interlaced lines. In a film, a frame is one still image of a series that makes up a motion image.

● **Genlock:** Allows synchronisation of otherwise video devices. A signal generator provides a signal pulses which connected devices can reference. Also see Black Burst and Color Burst.

● **Blackburst:** The video waveform without the video elements. It includes the vertical sync, horizontal sync, and the Chroma burst information. Blackburst is used to synchronize video equipment to align the video output.

● **Colour Burst:** In colour TV systems, a burst of subcarrier frequency located on the back part of the composite video signal. This serves as a colour synchronizing signal to establish a frequency and phase reference for the Chroma signal. Colour burst is 3.58 MHz for NTSC and 4.43 MHz for PAL.

● **Colour Bars:** A standard test pattern of several basic colours (white, yellow, cyan, green, magenta, red, blue, and black) as a reference for system alignment and testing. In NTSC video, the most commonly used colour bars are the SMPTE standard colour bars. In PAL video, the most commonly used colour bars are eight full field bars. On computer monitors the most commonly used colour bars are two rows of reversed colour bars

● **Seamless Switching:** A feature found on many video switchers. This feature causes the switcher to wait until the vertical interval to switch. This avoids a glitch (temporary scrambling) which often is seen when switching between sources.

● **Scaling:** A conversion of a video or computer graphic signal from a starting resolution to a new resolution. Scaling from one resolution to another is typically done to optimize the signal for input to an image processor, transmission path or to improve its quality when presented on a particular display.

● **PIP:** Picture-In-Picture. A small image within a larger image created by scaling down one of image to make it smaller. Other forms of PIP displays include Picture-By-Picture (PBP) and Picture- With-Picture (PWP), which are commonly used with 16:9 aspect display devices. PBP and PWP image formats require a separate scaler for each video window.

●**HDR:** is a high dynamic range (HDR) technique used in imaging and photography to reproduce a greater dynamic range of luminosity than what is possible with standard digital imaging or photographic techniques. The aim is to present a similar range of luminance to that experienced through the human visual system.

●**UHD:** Standing for Ultra High Definition and comprising 4K and 8K television standards with a 16:9 ratio, UHD follows the 2K HDTV standard. A UHD 4K display has a physical resolution of 3840x2160 which is four times the area and twice both the width and height of a HDTV/FullHD (1920x1080) video signal.

●**EDID:** Extended Display Identification Data. EDID is a data structure used to communicate video display information, including native resolution and vertical interval refresh rate requirements, to a source device. The source device will then output the provided EDID data, ensuring proper video image quality.

6.3 Revision History

The table below lists the changes of ASK nano User Manual.

Format	Time	ECO#	Description	Principal
V1.0	2020-12-07	0000#	Release	Sylvia
V1.1	2021-01-18	0001#	1. Modify RX and TX pairing method 2. Add Meeting Invitation 3. Add a cable to connect TX and Android phone.	Sylvia

All information herein is Xiamen RGBlink Science & Technology Co Ltd. excepting noted.

RGBlink[®] is a registered trademark of Xiamen RGBlink Science & Technology Co Ltd.

While all efforts are made for accuracy at time of printing, we reserve the right to alter otherwise make change without notice.