

iD44

AUDIO INTERFACE



User Manual V1.0

Thank you for purchasing this Audient product!

iD44 delivers the audio performance of a large format console in a compact and elegant desktop package.

iD44 provides four world-class Audient console mic pres, class leading converter technology, console style monitor control, JFET D.I and the revolutionary ScrollControl.

With its versatile feature set and intuitive layout, iD44 will become the hub of your studio in no time.

Features include:

- 4-in, 8-out high performance AD/DA converters
- 4 x Class-A Audient Console Mic Preamplifiers & 2 x discrete JFET instrument inputs.
- 2 x Independant Class-AB Headphones outputs
- Full Monitor Control Functionality (software controlled)
- iD Scroll Control Mode
- 2 x ADAT inputs and 2 x ADAT outputs for up to 16 channels of Digital I/O
- Word Clock output
- USB2.0 class compliant connectivity with integrated Low Latency DSP mixer



Box Contents	1
iD44 Overview	2
Safety Information	3
Declaration of Conformities	5
Installation:	6
Installation on Mac	6
Installation on Windows	8
iD App & Firmware Update	10
Hardware Features:	11
Microphone & Line Inputs	12
Instrument Inputs	13
Send and Returns	13
Digital Inputs and Outputs	14
Loudspeaker Outputs	19
Headphone Outputs	19
Monitor Control	21
Metering	23
Kensington Lock	23
Software Features	24
Input Channel Types	25
Channel Features	26
Master Section Features	28
System Panel Features	31
The Routing Matrix	33
Setting up Talkback	34
Saving/Loading presets	35
Menu/TaskBar Icons	36
Standalone Mode	37
Firmware Update	37
Keyboard Shortcuts	39

Daw Setup	28
Pro Tools Setup	41
Logic Pro X Setup	42
Cubase/Nuendo Setup	44
Ableton Live Setup	46
Troubleshooting & FAQ	47
Specifications	50
Dimensions	51
Warranty & Contact	52
Service	53
Glossary	54



In your iD44 packaging you should find the following items:

- iD44
- 12VDC PSU with regional adapters
- USB Type C Cable
- USB Type C to Type A Cable
- Quick Start Guide

Please visit:

www.audient.com/products/iD44 to download the latest iD software (mixer application and drivers), supporting documentation (including this manual) and brochures for our product range.

The 12VDC power supply comes with interchangeable UK, EU, US and Australian socket adapters and will work across a broad range of line voltages making iD44 globally portable.

We hope that you enjoy using iD44!

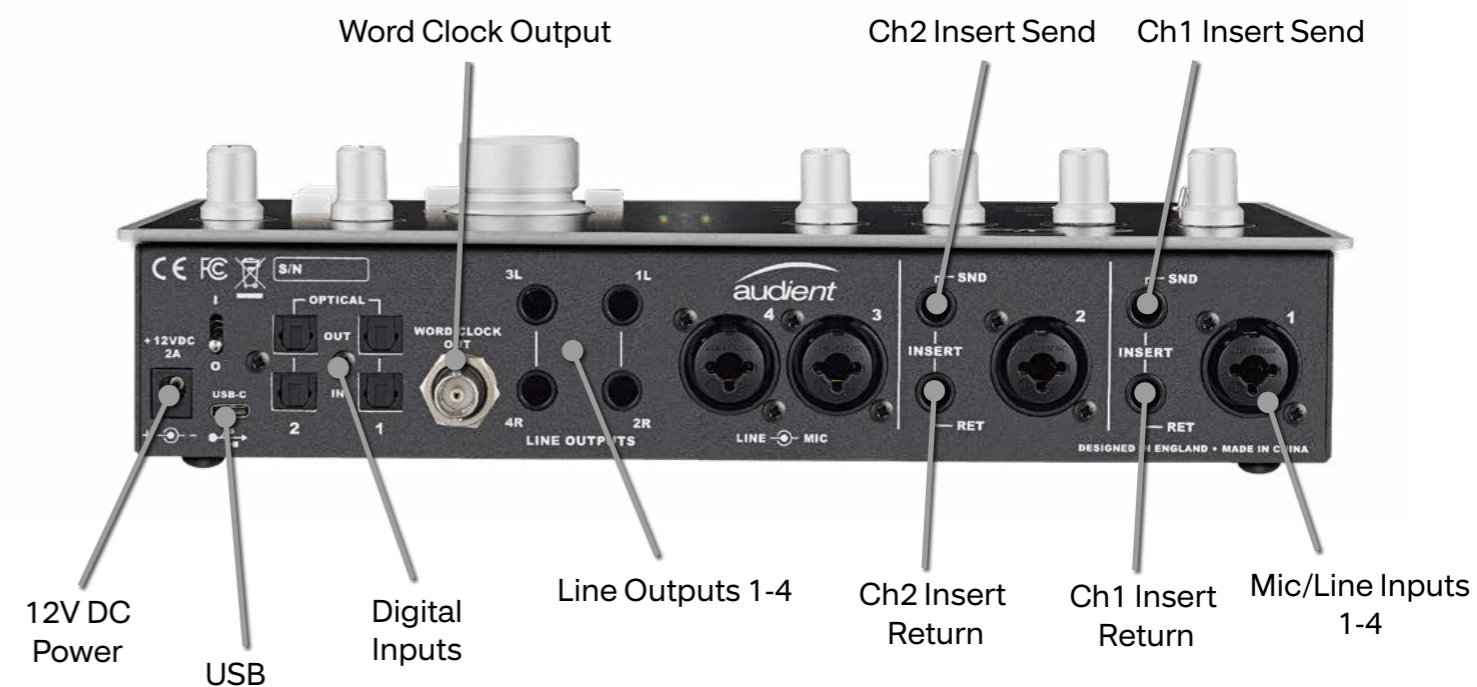
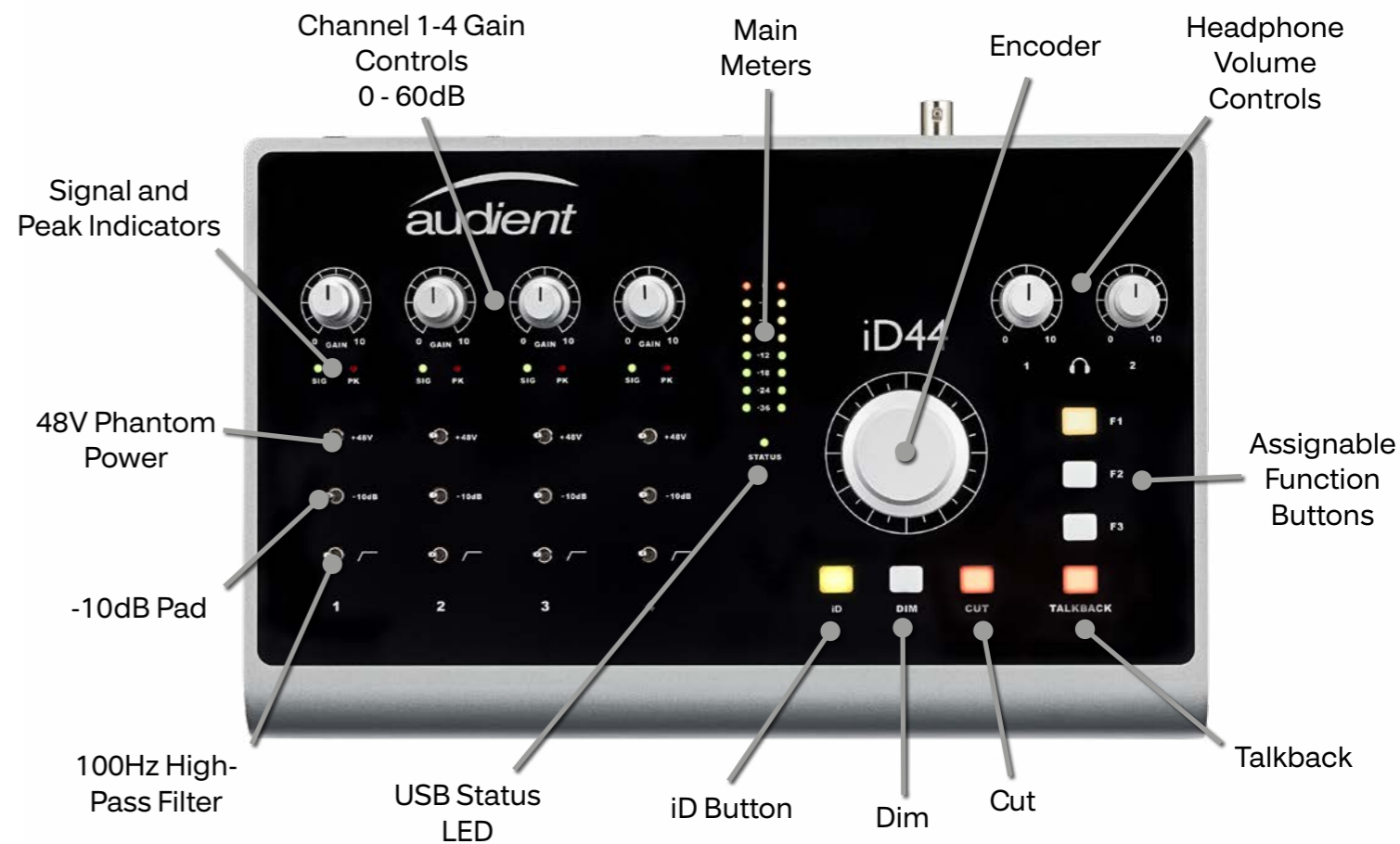

Important Safety Instructions

Please read all of these instructions and save them for later reference before connecting the DC power adapter to the mains and powering up iD44.

To prevent electrical shock and fire hazard follow all instructions on the 12VDC power supply. iD44 itself does not operate with any high voltage mains supply inside the unit but appropriate safety measures should still be adhered to regarding the AC/DC supply.

Please ensure you only use the supplied iD44 power supply. We cannot recommend the useage of third party power supplies. In the event of a power supply failure do not open the 12VDC supply. If required, please contact Audient support so that a suitable repacement can be sourced.

audient.com/support

iD44 utilises an external switch-mode power supply that is very quiet and rated at 2A. This switch-mode design will accept any A.C line voltage from 90v to 264v @ 47-63Hz. Therefore the unit will work anywhere in the world but please ensure your A.C mains line voltage is within this specification.

Consult a qualified technician if you suspect difficulties. Do not attempt to tamper with the power supply or mains voltages - HAZARDOUS TO HEALTH. Ensure that the appropriate international pin adapter is fitted to the power supply before insertion into the mains socket.

! WARNING !

TO REDUCE RISK OF FIRE OR ELECTRIC SHOCK, DO NOT EXPOSE THIS APPARATUS TO RAIN OR MOISTURE.

NO USER SERVICEABLE PARTS INSIDE.

PLEASE REFER SERVICING TO QUALIFIED SERVICE PERSONNEL.

Important Safety Instructions

1. Read these instructions
2. Keep these instructions
3. Heed all warnings
4. Follow all instructions
5. Do not use this equipment near water
6. Clean only with dry cloth
7. Do not install near any heat sources such as radiators, heat registers, stoves, or other equipment (including amplifiers) that produce heat
8. Do not defeat the safety purpose of the polarized or grounding-type plug. A polaized plug has two blades with one wider than the other. A grounding type plug has two blades and a third grounding prong. The wide blade or the third prong are provided for your safety. If the provided plug does not fit into your outlet, cosult an electrician for replacement of the obsolete outlet
9. Protect power cords from being walked on or pinched particularly at plugs, convenience receptacles, and the point where they exit from the equipment
Only use attachments/accessories specified by the manufacturer
10. Unplug this equipment during lightning storms or when unused for long periods of time
11. Refer all servicing to qualified service personnel. Servicing is required when the equipment has been damaged in any way, such as power supply cord or plug is damaged, liquid has been spilled or objects have fallen into the equipment, the equipment has been exposed to rain or moisture, does not operate normally, or has been dropped
12. For products that are a mains powered device: The equipment shall not be exposed to dripping or splashing and no objects filled with liquids (such as vases) shall be placed on the equipment.
13. Under the influence of electrostatic phenomenon, the product may malfunction and require the user to power cycle the unit.

FCC Part 15B

This apparatus has been tested and found to comply with the limits of a class-A digital device, pursuant to Part 15B of the FCC Rules. These limits are designed to provide reasonable protection against harmful interference in a residential installation. This equipment generates, uses and can radiate radio frequency energy and, if not installed and used in accordance with the instructions, may cause harmful interference to radio communications. If this equipment does cause harmful interference to radio or television reception, which can be determined by turning the equipment off and on, the user is encouraged to try to correct the interference by one or more of the following measures:

1. Re-orient or relocate the receiving antenna
2. Increase the separation between the equipment and receiver
3. Connect the equipment into an outlet on a different circuit from that to which the receiver is connected
4. Consult the dealer or an experienced radio/TV technician for help

We, Audient Ltd, Aspect House, Herriard, Hampshire, RG25 2PN, UK, 01256 381944, declare under our sole responsibility that the product iD44 complies with Part 15 of FCC Rules.

Operation is subject to the following two conditions:

1. This device may not cause harmful interference,
2. This device must accept any interference received, including interference that may cause undesired operation

We, Audient Ltd, declare that the product, the iD44, to which this declaration relates, is in material conformity with the appropriate CE standards and directives for an audio product designed for consumer use.

Audient Ltd has conformed where applicable, to the European Union's Directive 2002/95/EC on Restrictions of Hazardous Substances (RoHS) as well as the following sections of California law which refer to RoHS, namely sections 25214.10, 25214.10.2, and 58012, Health and Safety Code; Section 42475.2, Public Resources

System Requirements

- MacOS: 10.7.5 (Lion) or later
- Mac: Intel CPU, 1GB RAM Minimum

1. Download the Latest iD Software

Head to our website for the latest version of our iD Mixer:

audient.com/products/downloads/iD44



Open the downloaded .dmg file. Now, drag the downloaded app into your application folder to install it.

2. Connect iD44

Using the USB cable provided, connect iD44 to your computer's USB port.

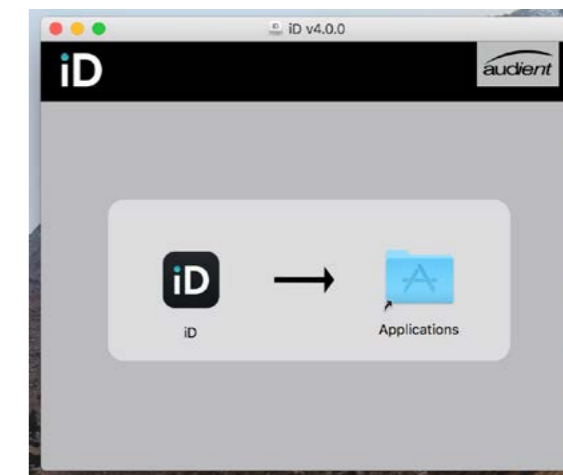



3. Status LED

Once connected to your computer and powered on, the green status LED on iD44 will illuminate.

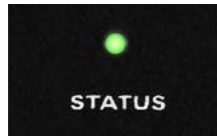

If at any time the status LED turns off during normal operation please check all connections and if further problems develop please contact Audient support.

4. Double Checking Connectivity

To ensure iD44 has been detected by your computer and correct clocking sources are set-up, navigate to:

Macintosh HD > Applications > System Preferences

Check that iD44 is set as your audio device. It's recommended to disable system sounds.

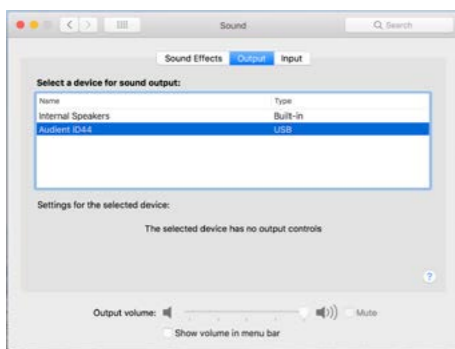

It's also worth checking Audio MIDI Setup (found in Mac HD > Applications > Utilities).

Window > Show Audio Window

Here you should see iD44 report with 20 inputs and 24 outputs. The clock source is configured in the iD app. See page 23 for more details.

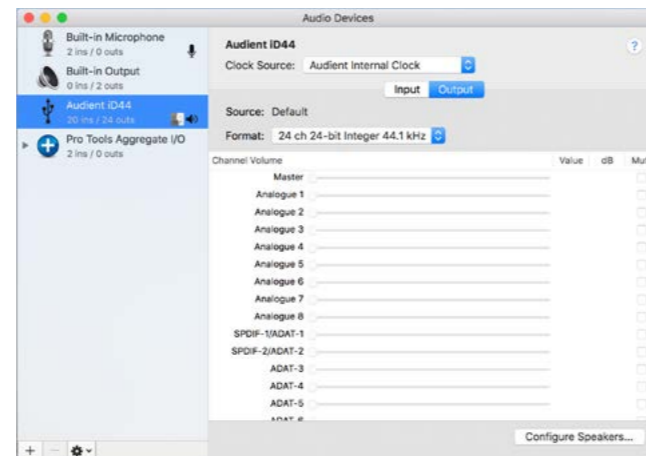

Menu/Task Bar Icons

On MacOS, the iD icon appears in the menu bar in the top right hand corner of the screen. This gives you quick access to various functions of the iD44.



Show Mixer

If the mixer window has been hidden, this will bring it back to the forefront.

Quit

Fully closes the iD mixer application.

About iD

Displays information regarding the current version of the iD mixer application.

Visit iD Knowledge Base

Opens a browser windows for the Audient Helpdesk with helpful articles and FAQ's.

Check for Updates

The iD app will check with the Audient update server for any available firmware updates for iD44.

Tip

Right click on the iD icon in the Dock and select Keep in Dock to have quick access to the iD mixer app at all times.

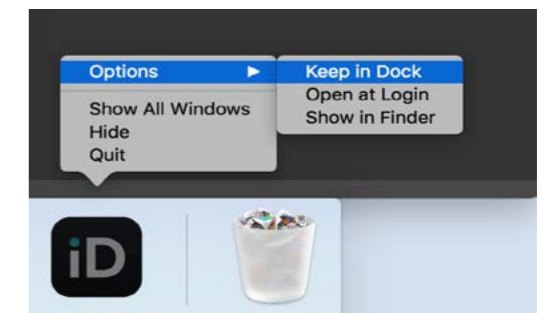

Windows System Requirements:

- Windows 7 or later (32 and 64 bit)
- Intel Core 2 @ 1.6 GHz, or AMD equivalent
- 1 GB RAM Minimum

1. Download the latest iD44 Software

Head to our website for the latest version of our iD Windows Installer:

audient.com/products/downloads/iD44

2. Connect iD44

Using the USB cable provided, connect iD44 to your computer's USB port and connect the iD44's power supply.

3. Run iD Mixer Setup

Double click on the installer to run the iD mixer setup and follow the on-screen instructions.

4. Reboot PC

Reboot your PC to make sure that the drivers have been installed.

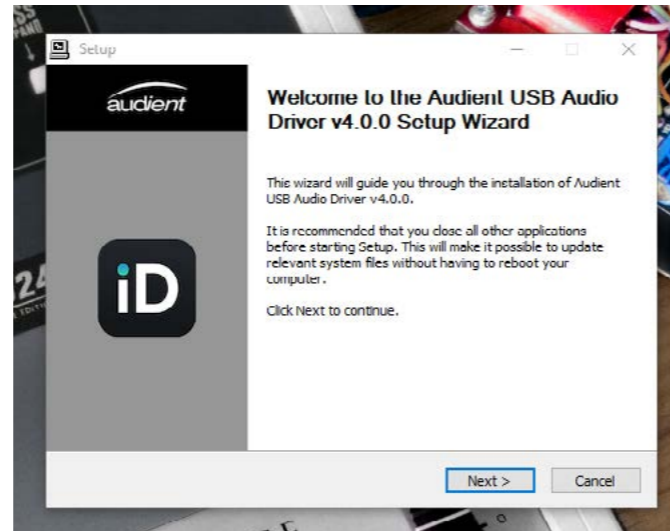
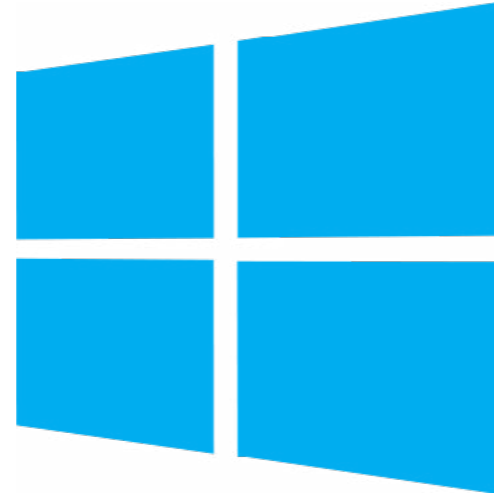

4. Check Connectivity



The status LED will become solidly lit as soon as iD44 has achieved stable communication and should remain solidly lit during operation of the unit until power down.

To double check the connection, go to PC sound settings by following:

PC Settings > Control Panel > Hardware and Sound > Sound

Here you can see whether iD44 is visible to the PC and you can make it the computers default sound device by pressing 'Set Default'.

iD Icon

Once installed, the iD icon can be found in the Windows system tray (it may be in the hidden icons area):

- Double-click to open iD44 mixer window when iD44 is connected
- Right-click to quit or change sample rate and buffer size.

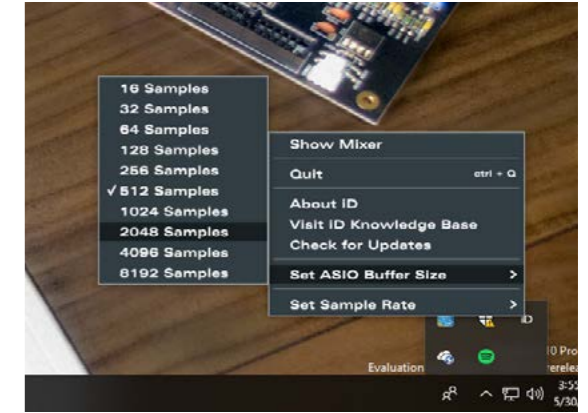

For mixing, a buffer size of 256 should be perfect. For tracking, experiment with lower buffer size values.

How powerful your computer is, and how processor hungry your project is, will affect how low you can get the buffer size settings before you get audio instability.

Launch the iD Mixer Application

Launch the iD mixer application by finding it in the following folder:

Macintosh HD > Applications > iD
Start > All Programs > Audient > iD



For more information on the mixer application feature set, please refer to page 17 of this manual onwards.



Check for Firmware Updates

If your computer is connected to the internet, the iD app will check for firmware updates whenever a unit is connected. If there is a firmware update available then the iD app will notify you.

You can manual check for updates by going to the Help menu and selecting 'Check for Updates'. It will notify you if you're on the latest version of firmware.

Firmware Update

When there is a firmware update, you can select 'From audient.com' to download the latest version automatically (or select 'From file' to install a local firmware file).

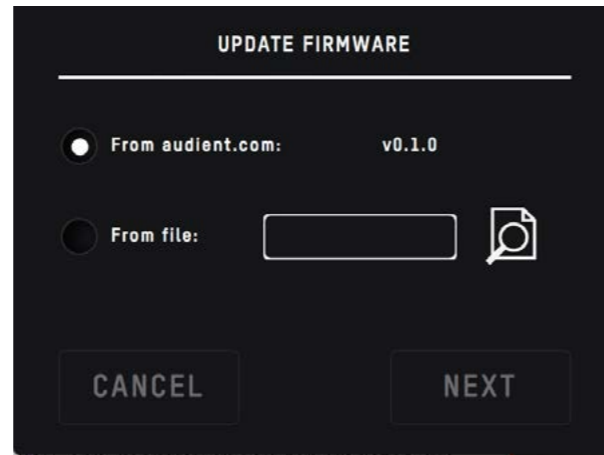

The latest version number will be retrieved from our servers and will be displayed (as shown above). Press next to continue with the firmware update. Press 'update' to install it. Once complete reboot iD44 using the power switch to apply it.

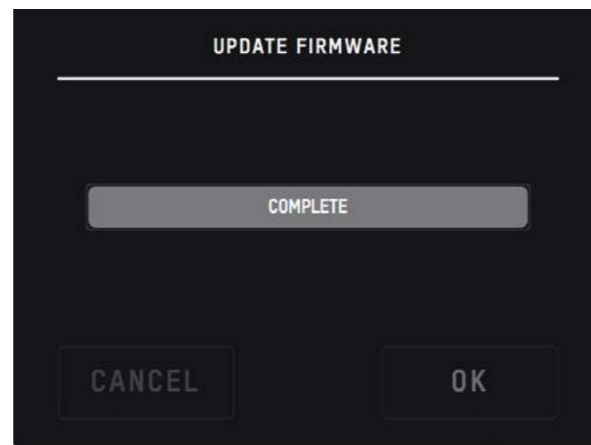

Hardware Features



Microphone Preamplifiers & Line Inputs

iD44 features four classic Audient microphone preamplifiers. These preamps are based on designs from Audient's classic consoles and are the same that are used across our entire product range.

The design features discrete Class-A circuitry providing exceedingly low distortion and noise performance. From a sonic point of view, iD44 is fast, open and detailed.

Neutrik™ XLR/TRS Jack combi-connectors provide microphone and line inputs. The line inputs are padded through the microphone preamplifiers.



The four microphone preamplifiers feature:

- 60 dB of clean gain
- 48V ($\pm 4V$) phantom power rated at 14mA/channel
- $>2.8k\Omega$ input impedance which provides a punchy tone from any microphone transducer type
- Signal and Clip Indicators
- -10dB Pad
- 100Hz High Pass Filter to remove unwanted rumble

Channels 1 and 2 also include an Insert Send and Return allowing for the use of outboard equipment while tracking.

Instrument Input

iD44 employs 2 discrete Class-A JFET instrument (D.I) inputs on channels one and two which are easily accessible on the front of the unit.

The JFET circuitry adds a tiny bit of colour and warmth to the signal, making it sound great on guitars and basses.

Plugging in a TS (tip-sleeve unbalanced) jack will override the mic signal for that channel and turn it into a fully fledged, fantastic sounding instrument input with access to the Pad and High Pass Filters.



Balanced Insert Send and Returns

On Channels 1 and 2, the iD44 features a dedicated insert to allow you to connect outboard gear to your recording chain; Just like the work flow you would find on an Audient console!

The two channels feature an impedance balanced send and an electronically balanced return, all before the AD convertors.

Insert your favourite EQ and compressor into the insert and with the super clean audient pre-amps, you can build vocal chains that will rival the best out there!

Insert Normalising

The Insert send and return jacks are half normalised meaning you don't need to patch the two together when not in use. The internal signal chain is only broken when a jack is plugged into the return. Plugging a jack into the Insert send will split the signal which can be useful for parallel processing.

Patching Inserts

To incorporate your favourite processing before conversion, simply patch the iD44 insert send into the first piece of gear in your processing chain. Then take the output of the last device in the chain and patch this into the iD44 insert return.

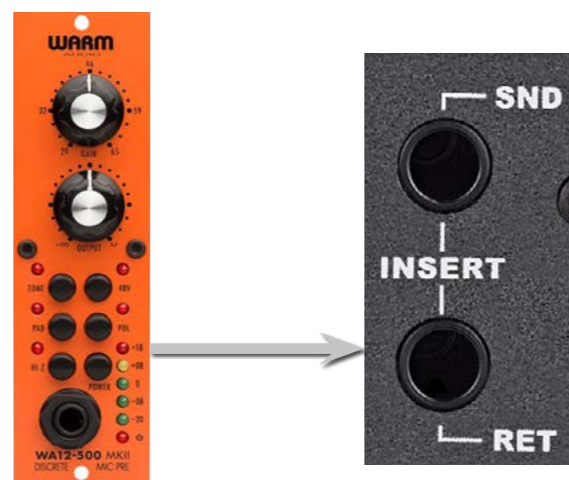

Direct Access to ADC

The Insert return connection on the iD44 is a electronically balanced input stage that directly drives the analog to digital convertor for that channel.

As such, this is a great place to input signals directly to the ADC, bypassing the pre-amplifiers and minimising any colouration of the signal.

This makes it useful to patch in external microphone pre-amplifiers without adding additional colouration or noise. It is also handy for using the iD44's outputs to drive external effects before returning them into your DAW using the insert returns.

Please note; the digital calibration level of the iD44's ADC is 0dBFS = +18dBu.

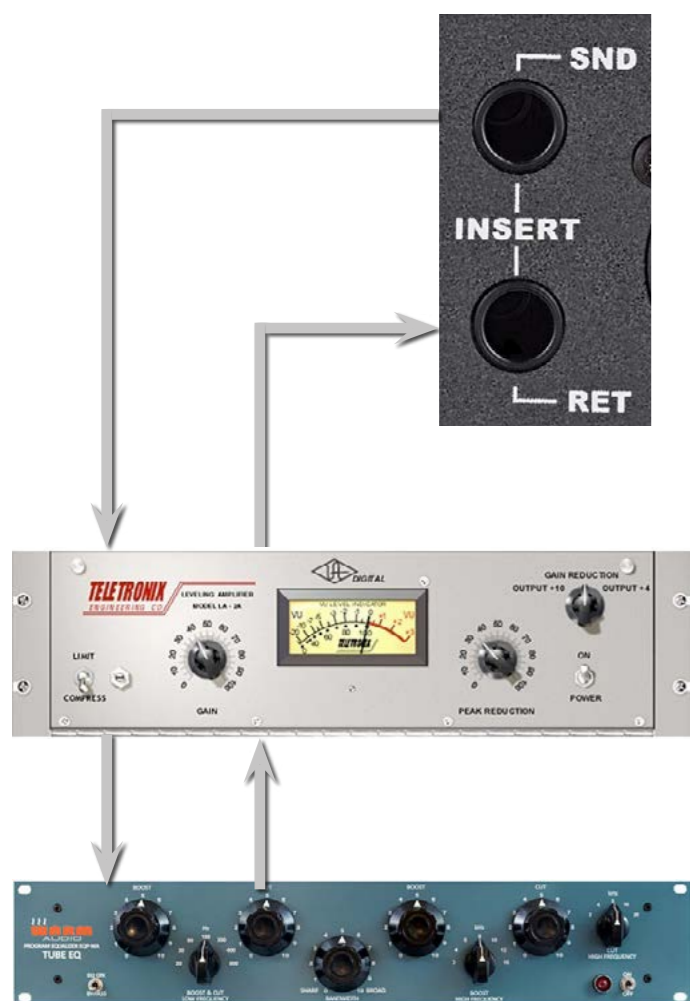

Digital Inputs and Outputs

iD44 features two optical inputs and two optical outputs. These can be set to operate using optical stereo S/PDIF or 8-channel ADAT using the iD mixer application. All i/o will operate at up to 96kHz, with ADAT dropping to 4 channels at sample rates of 88.2kHz or higher.



Running in S/PDIF mode, the optical i/o provides the option to integrate external digital outboard, allowing upto 4 channels of audio in and out of the iD44 at sample rates up to 96KHz.

Running in ADAT mode, the optical i/o provides a great way to expand to 20 inputs for recording via an external mic preamp such as the Audient ASP800.

The ADAT outputs could also be connected to headphone distribution systems such as a Hearback™ HUB or to an 8-channel DAC for summing purposes.

When using 88.2kHz and 96kHz as a sample rate, you only have access to 8 channels of digital input and 8 channels of digital output (due to the ADAT protocol).

Word Clock Output

The iD44 also includes a BNC Word Clock output which allows you clock multiple digital devices to the iD44's master clock and keep everything in sync.

The Word Clock output will send a clock signal at the same sample rate (44.1, 48, 88.2 or 96kHz) that the iD44 is operating at. This will occur regardless of whether the iD44 is being clocked internally or externally.



Clocking Configurations

When connecting external digital devices to the iD44, its important to ensure that all devices are synchronised.

To ensure this, one device in the setup must be set as the master clock. The other devices will then use the master clocks signal to stay in sync. There can only ever be one master clock present in a chain.

The master clock signal can be sent either via an Optical cable embedded into the digital signal data, or through a BNC clock line cable. Please bear in mind that the clock will only travel in one direction through these connections, from a devices output to a devices input.

Choosing a Master Clock

In a digital setup, there can be a number of options when determining which device should be your master clock. Quite often the best device to set as the master is the one that is connected to the computer (where possible) such as an audio interface. This way, when you open a project in a DAW, the audio interface should change to match the project sample rate, and therefore change the sample rate of all the slave devices. However this depends on the devices being used.

iD44 as the Master Clock

With the iD44 set as the Master Clock the other devices in the chain can be clocked by either the Optical Port or the BNC word clock output. When clocking just one device, clocking via the optical port would be the simplest option, simply connect the TOSlink cable up to the iD44's optical output and to the other digital devices input.

Then set the other device to Slave off the iD44's clock.

If you are using multiple devices then it is recommended to use the BNC word clock output and then use T-connectors to Daisy Chain the Devices together. It is important to note that the final device in the chain should have its BNC connector terminated with 75 Ohms to stop reflections of the clock signal. This should be a switchable option on most devices.



iD44 with Single BNC Connection

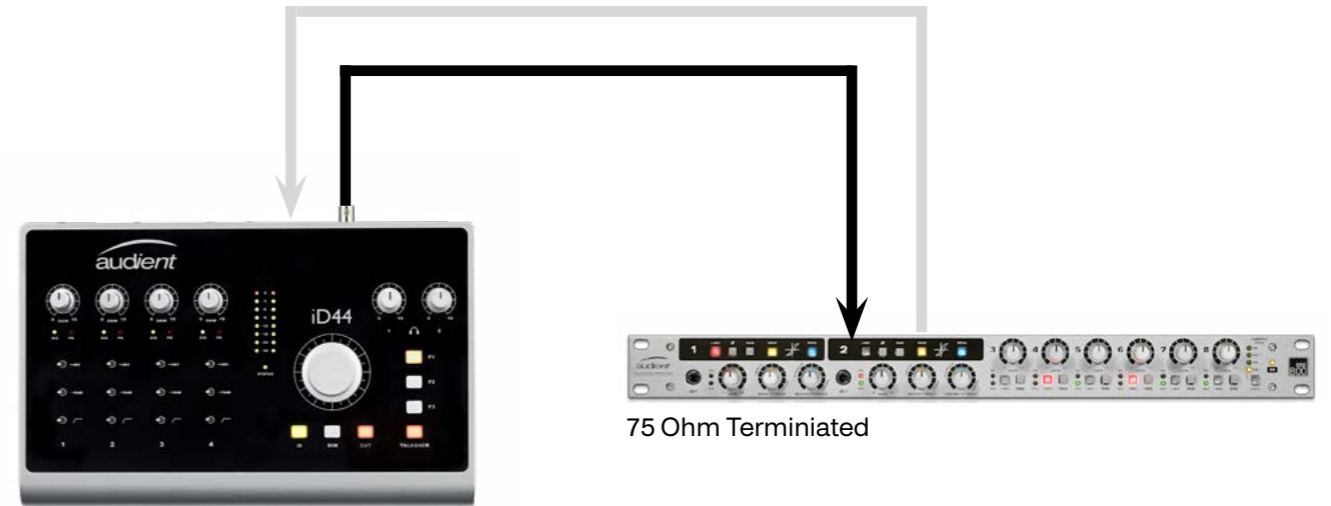

iD44 with Daisychained BNC connection

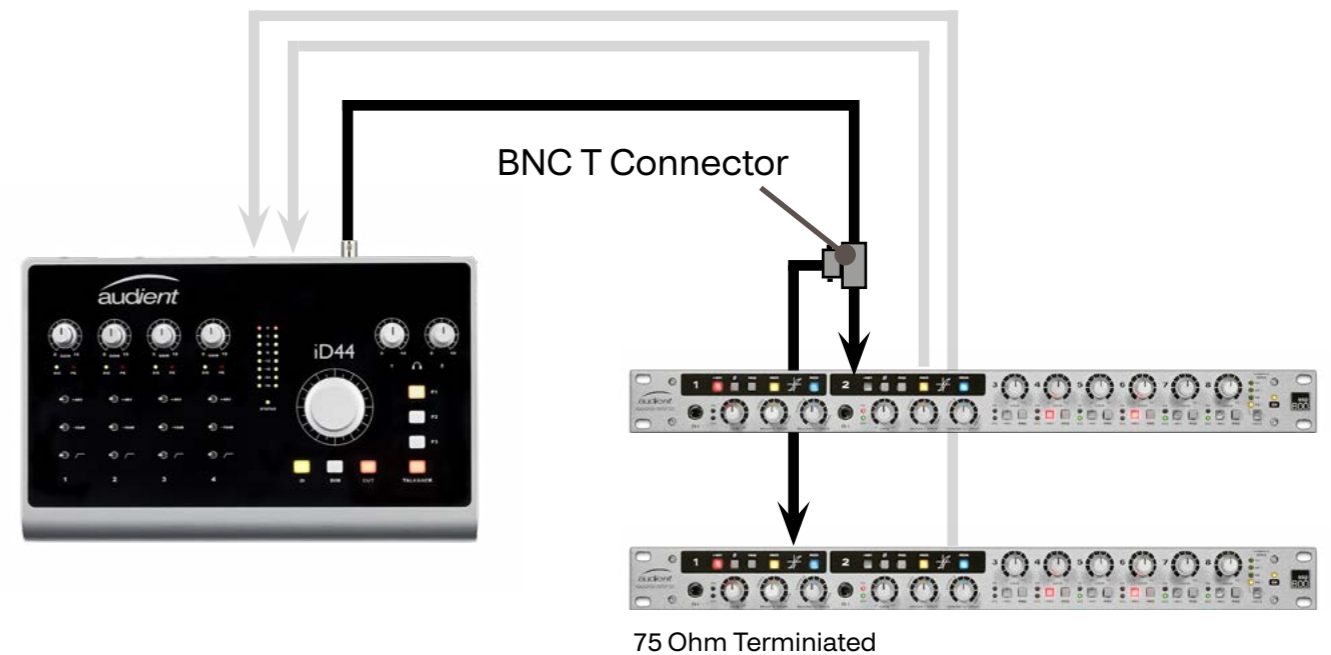

→ Optical TOSlink Cable

→ BNC Word Clock Cable

iD44 as the Slave

The iD44 can also act as the slave to an external master clock via it's optical inputs. The BNC connector is an output only.

In this case, you would simply connect the optical output of a device to the iD44's optical input. Then, in the iD mixer application, select the optical input you wish to be used as the clock source. You would also need to set the inputs to either ADAT or S/PDIF depending on the specification of the external device.

More advanced clocking setups for the iD44 can be found at audient.com/support/iD44.

iD44 clocked via the Optical Port

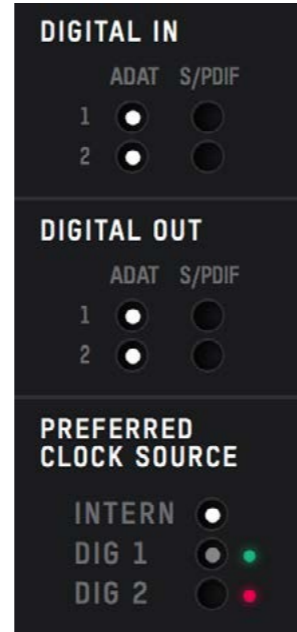

Class A Mic Preamplifier, Inserts, A/D converters and Optical Input Block Diagram

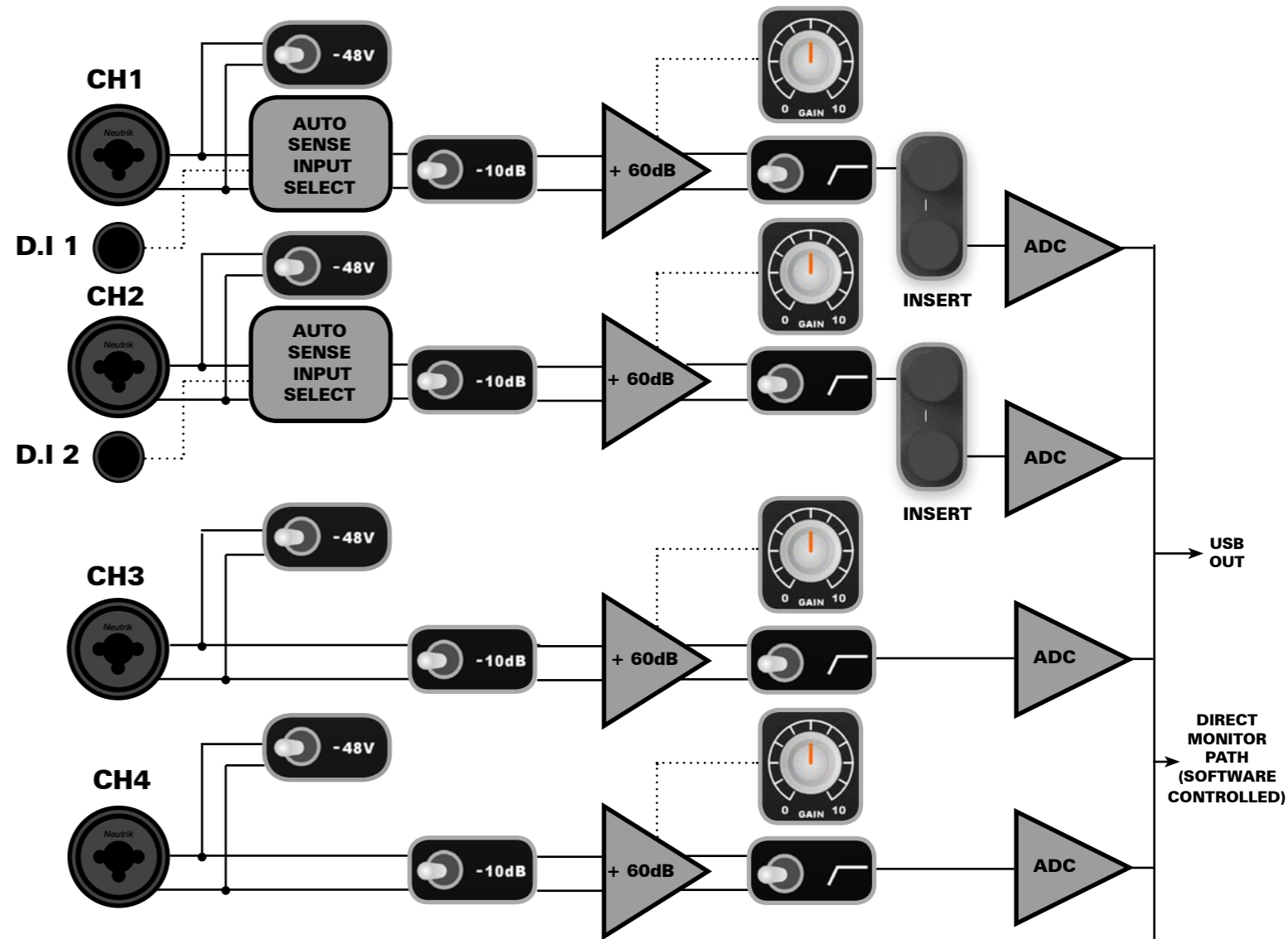

Input Specs		
<p>Microphone Input XLR Combi Female Pin 1: Chassis Ground Pin Pin 2: Hot (+ve) Pin 3: Cold (-ve) Input Impedance: >3k ohm Maximum Input Level: +22 dBu</p>	<p>DI Input 1/4" TS Jack Tip: Hot (+ve) Sleeve: Ground Input Impedance: >1Meg ohm</p>	<p>Insert Return 1/4" TRS Jack Tip: Hot (+ve) Ring: Cold (-ve) Sleeve: Chassis Ground Input Impedance: >10k ohm Maximum Input Level: +18 dBu Digital Reference: 0dBFS = +18dBu</p>
<p>Line Input 1/4" TRS Combi Jack Tip: Hot (+ve) Ring: Cold (-ve) Sleeve: Chassis Ground Input Impedance: >10k ohm Maximum Input Level: +32dBu</p>	<p>Insert Sends 1/4" TRS Jack Tip: Hot (+ve) Ring: Cold (-ve) Sleeve: Chassis Ground Output Impedance: >100 ohm Maximum Output Level: +22 dBu</p>	<p>Optical Inputs TOSLink Optical Connector ADAT: 8 channels @ 48kHz ADAT SMUX: 4 channels @ 96kHz S/PDIF: 2 Channels @ All sample rates</p>

Line Outputs

iD44 has four line outputs, these can be used for connecting monitors on the back panel in the form of balanced TRS jack connectors. The outputs are impedance balanced using the same topology as our flagship console, the ASP8024.

The outputs are fed from high quality DACs (Digital to Analogue Convertors) sending clean, linear audio to your speakers, perfect for critical listening.



You can use these outputs for more than just speakers. If you want to use hardware outboard equipment, you can send out up to four mono, or two stereo signals from these outputs, This is configured in the iD mixer software.

In order to keep your audio noise free, we would recommend against the use of unbalanced (TS, RCA.. etc) cables on the line outputs.

Headphone Output

iD44 features a two high current headphone amplifiers which are fed by separate DAC's and can be accessed from the headphone jack on the front of the unit.



These can be used instead of or alongside speakers to get an idea how your mix translates to headphones, or to provide artist headphone mixes

The headphone outputs can comfortably drive a wide range of headphone impedances meaning that you will get great sounding audio no matter what model of headphones you have.

Monitor Control

iD44 provides all of the excellent monitor control functionality as found on our consoles.

As such, it is possible to control main and alternative loudspeaker volumes with a perfectly matched stereo volume control on the main unit.



Accompanied by this monitor volume knob are permanently assigned hardware DIM & CUT switches. The level of DIM and ALT. loudspeaker trim can be adjusted in the iD mixer application.

Alongside these functions, three user programmable 'F' keys provide access to several useful monitoring features.

Monitor Control Features

- Volume control (perfectly matched)
- Alt. loudspeaker with programmable level (assignable to an 'F' key)
- DIM with programmable level
- CUT
- Mono Sum (assignable to an 'F' key)
- Polarity reverse (assignable to an 'F' key)

By using polarity reverse and mono sum it is possible to listen in sum or difference (mid or side) modes. This provides an excellent way to check mono compatibility and to also learn spatial tricks from your favourite reference material.



iD Button



The iD button switches iD44 into **ScrollControl** mode, allowing the encoder to be used as a scrollwheel for the computer. This gives you the ability to control plugin parameters and anything else that is scrollable. This works well for adding automation or setting parameters in a hands-on way.

To use **ScrollControl**, hover your mouse over whatever you want to control and rotate the encoder.

ScrollControl may act slightly different on different plugins or DAWs depending on how they have been programmed to work with scrolling. If you find it is too sensitive or not sensitive enough, you can try adjust your computer scrolling speed.

Talkback

The iD44 can take a talkback signal from a variety of places. You can assign one of the 4 analogue or 16 digital inputs as your talkback channel. When talkback is activated, signal from that channel is sent through one of the Cue mixes to the artist(s).



You can source the talkback audio from another audio device connected to your computer such as the built-in microphone. This allows you to free up an input channel on your iD44 that would otherwise be taken up, great for big sessions.

Details on how to set this up can be found in the 'Software' section of this manual.

Hardware Metering

The 8-segment hardware meters indicate playback level of the iD mixer app, so it is suggested that end users observe their DAW metering for input levels.

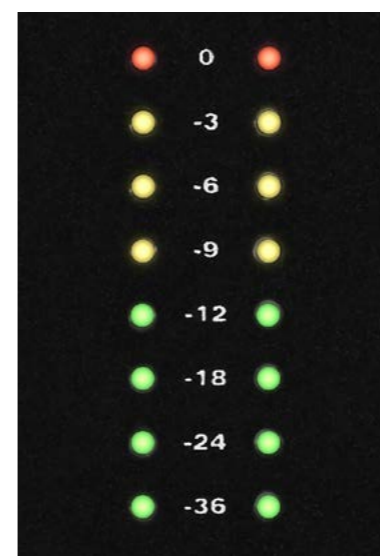

Status LED

The status LED indicates connection via USB to your computer. A solidly lit light means that there is stable communication between iD44 and your computer.

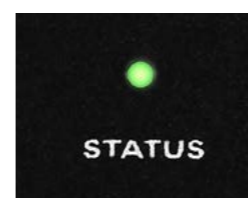

Kensington Lock

For those who work in educational establishments or in situations where your equipment is public facing and subject to possible theft opportunities, we have provided a Kensington lock hole to enable you to protect your iD44.



Software Features



Input Channels - Channel Types

The iD mixer application features three types of input channels:

- Mic Inputs**
 These are the inputs where you will see the signal from the iD44's four analogue inputs
- Digital Inputs**
 These are the inputs from the iD's optical inputs. The number of digital inputs present on the iD mixer application depends on the digital input type (S/PDIF or ADAT) and the sample rate being used.
- Daw Returns**
 These are the signals being played back from your DAW. The iD44 has 8 Daw Return Channels allowing you set up multiple cue mixes or sends to hardware outboard gear.

Using these three channel types, you can build up your main monitor mix and up to four additional cue mixes.

Its important to note that the iD mixer application only controls the monitoring of the iD44. Changes made to the iD mixer application won't affect the level present in your DAW or audio software.

Channel Features



Channel Name

By double clicking on the name of the channel you can rename it to help you organise your iD mixer application. You could name a channel 'Kick' or 'Snare' for example.

Phase Flip

Inverts the polarity of the signal by 180° to stop phase cancellation. This is useful if you are micing the rear of a guitar amplifier or the underside of a snare drum.

Pan Control

Allows you to send the audio to the left, to the right or anywhere between on your Main Monitor Mix or Cue Mixes.

Stereo Grouping

Allows you to group two adjacent channels together into a stereo channel with a single fader controlling the level of both channels. When a channel is stereo grouped, the pans will automatically be set to far left and far right.

Solo

The Solo button mutes all other channels other than the one that is currently solo'd. Multiple channels can be solo'd at one time.

Mute

The Mute button stops this channel from outputting audio whilst it is engaged.

Fader

The fader controls the amount of signal that is sent to currently selected mix. This can be set to anywhere between -inf dB to +6dB.

Meter

The meter shows the current signal level in dBFS. Should the signal level exceed 0dBFS then the peak indicators will illuminate red to indicate a peak. The peak indicators can be turned off by clicking in them. You can also turn off all peak indicators using **Alt + Click**.



Master Section Features

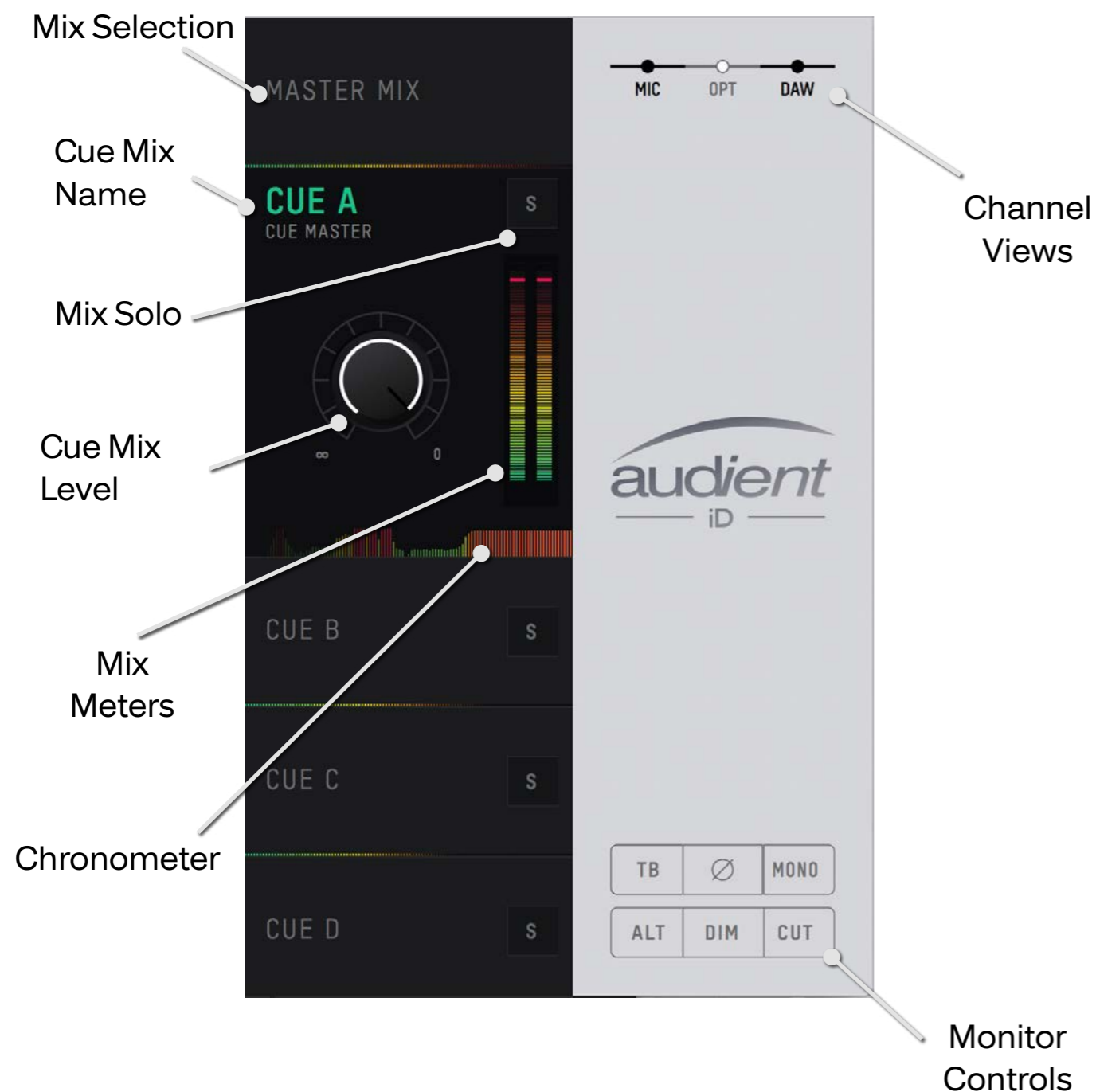

Channel Features

Mix Selection

Clicking on one of mixes allows you to make changes to that mix. When a mix is selected, it expands to reveal additional controls for that mix.

Cue Mix Name

Double clicking on a Cue Mixes name allows you to rename the Cue Mix. If for example you were creating mixes for four separate band members, you could name them 'Drummer', 'Guitarist', 'Bassist'... etc.

Mix Solo

The Solo button allows you to audition each of the Cue mixes through your monitors.

Mix level

The Mix level allows you to control the overall level of the Cue mix that is sent to the outputs.

Mix Meters

The Mix meters show the master signal level of the selected Mix.

Chronometer

The Histogram Meters allow you to see not only the current signal level but also the signal level from a few seconds previously.

This can be great to track down a sudden loud transient on a particular cue mix or to monitor the change in level over time as you make changes to a mix.

Channel Views

These three buttons allow you control which of the three channel types are shown in the mixer. If for example you weren't using the digital inputs for a particular project, you can simply hide the optical channels by clicking on the OPT control.

Monitor Controls

These six buttons control various aspects of the iD44's monitor controller capability. The function of each control can be found below:

- **TB (Talkback)**
The talkback button switches talkback on and off. More information regarding talkback and its various settings can be found in the 'System Panel' section of this manual.

- ∅ (Phase Flip)**
 Pressing this switch flips the phase of one side of the stereo field. Used in conjunction with the mono button, this can be a great way to remove centred elements from a mix. in order to hear the hidden elements of a mix.
- Mono**
 The mono button sums the stereo outputs down to mono. This can be used to quickly check the mono compatability of your mix to make sure it'll sound great almost anywhere!
- Alt**
 Alt allows you to quickly switch your monitor path to a secondary set of monitors to let you check how your mix translates on various speakers.
- Dim**
 Reduces the output level by a preset amount which can be great if you get a call or need to quickly chat to someone during a session.

- Cut**
 The cut button cuts the signal to the monitors.
- All these controls can be controlled from the iD44 itself, either by assigning them to an F-Key, or using the dedicated Dim and Cut controls.

Assigning F-Keys

Various functions of the iD mixer application can be assigned to the Function Keys of the iD44 to allow you to quickly control your monitoring at the click of a button.

To assign a monitor control to an F-Key, simply right click on the control and select the F-Key.

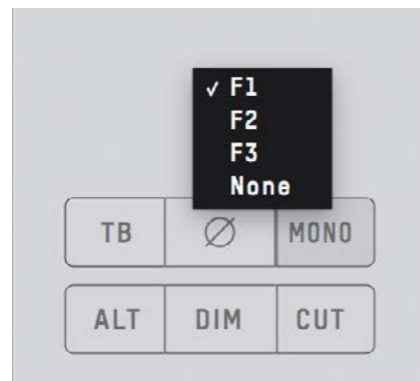

System Panel

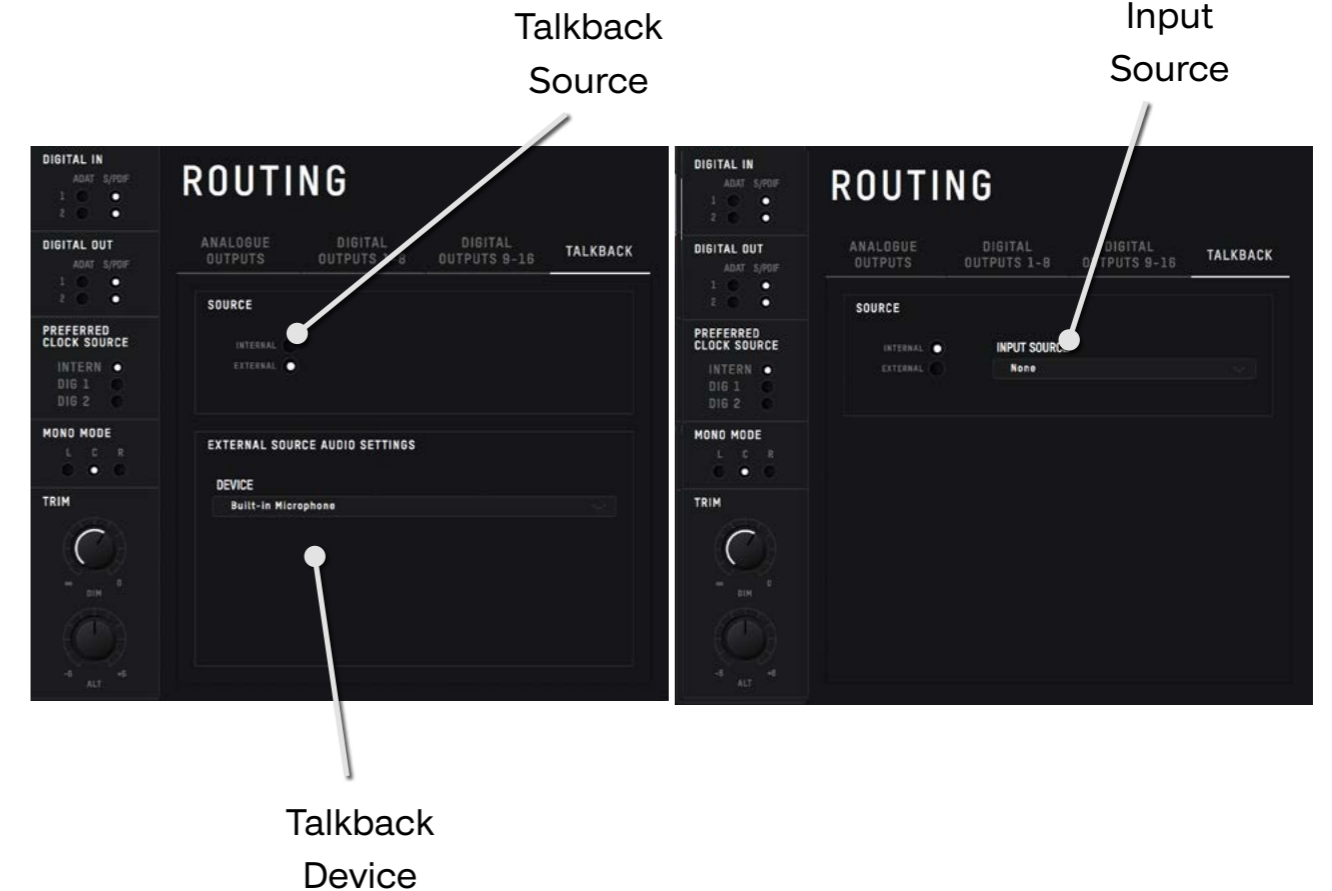

System Panel Features

Digital I/O Format

Allows you to select whether each optical input or output uses ADAT or S/PDIF digital format.

Preferred Clock Source

The Clock source can be selected from either the internal clock or one of the two optical inputs. More information about choosing a clock source can be found in the clocking section of this manual.

When using an external clock source the indicator beside the selector shows the current status of the clock on that input.

- Red - No clock signal detected on input
- Amber - A clock signal is detected but at a different sample rate to iD44
- Green - A clock signal is detected and is at the correct sample rate.

For an external clock source to be working correctly you would want the indicator to be green. If the indicator isn't green, iD44 will default back to the internal clock until it detects a valid clock input

Mono Mode

When the iD44's Mono feature is engaged this option controls whether the mono signal is sent to the left, right or both monitors.

Dim Level

When the iD44's dim button is pressed, this control defines how much the level is reduced by.

Alt Speaker Level

This control defines the level drop/boost when the iD44 is switched to ALT speaker mode. This is used to balance levels between different speaker brands or types.

Output Routing Selection

Opens the routing matrix for either the Analogue Outputs, Digital Output 1, Digital Output 2 or the Talkback channel

Routing Matrix

The Routing Matrix allows you to control the audio source for each of the iD44's outputs from the following options

- Main Mix - This takes signal from the Master Mix of the iD mixer. This is what is usually used for most standard playback.
- Alt - This takes signal the Master Mix but only when the Alt speaker mode. is active.

- Cue A, B, C, D - This takes signal from the four cue mixes which can be created using the iD mixer. Please note that the hardware volume control does not affect these mixes and the Cue's have sperate trims which can be adjusted when the cue mix is selected in the Main Mixer Window
- DAW THRU - This takes signal directly from the audio driver and bypasses both the routing and volume control of the iD mixer. This is best used with outboard equipment or monitor controllers where a full line level signal is required.

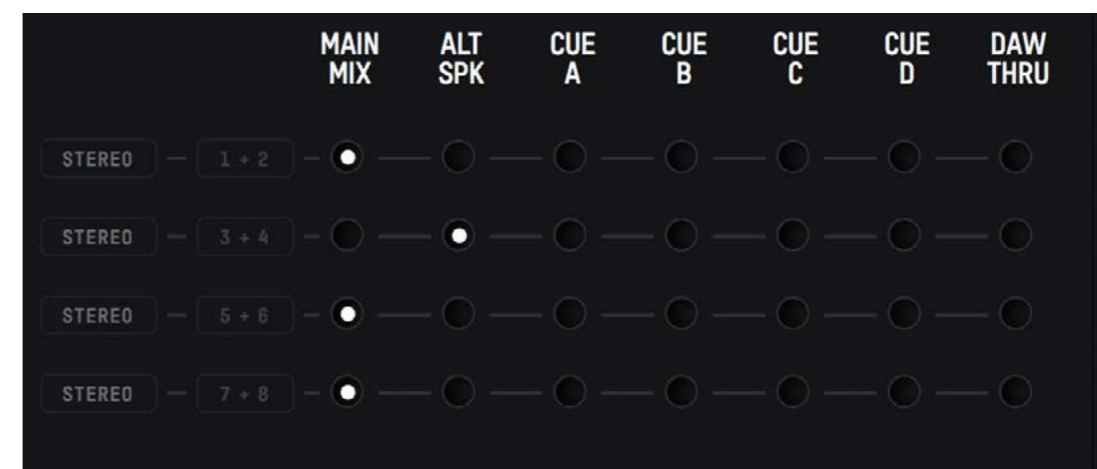

Talkback Source

The Talkback source allows the talkback input to be taken from on the iD44's internal inputs or from a device connected to the host computer (Such as a built-in microphone or USB microphone)

Talkback Device

If an external device is selected then this allows you to select which connected device is used.



Saving & Loading Mixer Presets

To allow you to quickly setup your iD mixer during a session you can save and quickly load various presets. This is great if you are moving between recording scenarios quite often.

Mixer presets can be saved and loaded in two ways:

- Using the File menu and selecting either Save or Open
- Using standard keyboard shortcuts :

Save: Mac - Cmd + S

Windows - Ctrl + S

Load: Mac - Cmd + O

Windows - Ctrl + O

Saving a Preset.

To save a preset, simply setup your mixer the way that you'd like to save. Then select File > Save as explained above. The mixer window should then show the Save dialog.



Simply enter the name of your preset and press save.

It is also possible to export your preset files in order to send them to friends or to simply save them within your DAW session files for easy recall later on. To do this, select Export Mixer Configuration at the base of the Save screen.

Loading a Mixer Configuration

To load a previously saved preset, select File > Open to bring up the Load screen.



The previously saved configuration will appear in a list. Select the configuration you wish to use and click Load.

You can also open a mixer configuration directly from your file by selecting Load From File.

Menu/Task Bar Icons

MacOS

On MacOS, the iD icon appears in the menu bar in the top right hand corner of the screen. This gives you quick access to various functions of the iD44.



Quit

Fully closes the iD mixer application.

About iD

Displays information regarding the current version of the iD mixer application.

Visit iD Knowledge Base

Opens a browser windows for the Audient Helpdesk with helpful articles and FAQ's.

Check for Updates

The iD app will check with the Audient update server for any available firmware updates for iD44.

Windows

The Windows taskbar Icon has all the options of the MacOS menu bar icon but also includes some Windows Specific options

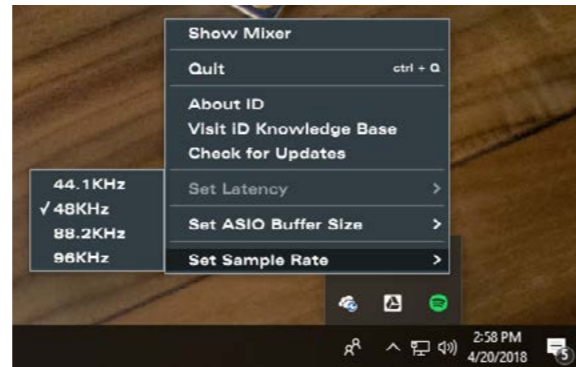

Set Sample Rate

Sets the operating sample rate of iD44. 44.1, 48, 88.2 and 96kHz are the four options available.

Set ASIO Buffer Size

Sets the buffer size of the iD44 between 16 and 8192 samples. Higher sizes will take processing load off your computer but will cause increased latency

Standalone Operation

When in standalone mode, the iD mixer settings are saved onto the iD44 itself so that a mixer setting can be instantly recalled as soon as the iD44 is powered on without having to connect the iD44 to a computer. This is great for setting up complex tracking setups in remote locations.

To setup Standalone mode, first setup the iD mixer in the way that you wish to be saved onto your iD44. This includes your digital I/O settings, output routings and talkback settings in the System panel.

Now navigate to the Setup menu and select **Store Standalone State**. The iD Mixers current configuration will then be saved onto the iD44 itself, ready to be recalled when the iD44 is next powered on.



Firmware Update

Occasionally, Audient will release a firmware update for the iD44 in order to address bugs, improve compatibility and add new features. Therefore you may wish to check occasionally for any updates.

This can be done by navigating to the **Window** menu and selecting **Check for Updates**.

The iD mixer application will then check with our update server if any updates for the iD44 are currently available. If there are then you will be prompted to install them onto the iD44.

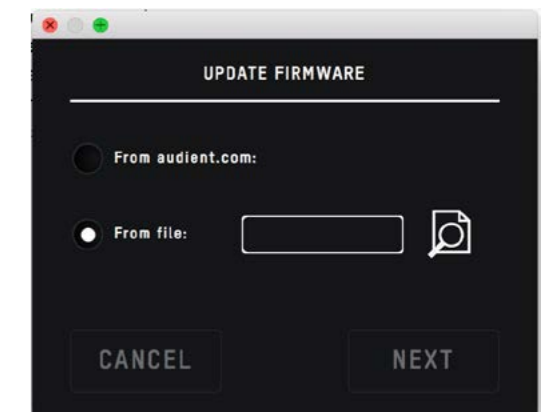

If you then click next, you'll be prompted to stop any playback through the iD44. Click Update and the update will begin. The iD44 may turn off a number of times

during the process. Once the update has completed, fully reboot the iD44 by flicking the power switch off, waiting for a few seconds and then flicking it back on again.

Audient Helpdesk

If at any point you need assistance with your iD44, the Audient Help desk can be opened directly from the iD mixer. Open the Window Menu and select Visit Audient iD Knowledge Base.

This will open a browser window for the Audient Help desk. Here you will find numerous articles to help you get your iD44 setup best for you.

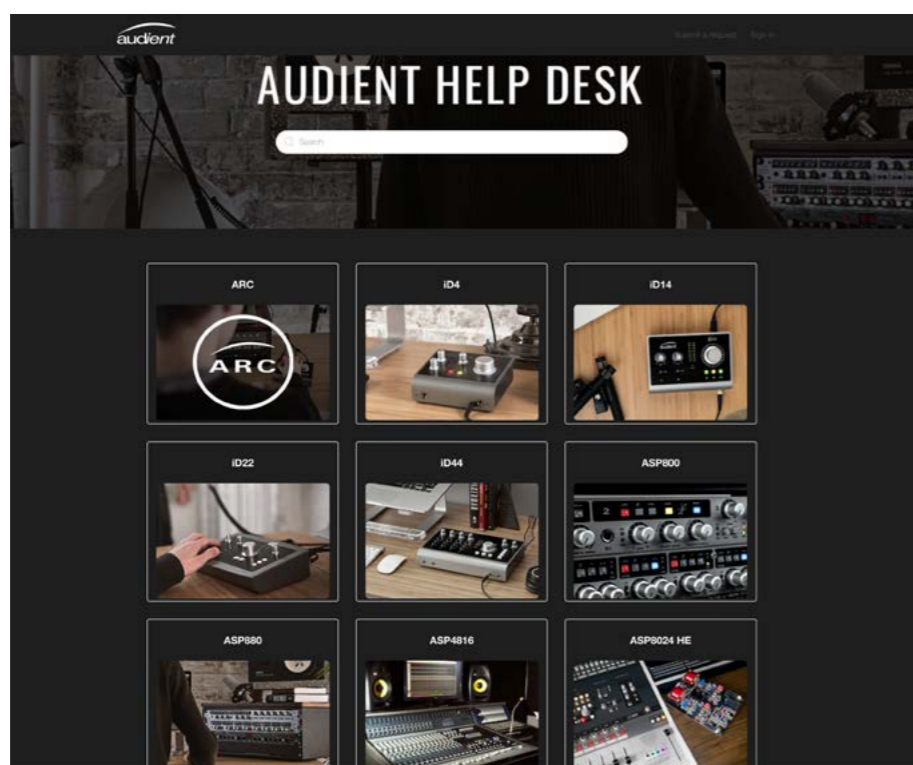

Keyboard Shortcut Index

To allow you to find all shortcuts for the mixer application in one place without having to go through each page of this manual please refer to this table:

Location	Mac	Windows	Description
Faders	Alt + Click	Alt + Click	Resets fader to unity gain (0 dB)
Pans	Alt + Click	Alt + Click	Resets pan pots to central position
Solos	Cmd + Click	Ctrl + Click	Clears all solos if clicking on a solo'd channel
			Overrides all other solos (for solo exclusive) if clicking on an unsolo'd channel
Meters	Alt + Click	Alt + Click	Clicking on peak hold indicator will clear all clip indicators
Mixer Screen	Cmd + S	Ctrl + S	Save mixer configuration
	Cmd + O	Ctrl + O	Load mixer configuration
View Modes	Cmd + 1	Ctrl + 1	View Mic/Line Inputs
	Cmd + 2	Ctrl + 2	View Optical (Digital) Inputs
	Cmd + 3	Ctrl + 3	View DAW Mix Inputs
	Cmd + 4	Ctrl + 4	View System Panel

Please check the iD44 page online at www.audient.com/products/iD44 for the latest mixer application updates.

More shortcuts may be added without notification.



DAW Setup



Operation with Pro Tools

Once iD44 has been successfully installed following the steps detailed in this manual, launch Pro Tools and ensure that a new session is created at the desired sample rate (if clocking internally) or at the rate of the clock source (if clocking externally).

If using Windows, make sure that you have set the correct latency and buffer size settings in the iD app before opening a project. Changing these settings will result in ProTools needing to restart.

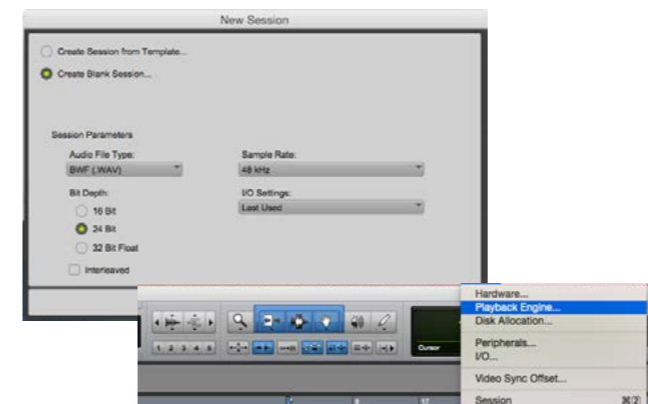

Playback Engine

Go to Setup > Playback Engine... and ensure that iD44 is set as the active playback device.

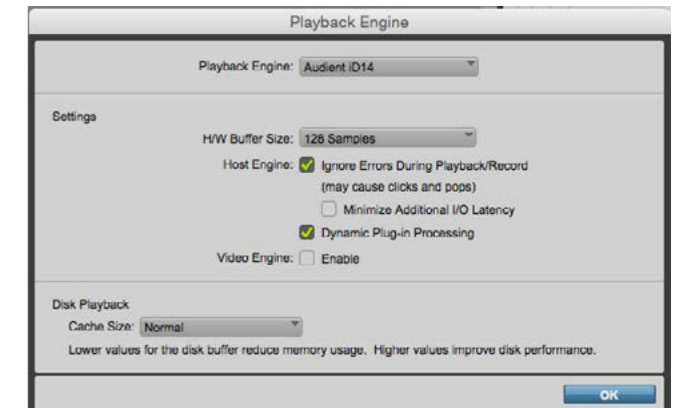

I/O Setup

Go to Setup > I/O... to label your inputs and outputs and ensure that iD44 is correctly reporting 20-inputs and 24-outputs to and from Pro Tools. Note that analogue outputs 1-8 are the DAW playback channels in the iD mixer and can either be routed through the iD mixer or hard-wired directly from Pro Tools to the physical outputs.

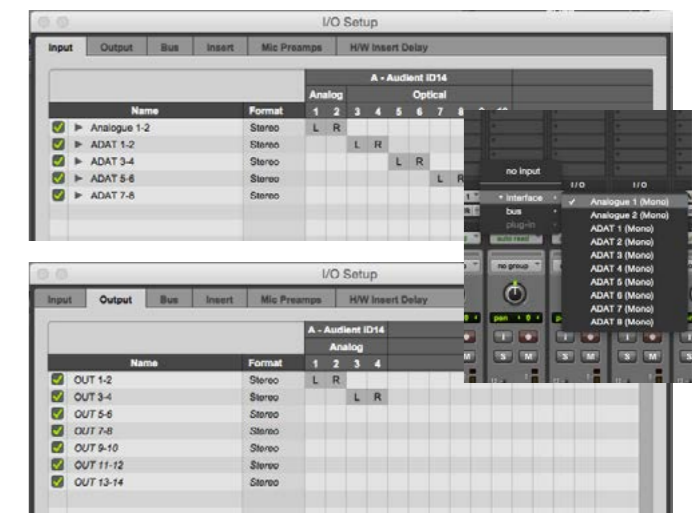

For more Pro Tools information consult your Avid user manuals & documentation.



Operation with Logic Pro

Once iD44 has been successfully installed following the steps detailed after page 6 of this manual, launch Logic Pro and check the following:

Logic Pro > Preferences > Audio

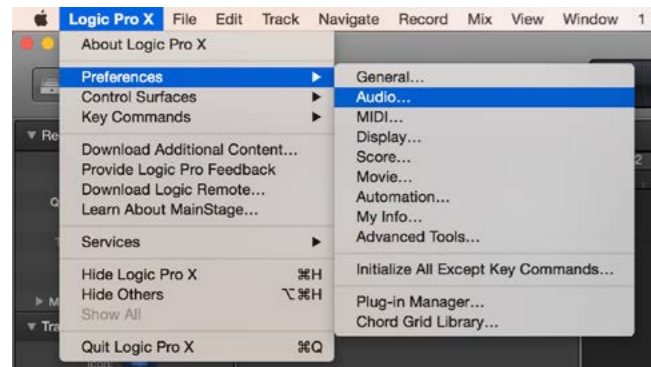

Ensure that iD44 is selected as the active audio device and set the buffer size (to affect system latency). If you are experiencing issues with playback stability and CPU loading, try increasing the buffer size. This appears with "overload" errors and/or pops and clicks and distortion in the audio.

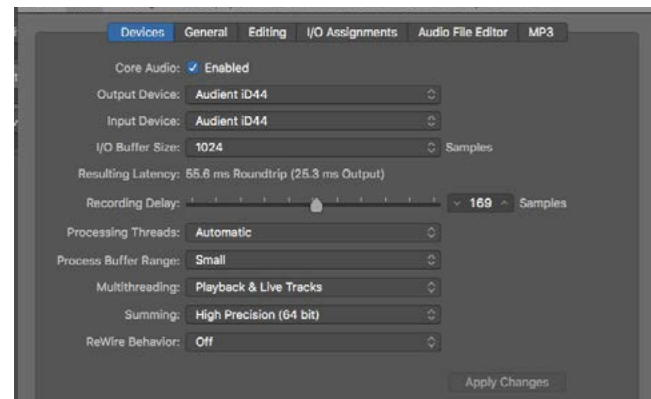

If you are using the iD mixer to monitor input signals while recording, be sure to disable Logic's software monitoring to avoid phasing as the same source will be heard twice with a short delay between the low latency DSP signal and the delayed software monitoring signal.

Assigning I/O

All of iD44's input and output channels will be available to Logic for routing. There are a total of 20-inputs and 24-outputs reported from the driver.

You can rename input and output channels to whatever you wish using the I/O label function. This is a great way to keep things organised.



Mix > I/O Labels

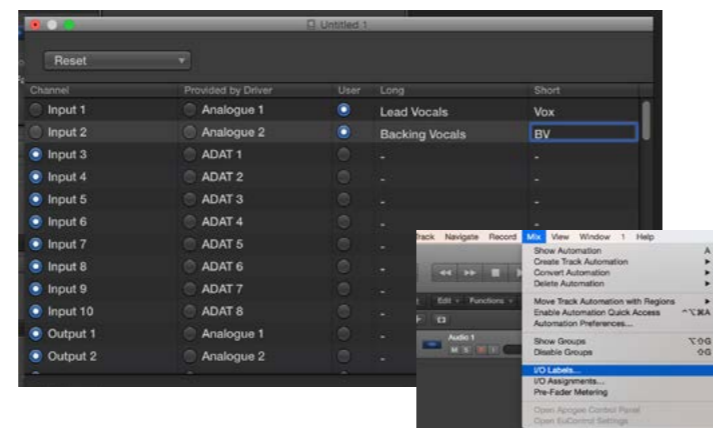

Operation with Logic Pro

If you are using an external clock source (ADAT or S/PDIF) to clock iD44, please ensure that your Logic Pro project is set to the same sample rate when recording and playback in a session, otherwise things may sound a bit sharp or flat!

File > Project Settings > Audio

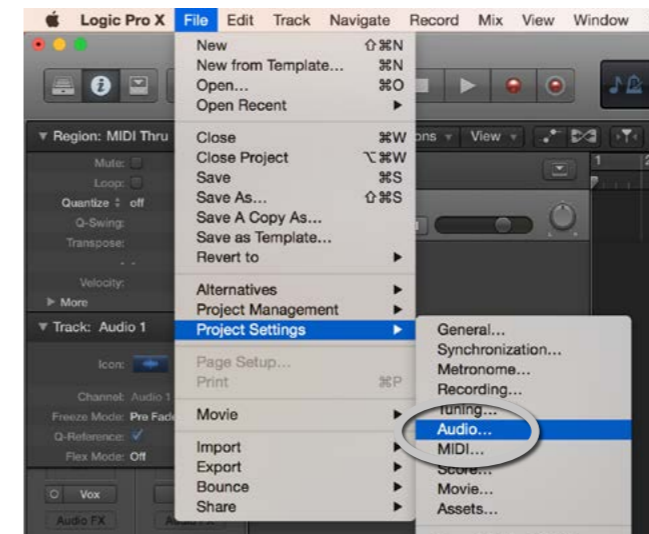

If you are using the internal clock in iD44, setting the sample rate via Logic Pro will update the iD44 sample rate to follow your session.

There may be a slight pause as the system re-clocks. This is normal.

This can be verified in Audio MIDI Setup.

Macintosh HD > Applications > Utilities

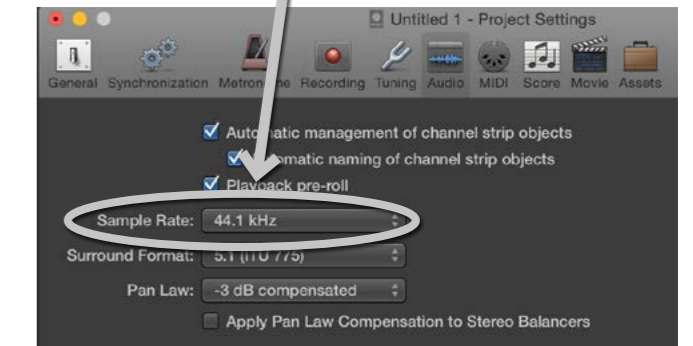
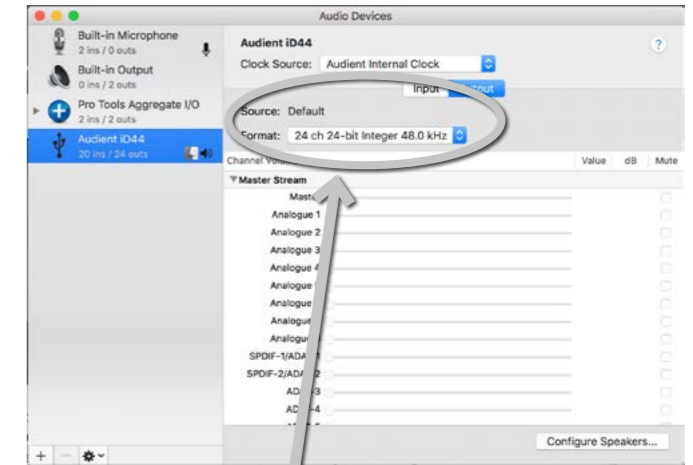

For more Logic Pro information please consult your Apple user manuals & documentation.



Operation with Cubase / Nuendo

Once iD44 has been successfully installed following the steps detailed after page 6 of this manual, launch Cubase or Nuendo and head straight for the Devices menu:

Devices > Device Setup...

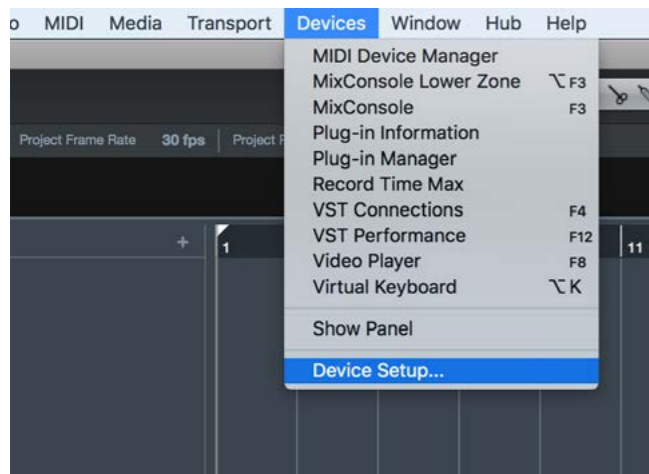

Select VST Audio System in the devices menu.

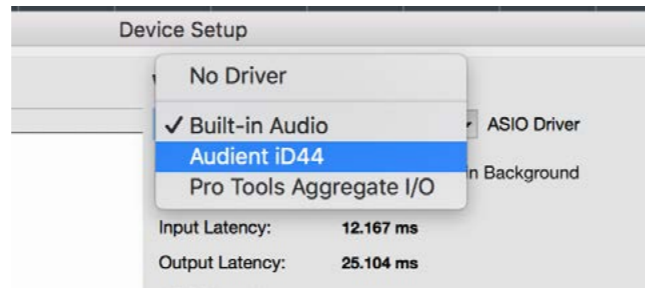
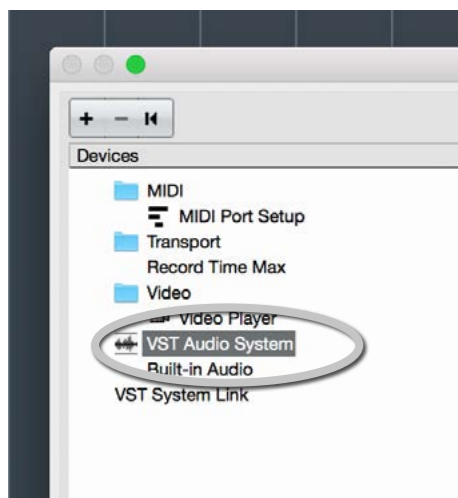

Select Audient iD44 in the menu to ensure that Cubase / Nuendo addresses the iD44 device driver. You will be asked if this is OK, select 'switch'.

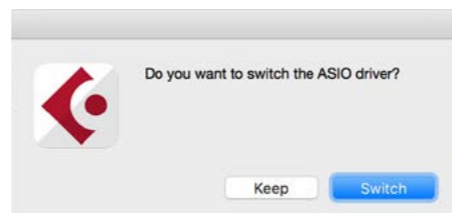

Select Audient iD44 in the devices menu...

Here you will see the main iD44 information, where clock sources can be set as well as activating i/o ports. Be sure to click Externally Clocked if clocking from another digital device via ADAT or SPDIF.

Operation with Cubase / Nuendo

Buffer sizes can be set in the control panel within the VST devices display. It is ideal to keep them quite high to reduce CPU loading if you use the iD mixer as the input monitoring device while recording.



I/O ports can be renamed in the device panel such that they better represent what you connect to them (for example Main Monitors, Headphones). This is useful as any names chosen here will be those displayed when assigning i/o on track input/output channel routing.

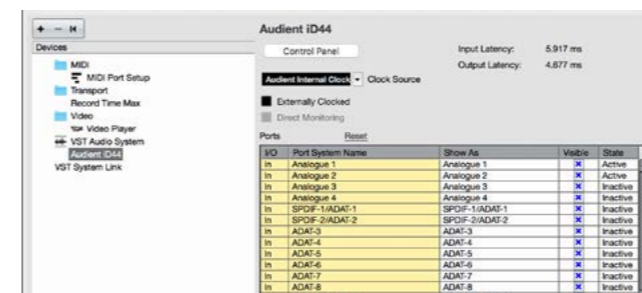

Close the VST device setup panel and navigate to the VST connections panel:

Devices > VST Connections (F4)



Here you can ensure that all buses have been created in Cubase / Nuendo and therefore all ports are addressable in your session. Add new buses and assign them to the necessary i/o if required.

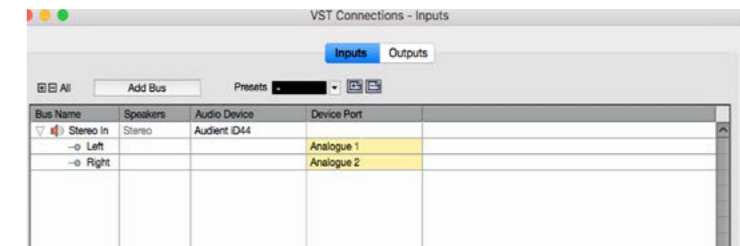

Bus types can be set (mono / stereo) and the VST control room section can also be used. For more information regarding set-up please consult your Steinberg user manuals and documentation.

Operation with Ableton Live

Once iD44 has been successfully installed following the steps detailed after page 6 of this manual, launch Ableton Live and head straight to:

Live > Preferences

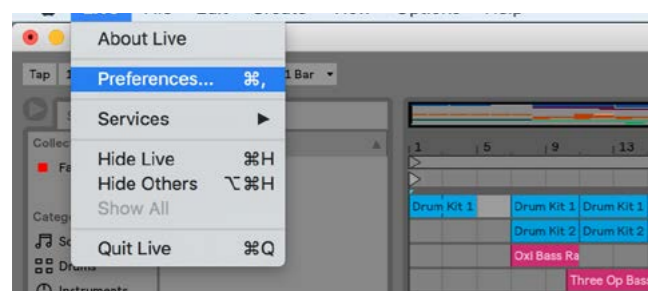

Here navigate to the Audio tab and make sure that iD44 is assigned as the playback device.

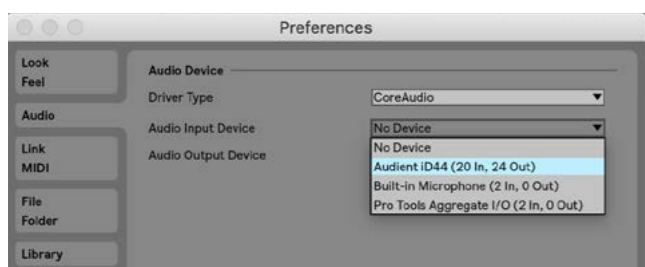

For more information about setting up audio i/o refer to your Ableton Live user manuals & documentation.

In the Live Audio Preference panel you can set an appropriate buffer size (this can be kept high if you are monitoring input signals for recording via the iD mixer. Ensure that iD44 reports as a 20-in, 24-out device to Live.

If necessary you can limit the number of i/o channels reported as active inputs (from the driver) in Live by using the input and output config tabs.

This is an excellent feature to help reduce CPU loading if all channels are not required.

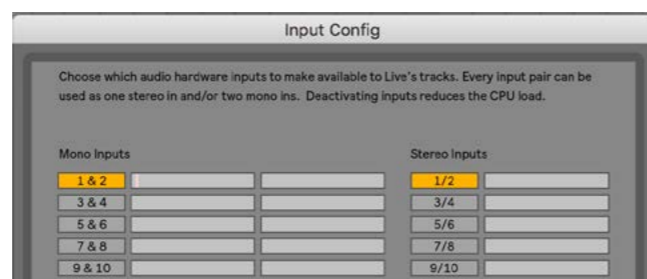

Troubleshooting

- "The unit will not power on"

Double check that the 12V adaptor is properly connected and that the regional adaptor pins of the power supply are fully pushed into place.

- "I get clicks and pops on DAW playback"

This is most likely to do with setting the buffer size too low for your computer. This can be caused by running very large projects with a lot of plugins and virtual instruments. Experiment with higher buffer sizes. Typically you want small buffer sizes for tracking or recording software synths to keep the latency low. However when mixing it is fine to set a slightly higher buffer size as latency is not so much of a problem.

- "When I connect to my computer, I cannot play any audio out from iD44"

Firstly double check that the USB cable connecting iD44 to your computer is functional and attached at both ends.

Double check that iD44 is set as the active playback device in your DAW and computer:

System Preferences > Sound > Output Tab > Audient iD44 (OSX)

Control Panel > Hardware and Sound > Sound > Manage Audio Devices > Audient iD44 (Windows)

Launch the iD mixer application to activate communication between your computer and iD44. This only needs to be done once straight after power up. Once iD44 is set to the operational state you desire, you can quit the iD application and it will continue to function as intended.

In the software mixer, locate the DAW channels by pressing the DAW view button and increase the level of DAW 1+2 fader.

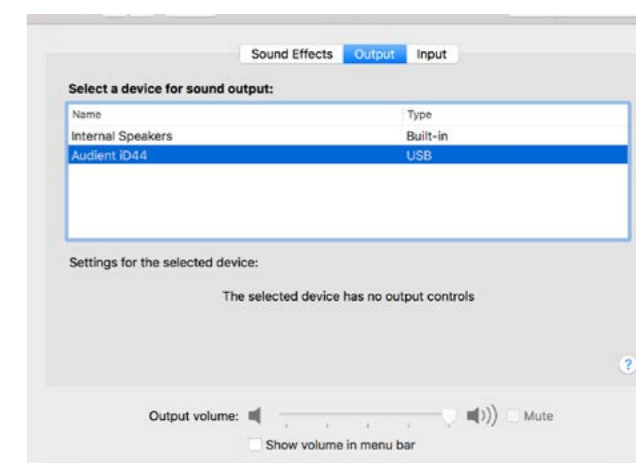

Troubleshooting

- “I have clocking issues which include iD44 not locking to external ADAT or SPDIF devices or operating at the incorrect rate compared to my session”

If there is an issue with syncing of an external device, the Status LED in the System Panel will be red or yellow. If the status light is red then iD44 cannot detect a clock signal from an external device, and yellow if it can detect a signal at the wrong sample rate.

To change sample rate in OSX go to Audio MIDI Setup found by navigating to the folder:

Macintosh HD > Applications > Utilities > Audio MIDI Setup

Ensure that Audient iD44 is seen as an audio device (Window Menu > Show Audio Window).

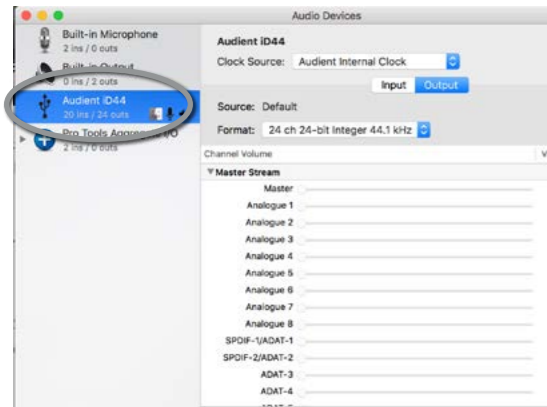

Double check that an appropriate clock source is selected (Internal for master operation), ADAT or S/PDIF clock for external slave operation. Ensure that you see the correct sample rate displayed in the Format drop-down menu.

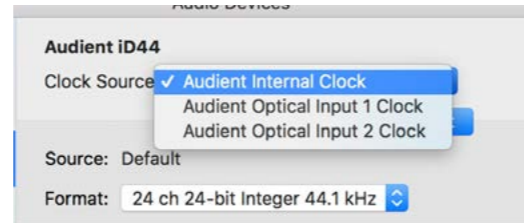

If you are using Windows, go to the iD icon in the system tray and right click on it. This will bring up some settings including sample rate. Alternatively you can alter these setting in the Setup tab of the iD app.

Change the sample rate to match that of the external ADAT device and session.



Troubleshooting

- “How do I reset the iD mixer application to it’s default state?”

To reset the mixer application, quit the iD app completely, then navigate to the following folder and delete the state.xml file (it will replenish upon a fresh launch of the application)

Macintosh HD > User > Library > Application Support > Audient > iD > state.xml

(C:) > Users > yourusername > AppData > Roaming > Audient > iD > state.xml

Do not delete the parent folder as this will also contain your iD mixer presets.

- “How do I make sure I have the latest version of iD firmware/software?”

To check for the latest updates to the iD desktop mixer application please visit: www.audient.com/products/iD44 download the package and install.

You will be made aware of firmware releases from the iD app when connected to the internet. Please refer to earlier in this user manual for more information regarding firmware update.

FAQs

For more information and bug support, please search our online Help Centre which can be found here:

audient.com/support



For technical support please create a ticket in our online support system, which can also be found in the support section of our website (see link above).

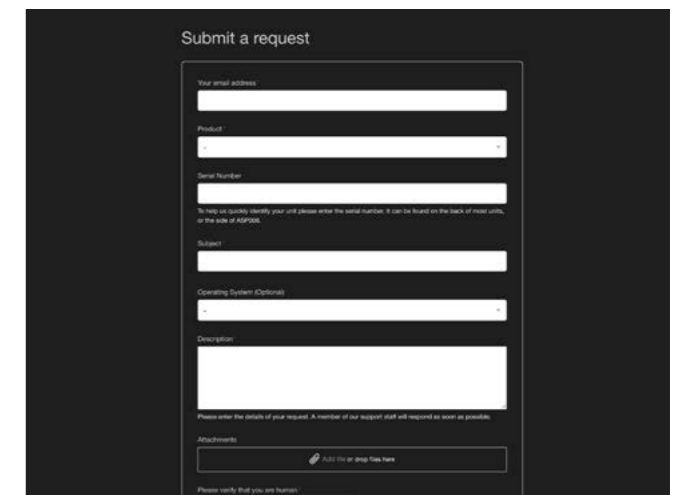



D.I / INSTRUMENT INPUT: (Channel 1)

D.I GAIN: 0 to 60dB
 MAXIMUM INPUT LEVEL: +10 dBu
 INPUT IMPEDANCE: 1MegΩ unbalanced
 FREQUENCY RESPONSE: ±0.5 dB 10Hz to 50kHz
 THD+N @ 0dBu (1kHz): <0.3%
 SNR: 95 dB A-weighted

1/4" TS JACK: Tip (Hot) & Sleeve (Shield)

ANALOGUE TO DIGITAL CONVERTER (ADC 1 & 2): (Measured via Insert Returns under AES-17)

MAXIMUM INPUT LEVEL: +18 dBu (0 dBFS digital maximum)
 DIGITAL REFERENCE LEVEL: +18 dBu = 0 dBFS
 INPUT IMPEDANCE: >10k Ω Balanced
 FREQUENCY RESPONSE: ±0.5 dB 10Hz to Fs/2 (Nyquist)
 CROSSTALK: -115 dBu @ 1kHz & 10kHz
 THD+N @ -1dBFS (1kHz): <0.0008% (-103dB dB)
 DYNAMIC RANGE: 121 dB un-weighted

1/4" TRS JACK: Tip (Hot), Ring (Cold) & Sleeve (Shield)

DIGITAL TO ANALOGUE CONVERTER (DAC 1 & 2): (Measured under AES-17 at line outputs 1 & 2)

MAXIMUM OUTPUT LEVEL: +18 dBu (0 dBFS digital maximum)
 DIGITAL REFERENCE LEVEL: +18 dBu = 0 dBFS
 OUTPUT IMPEDANCE: <100 Ω
 FREQUENCY RESPONSE: ±0.5 dB 10Hz to Fs/2 (Nyquist)
 CROSSTALK: <-118 dBu @ 1kHz & 10kHz
 THD+N @ -1dBFS (1kHz): <0.0006% (-104dB)
 DYNAMIC RANGE: 124 dB un-weighted, 127 dB A-weighted
 1/4" TRS JACK: Tip (Hot), Ring (Cold) & Sleeve (Shield)

MICROPHONE PREAMPLIFIER: (measurement includes ADC signal path)

MIC GAIN: 0 to 60dB
 LINE GAIN: -10 to 50dB
 PHANTOM POWER: 48V ±4V @ 10mA channel (12VDC only)
 MIC EIN: <-126.0 dBu
 CMRR: >80 dB @ 1kHz
 MAXIMUM INPUT LEVEL: +18 dBu (+28dBu with pad)
 INPUT IMPEDANCE (Mic): 3k Ω balanced
 INPUT IMPEDANCE (Line): 10k Ω balanced
 FREQUENCY RESPONSE: ±0.5 dB 10Hz to 65kHz
 CROSSTALK: <-90 dBu @ 1kHz & 10kHz
 THD+N @ 0dBu (1kHz): <0.003% (-96dBu)
 SNR: 96 dB

XLR COMBI FEMALE: Pin 2 (Hot), Pin 3 (Cold) & Pin 1 (Shield)
 1/4" TRS JACK: Tip (Hot), Ring (Cold) & Sleeve (Shield)

HEADPHONE OUTPUT / (DAC 3 & 4): (Measured under AES-17 at phones output)

MAXIMUM OUTPUT LEVEL: +14 dBu (0 dBFS digital maximum)
 DIGITAL REFERENCE LEVEL: +14 dBu = 0 dBFS
 OUTPUT IMPEDANCE: <50 Ω unbalanced
 FREQUENCY RESPONSE: ±0.5dB 10Hz to Fs/2
 CROSSTALK: <-110 dBu @ 1kHz & 10kHz
 THD+N @ -1dBFS (1kHz): <0.0008% (-103 dB)
 DYNAMIC RANGE: 124 dB un-weighted, 111 dB A-weighted
 MAXIMUM LEVEL into 30 Ω: +7.5 dBu 0.003% THD+N Power: 225mW
 MAXIMUM LEVEL into 60 Ω: +10.2 dBu 0.002% THD+N Power: 210mW
 MAXIMUM LEVEL into 600 Ω: +14.2 dBu 0.001% THD+N Power: 54mW

1/4" TRS JACK: Tip (Left), Ring (Right) & Sleeve (Shield)

DIGITAL INPUT:

16-CHANNEL ADAT: 44.1kHz to 48.0kHz
 8-CHANNEL ADAT: 88.2kHz to 96.0kHz SMUX
 STEREO S/PDIF / TOSLINK: 44.1kHz to 96.0kHz (Stereo)

USB2.0 HIGH SPEED:

No. of INPUT CHANNELS: 20 (4 Analogue, 16 Digital)
 No. of OUTPUT CHANNELS: 24 (8 Analogue, 16 Digital)
 CONNECTOR: USB Type-C
 INCLUDED CABLES: 1.5m USB 2.0 Type-C to USB Type-C
 1.5m USB 2.0 Type-C to USB Type-C

DSP MIXER LATENCY: ROUND TRIP (in-to-out)
 44.1kHz 0.677ms
 48.0kHz 0.625ms
 88.2kHz 0.354ms
 96.0kHz 0.323ms



Warranty Statement

Your iD44 comes with a manufacturer's warranty for one year (12 months) from the date of despatch to the end user.

The warranty covers faults due to defective materials used in manufacture and faulty workmanship only.

During the warranty period Audient will repair at its discretion or replace the faulty unit provided it is returned carriage paid to an authorised Audient service centre. We will not provide warranty repair if in our opinion the fault has resulted from unauthorised modification, misuse, negligence or accident.

We accept liability to repair or replace your iD44 as described above. We do not accept any additional liability. This warranty does not affect any legal rights you may have against the person who supplied this product - it is additional to those rights.

Warranty Limitations

This warranty does not cover damage resulting from accident or misuse. The warranty is void unless repairs are carried out by an authorised service centre. The warranty is void if the unit has been modified other than at the manufacturer's instruction. The warranty does not cover components which have a limited life, and which are expected to be periodically replaced for optimal performance. We do not warrant that the unit shall operate in any other way than as described in this manual.

Tel: 0044 1256 381944
audient.com

Service Information

iD44 contains no user-serviceable components, please refer to qualified service personnel for diagnosis and repair. Your warranty will be void if you tamper with the device at component level. If you have any questions with regard to the repair, please contact Audient Ltd.

If your unit is in warranty, please contact your dealer directly for a repair or replacement (at the discretion of the dealer).

For out of warranty repairs, please contact Audient Ltd, after which a Return Materials Authorization (RMA) number will be assigned. This number will serve as a reference for you and helps facilitate and expedite the return process. When the unit is returned please include this RMA number along with a description of the fault inside the packaging box.

To request an RMA, access technical support & FAQs, ask for troubleshooting assistance or make an enquiry, please visit: www.audient.com/support

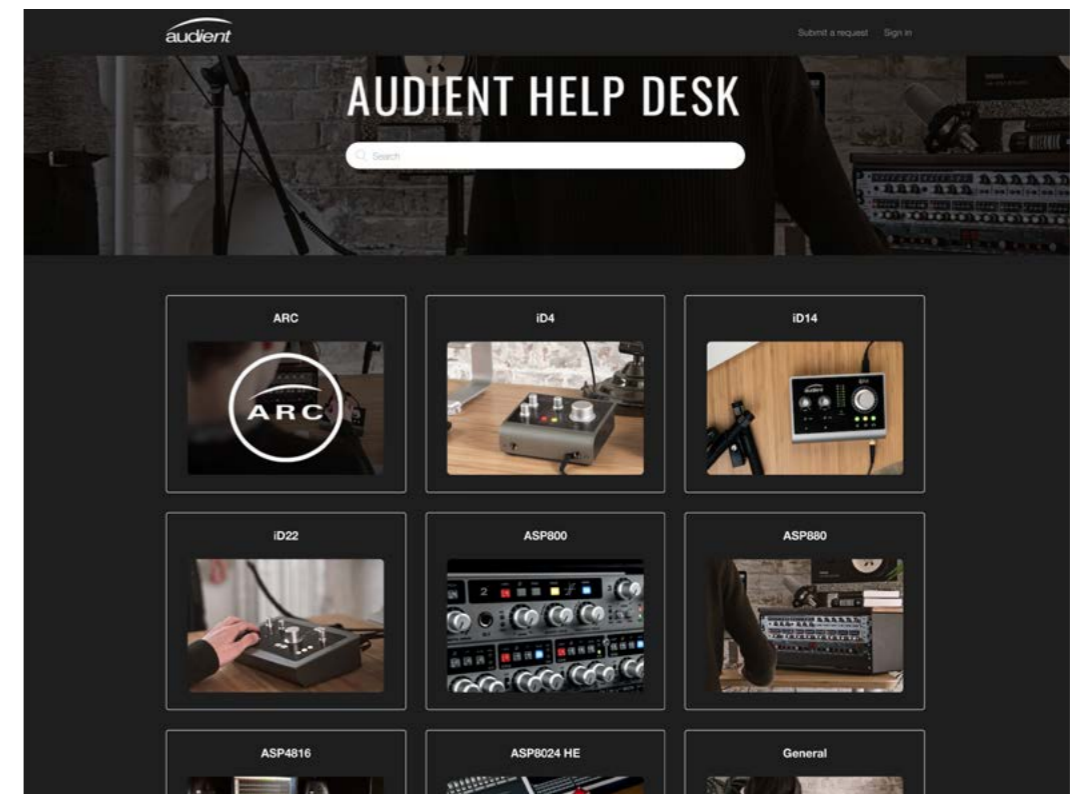

A	Amperes
ADAT	Alesis Digital Audio Tape
ADC	Analogue to Digital Converter
DAW	Digital Audio Workstation
ASP	Analogue Signal Processing
CPU	Central Processing Unit
CUE	Artist Headphone Mix
DAC	Digital to Analogue Converter
dB	Decibel
dBu	Decibel referenced to 0.775Vrms = 0 dBu
dBFS	Decibel Full Scale
DC	Direct Current
D.I	Direct Injection (Instrument Input)
DoC	Declaration of Conformity
DSP	Digital Signal Processing
EQ	Equaliser
FAQ	Frequently Asked Questions
FCC	Federal Communications Commission
GB	Gigabyte
GUI	Graphical User Interface
HPF	High Pass Filter
HV	High Voltage
i/o	Input / Output
JFET	Junction Field Effect Transistor
LED	Light Emitting Diode
RoHS	Restriction of Hazardous Substances
RAM	Random Access Memory
S/PDIF	Sony Philips Digital Interface Format
THD+N	Total Harmonic Distortion + Noise
TRS	Tip Ring Sleeve (1/4" Jack Balanced)
TS	Tip Sleeve (1/4" Jack Unbalanced)
USB	Universal Serial Bus
V	Volts
XLR	Extra Live Return, Extremely Low Resistance, Canon X Series, Latching, Resilient Rubber Compound... or make up your own!