



Fast Track Solo™ Guide

Legal Notices

© 2013 Avid Technology, Inc., ("Avid"), all rights reserved.
This guide may not be duplicated in whole or in part without the written consent of Avid.

Avid, the Avid logo, Fast Track Solo, and Pro Tools are either trademarks or registered trademarks of Avid Technology, Inc. All other trademarks contained herein are the property of their respective owners.

This product may be protected by one or more U.S. and non-U.S. patents. Details are available at www.avid.com/patents.

Product features, specifications, system requirements, and availability are subject to change without notice.

Guide Part Number 9329-65277-00 REV A 02/13

Documentation Feedback

At Avid, we are always looking for ways to improve our documentation. If you have comments, corrections, or suggestions regarding our documentation, email us at [***techpubs@avid.com***](mailto:techpubs@avid.com).

Contents

Chapter 1. Introduction to Fast Track Solo	1
Fast Track Solo Features	1
Registration	2
System Requirements and Compatibility	2
Conventions Used in This Guide	2
About www.avid.com	3
Chapter 2. Controls and Connectors	5
Front Panel	5
Back Panel	7
Chapter 3. Installing Drivers and Making Connections	9
Installing Fast Track Solo Drivers	9
Hardware Connections	10
Chapter 4. Using Fast Track Solo	11
Setting the Output Level	11
Recording Microphones	11
Recording Instruments	11
Setting Recording Levels	11
Direct Monitoring	12
Sample Rate, Buffer Size, and Bit Depth	12
Appendix A. Compliance Information	15
Environmental Compliance	15
EMC (Electromagnetic Compliance)	16
Safety Compliance	17

Chapter 1: Introduction to Fast Track Solo

Welcome to the Fast Track Solo™ audio interface from Avid®. Fast Track Solo provides your iPad or USB 2.0-equipped computer with two channels of analog audio input and output, phantom power, and headphone monitoring. Fast Track Solo includes a professional-quality microphone preamp, an instrument-level input, and 24-bit/48 kHz analog-to-digital and digital-to-analog converters.

Fast Track Solo integrates seamlessly with Pro Tools® software, and is compatible with third-party audio applications that support the Core Audio (Mac) or ASIO (Windows) standard.

Fast Track Solo Features

- 1 front panel XLR input connector for microphone input with 48V phantom power for condenser microphones
- 1 front panel 1/4-inch input connector for instrument-level input (such as from an electric guitar or bass)
- 1/4-inch stereo headphone output with dedicated volume control
- Up to 24-bit, 48 kHz operation
- RCA stereo line-level outputs
- Direct Monitor button
- Front panel Signal and Clip indicators for each channel
- USB bus powered operation
- Class compliant operation
- Pro Tools compatible
- Core Audio and ASIO support

Registration

Review the enclosed Registration Information Card and follow the instructions on it to quickly register your purchase online. This is one of the most important steps you can take as a new user. Registering your purchase is the only way you can be eligible to receive:

- Information regarding technical support
- Future upgrade offers
- Limited warranty on hardware

Hardware Warranty

Your warranty can be found on the Registration Information Card.

System Requirements and Compatibility

Fast Track Solo can be used with an Avid-qualified computer running Pro Tools software or third-party Core Audio- or ASIO-compatible software.

Avid can only assure compatibility and provide support for hardware and software it has tested and approved.

For complete system requirements and a list of qualified computers, operating systems, hard drives, and third-party devices, visit:

www.avid.com/compatibility

Conventions Used in This Guide

All of our guides use the following conventions to indicate menu choices and key commands:

Convention	Action
File > Save	Choose Save from the File menu
Control+N	Hold down the Control key and press the N key
Control-click	Hold down the Control key and click the mouse button
Right-click	Click with the right mouse button

The names of Commands, Options, and Settings that appear on-screen are in a different font.

The following symbols are used to highlight important information:



User Tips are helpful hints for getting the most from your system.



Important Notices include information that could affect your data or the performance of your system.



Shortcuts show you useful keyboard or mouse shortcuts.



Cross References point to related sections in this guide and other Pro Tools guides.

About www.avid.com

The Avid website (www.avid.com) is your best online source for information to help you get the most out of your Avid audio system. The following are just a few of the services and features available.

Product Registration Register your purchase online.

Support and Downloads Contact Avid Customer Success (technical support); download software updates and the latest online manuals; browse the Compatibility documents for system requirements; search the online Knowledge Base or join the worldwide Avid audio community on the User Conference.

Training and Education Study on your own using courses available online or find out how you can learn in a classroom setting at a certified Pro Tools training center.

Products and Developers Learn about Avid products; download demo software or learn about our Development Partners and their plug-ins, applications, and hardware.

News and Events Get the latest news from Avid or sign up for a product demo.

Chapter 2: Controls and Connectors

Front Panel

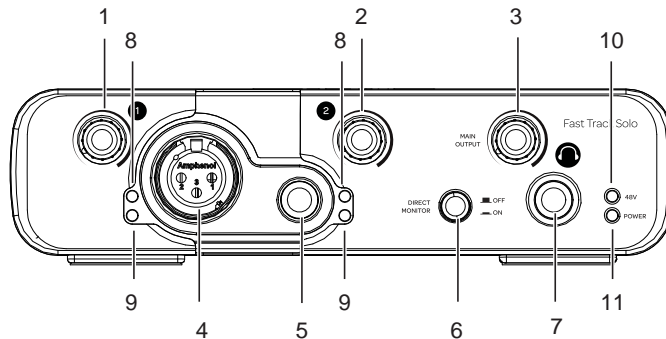

1 – Microphone Input Gain Control

Adjust this knob to control the input gain for the Microphone input when setting recording levels.

2 – Instrument Input Gain Control

Adjust this knob to control the input gain for the Instrument input when setting recording levels.

3 – Output Level Control

Adjust this knob to control the Main and Headphone output level.

4 – Microphone Input

This jack is used for connecting a microphone using a standard XLR cable.

5 – Instrument Input

This jack is used for connecting a 1/4-inch instrument cable.

6 – Direct Monitor Button

This button switches Direct Monitoring on and off, which provides a latency-free mix of the input signal and the output of your music software. When Direct Monitoring is switched off, you must use the monitoring option in your music software.

7 – Headphone Output

Connect your stereo headphones to this 1/4-inch output. Set the volume using the Output Level control.

8 – Clip Indicators

The red LED indicates “clipping” or distortion on the input of the corresponding input channel. If the LED lights, reduce the Input Gain control for the channel.

9 – Signal Indicators

The green LED indicates the presence of an audio signal at the corresponding input. If you are sending signal to the input and the Signal indicator does not light, try increasing the Input Gain control for the channel.

10 – Phantom Power Indicator (48V)

This red LED illuminates when the Phantom Power switch on the back panel is set to the “on” position.

11 – Power Indicator

This green LED indicates that Fast Track Solo is receiving power from the connected host computer. When using Fast Track Solo with an iPad, you will need to power Fast Track Solo using the USB power adapter that was included with your iPad.

Back Panel

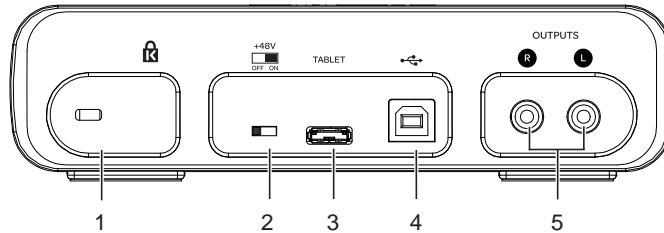

1 – Lock Port

Use this port to secure Fast Track Solo using a Kensington-style security lock.

2 – 48V Phantom Power Switch

When this switch is in the “on” position, 48V phantom power is sent to the front microphone panel input. Enable phantom power for condenser microphones that require external power. The Phantom Power Indicator LED illuminates when phantom power is on.

⚠ *Although phantom power can be used safely with most microphones, it is possible to damage some ribbon microphones. Always turn off phantom power and wait at least ten seconds before connecting a ribbon microphone.*

Refer to the documentation for your microphone for more information about its power requirements.

3 – Tablet Port

This port is used for connecting Fast Track Solo to an iPad.

4 – USB Port

This port is used for connecting Fast Track Solo to your host computer, using the supplied USB cable. If you are using Fast Track Solo with an iPad, use this port to connect a USB power adapter.

5 – Line Outputs

Use this stereo pair of RCA jacks to connect Fast Track Solo to either a pair of powered studio monitors, a mixer, or stereo amplifier. The level for these outputs is controlled by the Output Level control on the front panel.

Chapter 3: Installing Drivers and Making Connections

Installing Fast Track Solo Drivers

Mac OS X

Fast Track Solo is a class-compliant device for Mac OS X, so no drivers are required.

iOS

Fast Track Solo is an iOS-compliant device for iPad, so no drivers are required.

Windows

 *Do not start this procedure with your Fast Track Solo connected to your computer.*

To install the Fast Track Solo driver:

- 1 Ensure that Fast Track Solo is *not* connected to your computer.
- 2 Download the Fast Track Solo driver from www.avid.com/drivers.
- 3 Locate and double-click Install Avid Fast Track Solo.exe.
- 4 Follow the on-screen instructions.

 *You may be notified that the driver being installed has not passed Windows Logo testing, or asked whether the program you wish to run is a trusted application. Click “Install.”*

- 5 Once the installation is complete and your computer has been restarted, connect Fast Track Solo to any available USB port on your computer.
- 6 When the Found New Hardware Wizard dialog appears, select “Install the software automatically” and click “Next.”
- 7 Click “Finish” once the software has been installed.

Hardware Connections

Connecting Fast Track Solo to a Computer

Once you have installed the driver (Windows only), connect Fast Track Solo to any available USB port on your computer. Fast Track Solo is powered over the USB bus from your computer.

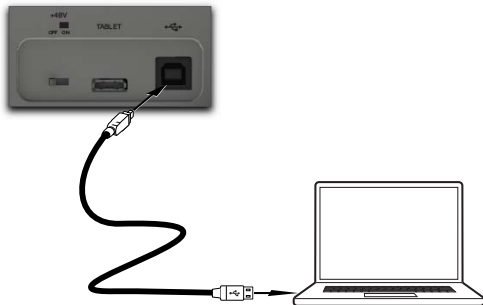

⚠ *Fast Track Solo supports USB 1.1 or higher. However, on computers running Windows 7, be sure to connect Fast Track Solo to a USB 2 port. USB 3 is not currently supported with Fast Track Solo on Windows 7.*

Connecting Fast Track Solo to an iPad

Connect your iPad to the Tablet port on the back panel of Fast Track Solo.



When using Fast Track Solo with an iPad, you will need to power Fast Track Solo using the USB power adapter that was included with your iPad (or with a USB power adapter purchased separately).

Connecting a Microphone

Connect a microphone to the Microphone input on the front panel of Fast Track Solo using a standard XLR microphone cable. If you are connecting a microphone that requires phantom power, be sure to enable the 48V switch on the back panel of Fast Track Solo.

Connecting an Instrument

Connect an instrument (such as an electric guitar or bass) to the Instrument input using a standard 1/4-inch instrument cable.

Connecting Headphones

Connect stereo headphones to the 1/4-inch TRS Headphone output on the front panel.

Connecting Speakers

Connect the Line Output jacks on the back panel of Fast Track Solo to the inputs of a mixer, stereo power amplifier, or powered studio monitors using RCA cables (note that RCA to 1/4-inch or XLR adapters may be required).

⚠ *When connecting speakers, make sure that the speakers are powered off. Turn your speakers on only after you have connected Fast Track Solo to a host computer or iPad and Fast Track Solo is fully powered on.*

Chapter 4: Using Fast Track Solo

Setting the Output Level

Once the Fast Track Solo Line Outputs have been connected to a mixer, amplifier or powered monitors, the overall output volume is controlled by the Output Level control on the front panel.

⚠ *Be sure to turn down all monitoring levels before powering on your Fast Track Solo and using it with headphones or loudspeakers.*

Recording Microphones

Connect a microphone using a standard XLR microphone cable to the front panel XLR input.

If you are using a microphone that requires phantom power, activate the back panel 48V Phantom Power switch after connecting a microphone to the front panel input.

⚠ *Although phantom power can be used safely with most microphones, it is possible to damage some ribbon microphones. Always turn off phantom power and wait at least ten seconds before connecting a ribbon microphone.*

Refer to the documentation for your microphone for more information about its power requirements.

In your audio software, select the appropriate Fast Track Solo input (1) as the source for the track you will be recording to. Adjust the Input Gain control until you have sufficient audio signal without clipping.

Recording Instruments

Connect an electric guitar, bass, or other instrument using a standard 1/4-inch instrument cable.

In your audio software, select the appropriate Fast Track Solo input (2) as the source for the track you will be recording to. Adjust the Input Gain control until you have sufficient audio signal without clipping.

Setting Recording Levels

To set the gain levels for an input channel, turn the corresponding Input Gain control fully counter-clockwise. While the sound source is playing at its loudest levels, slowly turn the knob clockwise until the green LED of the Signal Indicator for the channel begins to illuminate. Adjust the control so that the green Signal indicator remains lit, but so that the red Clip indicator does not light. At this point, you should be ready to record with the optimum gain setting.

Direct Monitoring

When recording an audio signal into your audio software, there is often a slight delay before it reaches the outputs of the software and Fast Track Solo. This delay, called *latency*, is caused by the computer processing required to convert and record audio. Since this delay can be distracting, Fast Track Solo provides a direct monitoring path from the inputs to the outputs, which is activated by pressing the Direct Monitor button.

When Direct Monitoring is enabled, the input signal is mixed with the output signal from your audio software, and routed directly to the Line and Headphone outputs. This lets you hear the “live” inputs without latency.

The Direct Monitor button has no effect on what is being recorded by your software. When using the Direct Monitor feature, make sure any software monitoring option for direct (or “low latency”) monitoring is disabled. Disabling Low Latency monitoring prevents “double-monitoring” of input audio signals when using the Direct Monitoring feature.

When “double-monitoring” occurs, there will be an increase in volume and an undesirable “phasing” sound. For more details about its monitoring function, refer to the documentation for your audio software.

Sample Rate, Bit Depth, and Buffer Size

Fast Track Solo can operate at two sample rates (44.1 kHz or 48 kHz) and two different bit depths (16 bit or 24 bit) to accommodate a variety of projects. You should decide on a sample rate and bit depth for your project before recording, to maximize fidelity and avoid time-consuming format conversions.

Choosing Sample Rate and Bit Depth

The following guidelines should help you choose appropriate sample rate and bit depth settings for your recording:

Music Projects

If the final mix will be played back on CD, or in MP3 format, a 24-bit resolution with a sample rate of 44.1 kHz is recommended.

 *The final output file will have to be converted to 16 bit/44.1 kHz for playback on CD and some audio player applications.*

Video Projects

If the final mix is intended for DVD, film or TV, a 24-bit resolution with a sample rate of 48 kHz is recommended.

 *It is not possible to raise the fidelity of previously recorded audio by increasing its bit depth or sample rate.*

Always use the highest possible settings that are appropriate for your project.

Choosing a Buffer Size

Use the lowest possible buffer size to minimize latency while recording. However, you may want to increase the buffer size for larger mixes with lots of plug-ins to avoid pops and clicks in the audio output.

Configuring Settings

Mac OS X

On Mac OS X, use the Audio MIDI Setup application, or your audio application preferences or settings, to configure the device sample rate, hardware buffer size, and bit depth.

iOS

On iOS, use the system preferences for your audio app to configure the device sample rate, hardware buffer size, and bit depth.

Windows

On Windows, use the Avid Fast Track Solo control panel to configure the Sample Rate setting and Buffer Size for the device.

To configure the Fast Track control panel:

- 1 Choose Start > Control Panel > Fast Track Solo.
- 2 Select the sample rate (44100 or 48000) from the Sample Rate pop-up menu.
- 3 Set the buffer size with the Preferred Buffer Size slider.

Appendix A: Compliance Information

Environmental Compliance

Disposal of Waste Equipment by Users in the European Union



This symbol on the product or its packaging indicates that this product must not be disposed of with other waste. Instead, it is your responsibility to dispose of your waste equipment by handing it over to a designated collection point for the recycling of waste electrical and electronic equipment. The separate collection and recycling of your waste equipment at the time of disposal will help conserve natural resources and ensure that it is recycled in a manner that protects human health and the environment. For more information about where you can drop off your waste equipment for recycling, please contact your local city recycling office or the dealer from whom you purchased the product.

Proposition 65 Warning

⚠ *This product contains chemicals, including lead, known to the State of California to cause cancer and birth defects or other reproductive harm. Wash hands after handling.*

Perchlorate Notice

This product may contain a lithium coin battery. The State of California requires the following disclosure statement: "Perchlorate Material – special handling may apply, See www.dtsc.ca.gov/hazardouswaste/perchlorate."

Recycling Notice



EMC (Electromagnetic Compliance)

Avid declares that this product complies with the following standards regulating emissions and immunity:

- FCC Part 15 Class B
- EN 55022 Class B
- EN 55024 Class B
- AS/NZS CISPR 22 Class B
- CISPR 22 Class B

FCC Compliance for United States

Radio and Television Interference

This equipment has been tested and found to comply with the limits for a Class B digital device, pursuant to Part 15 of the FCC Rules.

Communication Statement

NOTE: This equipment has been tested and found to comply with the limits for a Class B digital device, pursuant to Part 15 of the FCC Rules. These limits are designed to provide reasonable protection against harmful interference in a residential installation. This equipment generates, uses, and can radiate radio frequency energy and, if not installed and used in accordance with the instructions, may cause harmful interference to radio communications. However, there is no guarantee that interference will not occur in a particular installation. If this equipment does cause harmful interference to radio or television reception, which can be determined by turning the equipment off and on, the user is encouraged to try and correct the interference by one or more of the following measures:

- Reorient or locate the receiving antenna.
- Increase the separation between the equipment and receiver.
- Connect the equipment into an outlet on a circuit different from that to which the receiver is connected.
- Consult the dealer or an experienced radio/TV technician for help.

Any modifications to the unit, unless expressly approved by Avid, could void the user's authority to operate the equipment.

Australia and New Zealand EMC Regulations



Canadian Compliance

This Class B digital apparatus meets all requirements of the Canadian Interference-Causing Equipment Regulations.

Cet appareil numérique de la classe B respecte toutes les exigences du Règlement sur le matériel brouilleur du Canada.

CE Compliance

(EMC, Safety, and RoHS)



Avid is authorized to apply the CE (Conformité Européenne) mark on this compliant equipment thereby declaring conformity to EMC Directive 2004/108/EC, Low Voltage Directive 2006/95/EC, and RoHS Directive 2011/65/EU (Recast)..

Japan VCCI Compliance

この装置は、クラスB情報技術装置です。この装置は、家庭環境で使用することを目的としていますが、この装置がラジオやテレビジョン受信機に近接して使用されると、受信障害を引き起こすことがあります。取扱説明書に従って正しい取り扱いをして下さい。 VCCI-B

Korean EMC Regulations

이 기기는 가정용(B급) 전자파적합기기로서 주로 가정에서 사용하는 것을 목적으로 하며, 모든 지역에서 사용할 수 있습니다.

Safety Compliance

This equipment has been tested to comply with USA and Canadian safety certification in accordance with the specifications of UL Standards: UL 60950-1, 2nd Edition/IEC 60950-1, 2nd Edition and Canadian CAN/CSA C22.2 No. 60950-1-07, 2007, 2nd Edition. Avid Technology Inc. has been authorized to apply the appropriate NRTL mark on its compliant equipment.

Warning



Important Safety Instructions

- 1) Read these instructions.
- 2) Keep these instructions.
- 3) Heed all warnings.
- 4) Follow all instructions.
- 5) Do not use this equipment near water.
- 6) Clean only with dry cloth.
- 7) Do not block any ventilation openings. Install in accordance with the manufacturer's instructions.
- 8) Do not install near any heat sources such as radiators, heat registers, stoves, or other equipment (including amplifiers) that produce heat.
- 9) Do not defeat the safety purpose of the polarized or grounding-type plug. A polarized plug has two blades with one wider than the other. A grounding type plug has two blades and a third grounding prong. The wide blade or the third prong are provided for your safety. If the provided plug does not fit into your outlet, consult an electrician for replacement of the obsolete outlet.
- 10) Protect power cords from being walked on or pinched particularly at plugs, convenience receptacles, and the point where they exit from the equipment.

11) Only use attachments/accessories specified by the manufacturer.

12) For products that are not rack-mountable: Use only with a cart, stand, tripod, bracket, or table specified by the manufacturer, or sold with the equipment. When a cart is used, use caution when moving the cart/equipment combination to avoid injury from tip-over.

13) Unplug this equipment during lightning storms or when unused for long periods of time.

14) Refer all servicing to qualified service personnel. Servicing is required when the equipment has been damaged in any way, such as power-supply cord or plug is damaged, liquid has been spilled or objects have fallen into the equipment, the equipment has been exposed to rain or moisture, does not operate normally, or has been dropped.

15) For products that are a Mains powered device: The equipment shall not be exposed to dripping or splashing and no objects filled with liquids (such as vases) shall be placed on the equipment.

Warning! To reduce the risk of fire or electric shock, do not expose this equipment to rain or moisture.

16) For products containing a lithium battery:
CAUTION! Danger of explosion if battery is incorrectly replaced. Replace only with the same or equivalent type.

17) The equipment shall be used at a maximum ambient temperature of 40° C.



Avid
2001 Junipero Serra Boulevard
Daly City, CA 94014-3886 USA

Technical Support (USA)
Visit the Online Support Center at
www.avid.com/support

Product Information
For company and product information,
visit us on the web at www.avid.com