

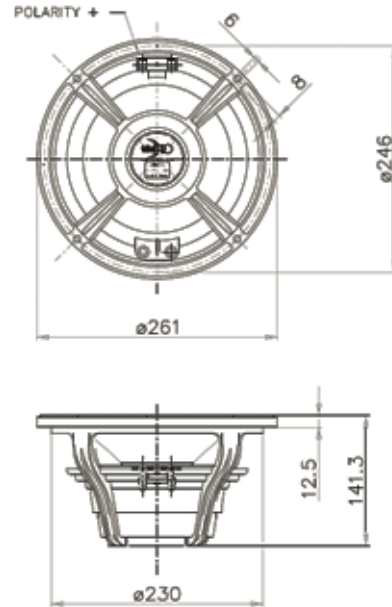

10FH500 Five Hundred Series



NOMINAL SPECIFICATIONS

Nominal Diameter	250 mm (10 in)
Overall Diameter	261 mm (10.28 in)
Bolt Circle Diameter	246 mm (9.69 in)
Baffle Cutout Diameter	232 mm (9.13 in)
Depth	141.3 mm (5.56 in)
Flange and Gasket Thickness	12.5 mm (0.49 in)
Net Weight	3.4 Kg (7.5 lb)
Shipping Box (Single Carton Box)	305x305x185 mm (12x12x7.28 in)
Shipping Weight	4 Kg (8.8 lb)

ELECTRICAL SPECIFICATION

Minimum Impedance	6.4 Ohm
Nominal Impedance	8 Ohm
Nominal Power Handling *	500 W
Maximum Power Handling **	1000 W
Sensitivity (1W/1m)	96 dB
Frequency Range	60÷4000 Hz
Voice Coil Diameter	77 mm (3 in)
Winding Material	Al
Former Material	Glass Fiber
Winding Depth	18 mm (0.71 in)
Magnetic Gap Depth	10.5 mm (0.41 in)
Flux Density	1.2 T

THIELE & SMALL PARAMETERS

Fs	60 Hz
Re	5.1 Ohm
Bl	17.9 N/A
Mms	47 g
Cms	0.15 mm/N
Rms	5.4 Kg/s
Qes	0.28
Qms	3.28
Qts	0.26
Vas	21.6 dm ³ (0.76 ft ³)
Sd	319 cm ² (49.4 in ²)
Xmax ***	7.25 mm
Xdamage ****	12.5 mm
Le	0.85 mH
Mmd	44.8 g
Eta Zero	1.6 %

ORDERING CODES

Push Terminals - 8 Ohm Version	02503924
Faston Terminals - 8 Ohm Version	02503932

NOTES

PATENTED IT2006/000327

(*) 2 Hours Test According to AES 2-1984 Rev. 2003

(**) Maximum power is defined as 3dB greater than nominal power.

(***) Xmax = [(winding depth - magnetic gap depth) / 2] + (magnetic gap depth / 3)

(****) Maximum excursion before permanent damage

CURVES

