

REDNET® 6

REDNET D64R MADI BRIDGE

User Guide

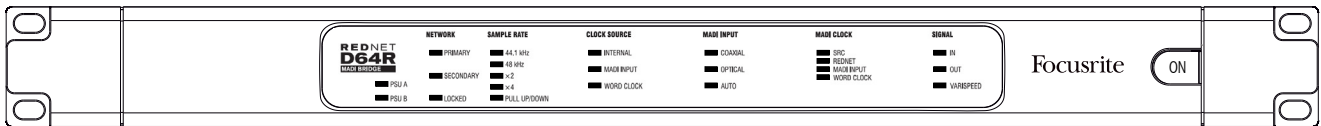
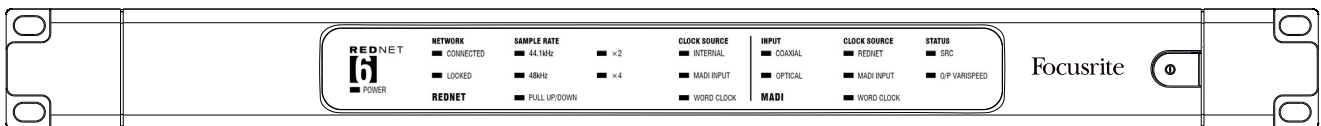

Focusrite®

www.focusrite.com

Version 1.01

FA9096-07

CONTENTS

About this User Guide	3
Box Contents	3
INTRODUCTION	4
INSTALLATION GUIDE	5
RedNet 6 / D64R Connections and Features	5
Front Panels	5
Rear Panels	7
Power Connection	8
IEC Power Cord Retaining Clip	8
Physical Characteristics	9
Power Requirements	9
REDNET 6/D64R OPERATION	10
First Use and Firmware Updates	10
Digital Clocking	10
MADI Modes	11
Pull Up and Pull Down Operation	12
Sample Rate Converters	12
OTHER REDNET SYSTEM COMPONENTS	13
USING REDNET CONTROL	13
Signal Metering	13
ID (Identification)	14
Tools Menu	14
APPENDIX	15
Connector Pinouts	15
Ethernet Connector	15
PERFORMANCE AND SPECIFICATIONS	16
Focusrite RedNet Warranty and Service	19
Registering Your Product	19
Customer Support and Unit Servicing	19
Troubleshooting	19

About this User Guide

This User Guide applies to both the RedNet 6 and RedNet D64R MADI Bridge interfaces. It provides information about installing each unit and how either can be connected into your system.

All references relating to the RedNet 6 are also applicable to the RedNet D64R. In any instances where names or values differ, the screening or value for the D64R unit will be appended in square brackets, eg., "Power [PSU A]".

D64R

Any information that is relevant to only one device will be separated within a border like this.

A RedNet System User Guide is also available from the RedNet product pages of the Focusrite website. The Guide provides a detailed explanation of the RedNet system concept, that will help you achieve a thorough understanding of its capabilities. We recommend that all users, including those already experienced in digital audio networking, take the time to read through the System User Guide so that they are fully aware of all the possibilities that RedNet and its software have to offer.

If either User Guide doesn't provide the information you need for a comprehensive collection of common technical support queries please consult: focusritepro.zendesk.com.

Box Contents

- RedNet 6 [D64R] unit
- 1 [2] x IEC AC mains cables
- 2 x IEC mains cable retaining clips (*See instructions on page 8*)
- 2m Cat 6 Ethernet cable *D64R only*
- Safety information cut sheet *RedNet 6 only*
- RedNet Getting Started Guide
- Product registration card, provides links to:
 - RedNet Control
 - RedNet PCIe drivers (included with RedNet Control download)
 - Audinate Dante Controller (installed with RedNet Control)
 - Dante Virtual Soundcard (DVS) Token and download instructions

INTRODUCTION

Thank you for purchasing the Focusrite RedNet 6/D64R.



RedNet 6/D64R MADI Bridge is a 1U 19in rack-mount unit that provides an interface between any MADI (AES10) device and the RedNet Ethernet audio system.

Support for up to 64 channels of digital audio I/O at standard sample rates (44.1/48kHz) from a MADI system – 32 channels at 96kHz and 16 at 192kHz.

D64R

Dual Ethernet connectors (primary and secondary) on the rear-panel allow maximum network reliability with seamless switchover to a standby network in the unlikely event of a network failure. These ports may also be used to daisy-chain additional units when operating in Switched mode.

Redundant power supplies (PSU A and B) with separate input sockets on the rear panel allow one supply to be connected to an uninterruptible source. Each PSU's status can be monitored remotely over the network or from the front panel.

The MADI connection can use both BNC coax and standard duplex fibre interfaces.

A Sample Rate Converter (SRC) on each input and output allows instant operation with any MADI source irrespective of the sample rate or clocking of the Dante audio network.

Word Clock I/O on BNC connectors allows synchronisation of the Dante network or the MADI stream to house clock, plus syncing external equipment to the Dante network.

The front panel contains a set of LEDs to confirm network status, sample rate, clock sources and MADI interface settings.

INSTALLATION GUIDE

RedNet 6/D64R Connections and Features

Front Panels

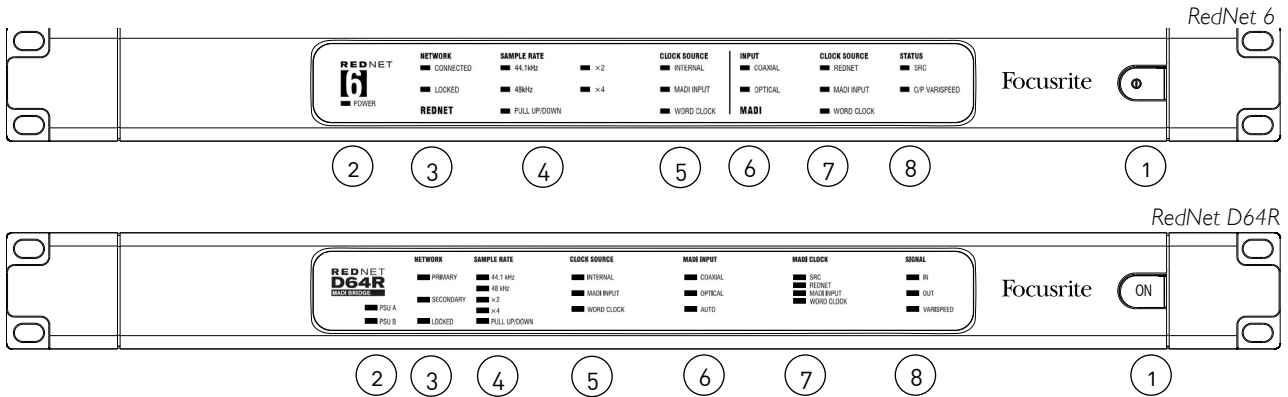

1. AC Power Switch

2. Power Indicator(s)

- **Power [PSU A]** – Illuminates when an AC input is applied and all DC outputs are present.

D64R

- **PSU B** – Illuminates when an AC input is applied and all DC outputs are present.

When both supplies are functioning and have AC inputs PSU A will be the default supply.

3. RedNet Network Status Indicators:

- **CONNECTED [PRIMARY]** – Illuminates when the device is connected to an active Ethernet network. [Also illuminates to indicate network activity when operating in Switched mode.]

D64R

- **SECONDARY** – Illuminates when the device is connected to an active Ethernet network. Not used when operating in Switched mode.

- **LOCKED** – Illuminates when a valid sync signal is received from the network, or when the RedNet 6/D64R unit is Network Leader. Flashes if external clock is selected but not connected.

4. RedNet Sample Rate Indicators

Five orange indicators: **44.1 kHz**, **48 kHz**, **x2** (multiple of 44.1 or 48), **x4** (multiple of 44.1 or 48) and sample rate **PULL UP/DOWN**. These Indicators illuminate individually or in combination to indicate the sample rate being used. For example, for a 96kHz Pull Up/Down setting, the 48kHz, x2 and Pull Up/Down indicators will illuminate.

5. RedNet Clock Source Indicators

When RedNet 6/D64R is the clock leader of the Dante network, one of the following indicators will illuminate:

- **INTERNAL** – Orange LED, indicates that unit is locked to its internal clock.
- **MADI INPUT** – Orange LED, indicates that unit is locking to MADI input.
- **WORD CLOCK** – Orange LED, illuminates to indicate an external Word Clock sync is in use.

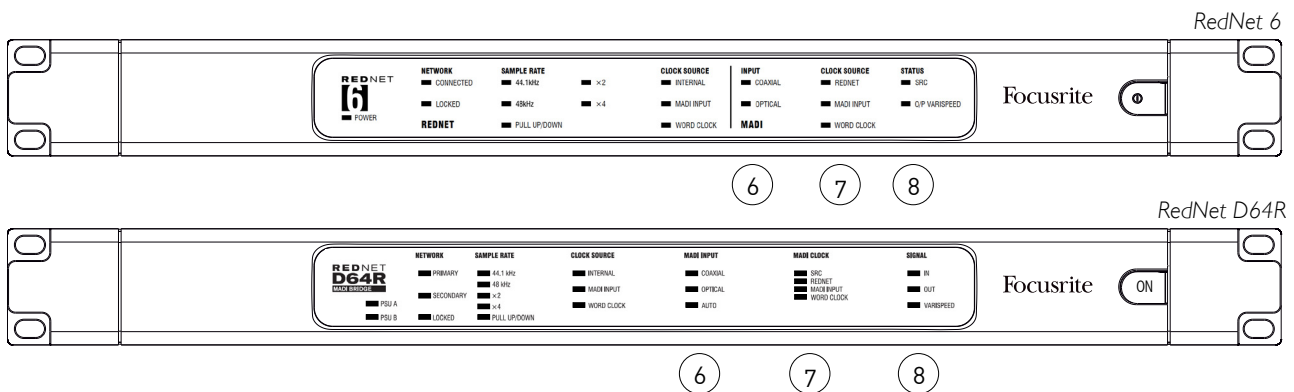

6. MADI Input Indicators

If a selected input signal is either invalid or not present the input source LED will flash.

- **COAXIAL** – Orange LED, indicates that Coax is the selected input, or that AUTO is selected and the BNC input is valid.
- **OPTICAL** – Orange LED, indicates that Optical is the selected input, or that AUTO is selected and the Optical input is valid.

D64R • **AUTO** – Indicates that input selection is automatically set (Optical preferred). This LED will flash if Auto is selected but neither input (COAX or Optical) is valid.

7. Clock Source [MADI Clock]

D64R

- **SRC** – Orange LED, indicates that SRC is currently active.
- **REDNET** – Orange LED, indicates that MADI signal is using the network clock.
- **MADI INPUT** – Orange LED, indicates that MADI output clock is locked to the input rate.
- **WORD CLOCK** – Orange LED, indicates that MADI input/output is locked to the incoming word clock signal on rear panel BNC.

8. MADI Status [Signal]

RedNet 6 • **SRC** – Orange LED, indicates that SRC is currently active.

D64R

- **INPUT** – Green LED, indicates a signal present at the selected MADI input. The LED will light if any of the channels in the input stream has a value of -42dB(fs) or higher.
- **OUTPUT** – Green LED, indicates a signal present at the selected MADI output. Illuminates as for Input signal.
- **O/P VARISPEED [VARISPEED]** – Orange LED, indicates that the unit is running in 56-channel MADI mode. This LED will flash when either:
 - a) the signal is out of MADI tolerance (beyond 1% of nominal) and the unit is NOT in 56-channel mode, or...
 - b) if 'MADI follow Rx' is set and an invalid input is detected.

Rear Panels

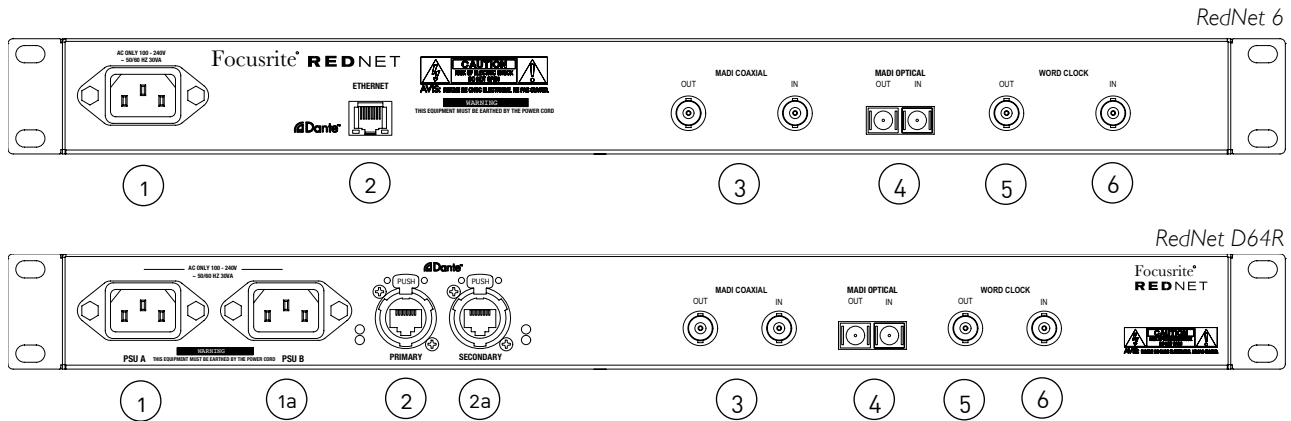

1. IEC Mains Inlet [PSU A]

Standard IEC receptacle for connection of AC mains. RedNet 6/D64Rs feature 'Universal' PSUs, enabling them to operate on any supply voltage of between 100 V and 240 V.

Note that initial use requires fitment of the plug retaining clip – see page 8.

1a IEC Mains Inlet B

D64R

Input connector for backup mains power source. Power supply B remains on standby but will seamlessly take over if PSU A develops a fault or loses its mains input supply.

If an uninterruptible supply (UPS) is available, it is recommended that this is applied to input B.

2. Network Port [Primary]

RJ45 [etherCON] connection for the Dante network. Use standard Cat 5e or Cat 6 network cables to connect to a local Ethernet switch to connect the RedNet 6/D64R to the RedNet network. Adjacent to each network socket are LEDs which illuminate to indicate a valid network connection plus network activity. *See page 15 for connector details.*

2a Secondary Network Port

D64R

Secondary Dante network connection where two independent Ethernet links are being used (Redundant mode) or an additional port on an integral network switch on the primary network (Switched mode).

3. MADI I/O – BNC Coax

Input and output BNC connectors for 75Ω coaxial cable.

4. MADI I/O – Optical

Duplex SC optical connector. Fibre standard is 62.5/125 Multimode.

5. Word Clock Out

Provides an output of the chosen system clock reference (can be switched between base rate or network rate).

6. Word Clock In

Allows synchronisation of the Dante network to house word clock.

Power Connection

This information is only applicable to the RedNet D64R.

IEC Power Cord Retaining Clip

RedNet D64R is supplied with IEC power cord retaining clips. These prevent accidental disconnection of a power cord during use. When the unit is first installed, the retaining clips will need to be attached to power input sockets on the rear panel.

Insert each clip by squeezing together the legs as shown in the first image below, aligning the pins with the through-holes on the IEC fixing posts one at a time, and then releasing.

Ensure that the orientation of each clip is as shown in the other images below or the effectiveness will be compromised.

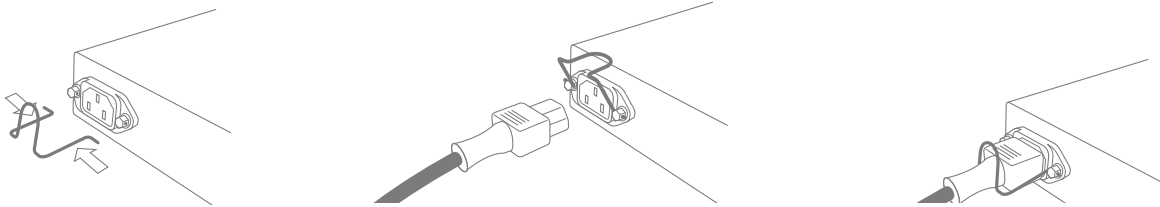

Physical Characteristics

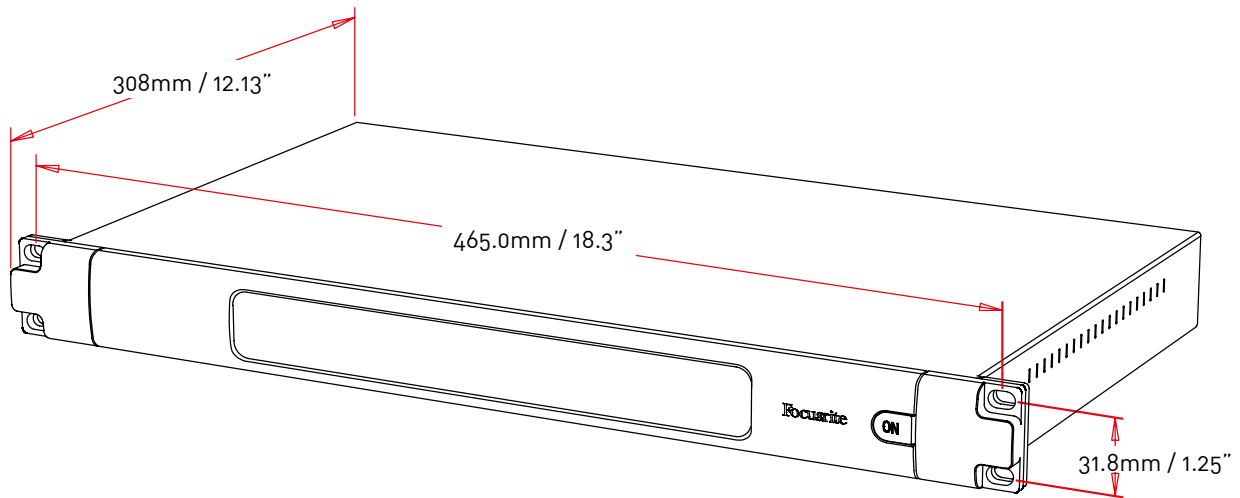

RedNet 6/D64R dimensions are illustrated in the diagram above.

RedNet 6/D64R requires 1U of vertical rack space and at least 350 mm of rack depth, to allow for cables. RedNet 6/D64R weighs 3.74 (4.32) kg and for installations in a fixed environment (eg., a studio), the front-panel mounting screws will provide adequate support. If the units are to be used in a mobile situation (eg., flight-cased for touring, etc.), consideration should be given to using side support rails within the rack.

RedNet 6/D64R generates little significant heat and is cooled by natural convection. The ambient operating temperature of the device is 50 degrees Celcius.

Ventilation is via slots in the enclosure at both sides. Do not mount RedNet 6/D64R immediately above any other equipment which generates significant heat, for example, a power amplifier. Also, ensure that when mounted in a rack, the side vents are not obstructed.

Power Requirements

RedNet 6/D64R is mains-powered. It incorporates 'Universal' power supplies, which can operate on any AC mains voltage from 100 V to 240 V. The AC connections are made via a standard 3-pin IEC connectors on the rear panel.

D64R

When PSU A & PSU B are both connected, PSU A becomes the default supply and therefore draws more current than B. If a backup mains supply is provided from an uninterruptible source, it is recommended that this is connected to input B.

One or two mating IEC cables are supplied with the unit – these should be terminated with mains plugs of the correct type for your country.

The AC power consumption of the RedNet 6/D64R is 30VA.

Please note that there are no fuses in RedNet 6/D64R, or other user-replaceable components of any type. Please refer all servicing issues to the Customer Support Team [see "Customer Support and Unit Servicing" on page 19].

REDNET 6/D64R OPERATION

First Use and Firmware Updates

Your RedNet 6/D64R may require a firmware update* when it is first installed and switched on. Firmware updates are initiated and handled automatically by the RedNet Control application.

**It is important that the firmware update procedure is not interrupted – either by switching off power to the RedNet 6/D64R unit or the computer on which RedNet Control is running, or by disconnecting either from the network.*

From time to time Focusrite will release RedNet firmware updates within new versions of RedNet Control. We recommend keeping all RedNet units up to date with the latest firmware version supplied with each new version of RedNet Control.

Digital Clocking

RedNet 6/D64R is able to operate across two separate clock domains:

- The RedNet network clock
- The MADI audio clock

It is not necessary for these two domains to be synchronous so independent clock sources can be used. This is made possible by the use of sample rate converters in the product's audio input/output.

Three possible RedNet clock sources are available under 'RedNet Clock Source' in the RedNet Control application:

- Internal: Select to clock to the network via Cat 5e or Cat 6 cable (RedNet 6/D64R can also act as network leader clock).
- Word Clock Input: Select to clock to an external word clock via BNC.
- MADI Input: Select to clock to the MADI device via Optical or Coaxial MADI.

When sample rate conversion is enabled, the clock source of the MADI output and the RedNet 6/D64R can be selected independently in the RedNet Control application under 'Sample Rate Convertors'.

When sample rate conversion is disabled, the MADI output will be synchronous with the RedNet network. In this case, the selection of clock source for the unit is made under 'RedNet Clock Source'. If MADI and the Network are to run synchronously, the following rules must be followed:

- With Internal as the clock source, it is important that any device sending a MADI signal to RedNet 6/D64R is also receiving a word clock signal from the RedNet 6/D64R or another RedNet unit.
- With Word Clock In as the clock source, any device which is sending a MADI signal to RedNet 6/D64R must also receive a valid clock signal from the same source as RedNet 6/ D64R.

The RedNet 6/D64R Word Clock Output may be switched via the RedNet Control application to output one of four clock signals under 'Word Clock Output':

- Network Clock: Select to output the same sample rate as the network.
- Network Clock (Base Rate): Select to output the base rate of the network.
- Word Clock Input: Select to output the same clock as the Word Clock Input. (Note: Switchable 75 ohm termination can be selected via RedNet Control.)
- MADI Input: Select to output the same clock as the MADI Input clock.

MADI Modes

RedNet 6/D64R supports both varispeed and non-varispeed MADI modes. Non-varispeed mode enables up to 64 channels I/O at 48 kHz. Varispeed mode enables up to 56 channels I/O at 48kHz. The MADI input of RedNet 6/D64R will automatically detect the channel count of incoming signals, meaning the user does not need to adjust any settings. When 'Follow Rx' (as described below) is set, the MADI output of RedNet 6/D64R will automatically be set to match the incoming MADI signal.

The RedNet 6/D64R MADI input select is auto-sensing by default, although manual override is provided in the RedNet Control application. When Auto mode is selected and both coaxial and optical inputs are present, RedNet 6/D64R will automatically prefer the optical input. If the optical cable is removed from the RedNet 6/D64R input, the unit will automatically switch to the coaxial input. If Auto Input is selected while no valid coaxial or optical input is present, both the optical and coaxial input indicators will flash.

The RedNet 6/D64R MADI output has three varispeed states selectable from the RedNet 6/D64R spanner menu in the RedNet Control application under 'MADI Output Varispeed':

- Follow Rx: Select to match the channel count of the incoming MADI signal.
- Fixed (64/32/16): Select to specify 64, 32 or 16 channels depending on the sample rate.
- Varispeed (56/28/14): Select to specify 56, 28 or 14 channels depending on the sample rate.

In addition to the varispeed states the RedNet 6/D64R MADI output is capable of a range of sample rates. These can be selected in the RedNet Control application under 'Sample Rate Convertors ↑ MADI Rate':

- Follow Rx (Rate & Varispeed): Select when a MADI input is present, the MADI output of RedNet 6/D64R will automatically match the MADI input for Sample Rate (Rate) and channel count (Varispeed).
- Single (64/56): Select to output 44.1 or 48kHz
- Dual (32/28): Select to output 88.2 or 96kHz
- Quad (16/14): Select to output 176.4 or 192kHz

Pull Up and Pull Down Operation

RedNet 6/D64R is able to operate at a specified pull up or pull down percentage as selected in the Dante Controller application.

When operating in 64-channel (ie. non-varispeed) mode, MAD I is not capable of operating at greater than approximately $\pm 1\%$ of the nominal sample rate. This may become a problem when the network clock domain is pulled up beyond 1% of nominal. In this condition, the Output Varispeed indicator on the front panel will flash to indicate that the output is out of MAD I tolerance. Therefore, to continue generating a valid RedNet 6/D64R MAD I output, it would be necessary to operate the MAD I output in 56-channel (varispeed) mode, use sample rate conversion or reduce the network rate to within 1% of nominal sample rate.

Sample Rate Converters

Sample Rate Conversion will need to be switched in for any sources that are not using the current system clock as a reference signal. This can be enabled in the RedNet Control application under the 'Sample Rate Converter' menu.

This can be particularly useful in post-production environments where the network audio is pulled up or down, but it is necessary to have the MAD I stream run at a base sample rate to interface – for example – with a mixing console.

Note that engaging the sample rate converters will increase the overall latency of the device.

OTHER REDNET SYSTEM COMPONENTS

The RedNet hardware range includes various types of I/O interface and PCIe/ PCIeR digital audio interface cards which are installed in the system’s host computer or in a chassis. All the I/O units can be considered as “Break-Out” (and/or “Break-In”) boxes to/from the network, and all are built in mains-powered, 19” rackmount housings, unless otherwise stated. There are also three software items, RedNet Control (see below), Dante Controller and Dante Virtual Soundcard.

USING REDNET CONTROL

RedNet Control will reflect the status of the RedNet units present in the system, presenting an image representing each hardware unit.



The illustration above shows a RedNet 6, with signal present on every channel and a locked network connection with SRC’s turned off.

D64R

		PSUs A & B – Each illuminates if PSU has power input and all DC outputs are present.
		Network[s] – Each illuminates if a valid connection is present.
		Locked – Unit is successfully locked to the network (changes to the red cross if not locked).
		Network Leader – Illuminated indicating that unit is the network leader.
		External Clock – Green: Illuminates when external clock is selected and locked. Amber: Illuminates when external clock is selected but not locked. Red: Illuminates when external clock is selected but not connected.

Signal Metering

Each input and output channel has a virtual signal indicator. Five different states are represented:

- Black: No signal present
- Dim green: > -126 dBFS
- Green: -42 dBFS
- Amber: -6 dBFS
- Red: 0 dBFS
- SRC: Indicates sample rate converters are active.

ID (Identification)

Clicking on the ID icon  will identify the physical device being controlled by flashing its front panel LEDs.

Tools Menu

Clicking on the Tools icon  will gain access to the following system settings:

MADI Input Select – Only one can be selected at any time.

- Auto
- Coaxial
- Optical

MADI Output Varispeed – Only one can be selected at any time.

- Follow Rx (Rate & Varispeed)
- Fixed {64/32/16}
- Varispeed {56/28/14}

Preferred Leader – On/Off state.

RedNet Clock Source – Only one can be selected at any time.

- Internal (RedNet 6/D64R is network leader but running from internal clock)
- Word Clock Input
- MADI Input

Word Clock Input Termination – Tick option On/Off. (Terminates word clock input BNC with 75Ω.)

Word Clock Output – Only one can be selected at any time.

- Network
- Network (Base Rate)
- Word Clock Input
- MADI Input

Sample Rate Convertors

- Enable – Tick option On/Off
- MADI Output Rate – Only one can be selected at any time.
 - Follow Rx (Rate & Varispeed)
 - Single Rate {64/56}
 - Double Rate {32/28}
 - Quad Rate {16/14}
- SRC Clock Source – Only one can be selected at any time.
 - RedNet
 - Word Clock Input
 - MADI Input

APPENDIX

Connector Pinouts

Ethernet Connector

Connector type: RJ-45 [etherCON] receptacle
Applies to: Ethernet (Dante)

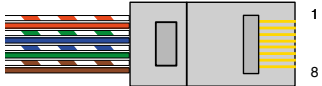

Pin	Cat 6 Core
1	White + Orange
2	Orange
3	White + Green
4	Blue
5	White + Blue
6	Green
7	White + Brown
8	Brown

PERFORMANCE AND SPECIFICATIONS

Sample Rate Converters	
Sample Rate Lock Range	41 to 216 kHz (MADI)
Gain Error	-0.01 dB
Dynamic Range	> 139 dB [-60 dBFS method]
THD + N	< -130 dB (0.00003%); 0 dBFS input
Latency	43 to 196 samples (Network and MADI sample rate dependent)
MADI Clock Sources	RedNet, MADI Input and Word Clock

Digital Performance	
Supported Sample Rates	44.1 / 48 / 88.2 / 96 / 176.4 / 192 kHz [-4% / -0.1% / +0.1% / +4.167%] at 24 bit
Clock Sources	Internal, MADI or from Dante Network Leader
Ext. Word Clock Range	Nominal sample rate $\pm 7.5\%$

Rear Panel Connectivity	
MADI Coaxial	
Electrical Standard	As per AES10:2008
Recommended Cable	75 Ω characteristic impedance
Connector	BNC 75 Ω
MADI Optical	
Optical Standard	As per AES10:2008 (ISO/IEC 9314-3, FDDI, ANSI X3.166)
Recommended Cable	(OM1) Multi-mode, Graded-index, 62.5 μ m core, 125 μ m cladding (OM2) Multi-mode, Graded-index, 50 μ m core, 125 μ m cladding OM1 adheres to AES10:2008 RedNet 6/D64R supports OM2 if 3rd Party Device also supports OM2.
Connector	Duplex SC
Word Clock	
Input	1 x BNC 75 Ω port (switchable termination)
Output	1 x BNC 75 Ω port
PSU & Network	
PSU	1 [2] x IEC Inputs with retaining clips
Network	1 x RJ45 [2 x etherCON NE8FBH-S, also compatible with standard RJ45 connectors (Accommodates rugged etherCON NE8MC*. Does not intermate with Cat 6 cable connector NE8MC6-MO and NKE65* cable)]

Front Panel Indicators	
Power [PSU A]	Green LED. Illuminates when an AC input is applied and all DC outputs are present
PSU B [D64R only]	Green LED. Illuminates when an AC input is applied and all DC outputs are present
Network Connected [Primary]	Green LED. Indicates that a network connection is present [on Primary port when in Redundant mode. When in Switched mode, a valid network connection at either Primary or Secondary network port will cause this LED to illuminate]
Network Secondary [D64R only]	Green LED. Indicates that a network connection is present on secondary port when in redundant mode. Not used in switched mode
Network Locked	Green LED. When unit is network follower, shows valid network lock. When unit is network leader, shows lock to indicated clock source. Flashing indicates external clock is selected but not connected
Sample Rate	Orange LED for each: 44.1 kHz, 48 kHz, x2, x4
Pull Up/Down	Indicates unit is set to operate on a Dante pull up/down domain
RedNet Clock Source	Orange LED for each: Internal, MADI Input and Word Clock
MADI Input	Orange LED for each: Coaxial, Optical [and Auto]
MADI Clock Source	Orange LED for each: [SRC], RedNet, MADI Input and Word Clock
MADI Status [RedNet 6]	Orange LED for each: SRC & O/P Varispeed
Signal [D64R only]	2 Green LEDs: 1 input/1 output. Illuminate at -126 dBFS. Orange LED: Varispeed

Network Modes [D64R Only]	
Redundant	Allows unit to connect to two independent networks
Switched	Connects both ports to integrated network switch allowing daisy-chaining of device

Channel Count			
MADI Clock	Rednet Clock:		
	Single	Double	Quad
Single	64	32	16
Single – Varispeed	56	32	16
Double	32	32	16
Double – Varispeed	28	28	16
Quad	16	16	16
Quad – Varispeed	14	14	14

Dimensions	
Height	44.5mm / 1.75" (1RU)
Width	482.6mm / 19"
Depth	308mm / 12.13"

Weight	
Weight	3.74 [4.32] kg

Power	
PSU[s]	1 [2] x Internal, 100-240V, 50/60Hz, consumption 30W

Focusrite RedNet Warranty and Service

All Focusrite products are built to the highest standards and should provide reliable performance for many years, subject to reasonable care, use, transportation and storage.

Very many of the products returned under warranty are found not to exhibit any fault at all. To avoid unnecessary inconvenience to you in terms of returning the product please contact Focusrite support.

In the event of a Manufacturing Defect becoming evident in a product within 12 months from the date of the original purchase Focusrite will ensure that the product is repaired or replaced free of charge.

A Manufacturing Defect is defined as a defect in the performance of the product as described and published by Focusrite. A Manufacturing Defect does not include damage caused by post-purchase transportation, storage or careless handling, nor damage caused by misuse.

Whilst this warranty is provided by Focusrite the warranty obligations are fulfilled by the distributor responsible for the country in which you purchased the product.

In the event that you need to contact the distributor regarding a warranty issue, or an out-of-warranty chargeable repair, please visit: pro.focusrite.com/rest-of-the-world

The distributor will then advise you of the appropriate procedure for resolving the warranty issue. In every case it will be necessary to provide a copy of the original invoice or store receipt to the distributor. In the event that you are unable to provide proof of purchase directly then you should contact the reseller from whom you purchased the product and attempt to obtain proof of purchase from them.

Please do note that if you purchase a Focusrite product outside your country of residence or business you will not be entitled to ask your local Focusrite distributor to honour this limited warranty, although you may request an out-of-warranty chargeable repair.

This limited warranty is offered solely to products purchased from an Authorised Focusrite Reseller (defined as a reseller which has purchased the product directly from Focusrite Audio Engineering Limited in the UK, or one of its Authorised Distributors outside the UK). This Warranty is in addition to your statutory rights in the country of purchase.

Registering Your Product

For access to Dante Virtual Soundcard, please register your product at: www.focusrite.com/register

Customer Support and Unit Servicing

You can contact our dedicated RedNet Customer Support team free of charge:

Email: rednetsupport@focusrite.com

Phone (UK): +44 (0)1494 462246

Phone (USA): +1 (310) 322-5500

Troubleshooting

If you are experiencing problems with your RedNet 5/HD32R, we recommend that in the first instance, you visit our Support Help Centre at: focusritepro.zendesk.com