



▶▶ NEUMANN.BERLIN

▶ KH 150

TWO-WAY ACTIVE LOUDSPEAKER

INSTRUCTION MANUAL





Contents

| | |
|--|----|
| The KH 150 studio monitor | 3 |
| Delivery includes | 3 |
| About this manual | 3 |
| Product overview | 4 |
| Setting up and connecting the loudspeaker | 5 |
| Preparing the loudspeakers | 5 |
| Preparing the room | 5 |
| Positioning the loudspeakers | 6 |
| Connecting audio signals | 7 |
| Connecting network cables | 9 |
| Connecting/disconnecting the loudspeaker to/from the power supply system .. | 9 |
| Configuring and using the loudspeaker | 10 |
| Switching the loudspeaker on/off | 10 |
| Functionality of the Neumann logo | 11 |
| Switches on the SETTINGS panel | 12 |
| Resetting the loudspeaker settings | 13 |
| Firmware update | 13 |
| Adapting loudspeakers to the environment using the switches on the backplate | 14 |
| Adjusting the acoustical level | 15 |
| Configuring standby mode | 16 |
| Customizing standby behavior | 17 |
| Cleaning and maintaining the loudspeaker | 19 |
| Troubleshooting | 19 |
| Specifications | 20 |
| Acoustical measurements and block diagram | 20 |
| Accessories | 20 |
| Installation angles | 21 |



The KH 150 studio monitor

Thank you for purchasing a Neumann studio monitor. The loudspeaker features a Mathematically Modeled Dispersion™ Waveguide (MMD™), DSP acoustical controls, a digital S/PDIF input and output, network control capabilities, and an extensive range of mounting hardware. This allows the loudspeaker to be used in diverse acoustical conditions, with any source equipment and in a wide variety of physical locations. The KH 150 represents the latest in acoustic and electronic simulation and measurement technologies to ensure the most accurate sound reproduction possible.

Depending on the size, Neumann's two-way loudspeaker systems are designed for use as near field monitors or as rearward or ceiling-mounted loudspeakers in larger multi-channel systems. They can be used in project, music, broadcast, and post production studios for tracking, mixing, and mastering.

Delivery includes

- 1 KH 150
- 4 Self-adhesive feet
- 1 Quick guide
- 1 Safety instructions
- 1 Power cord (EU, UK, USA, China or Korea)

About this manual

This operating manual describes the physical setup and autonomous operation of the loudspeaker. For information on how to control the speaker over a network using the **MA 1 – Automatic Monitor Alignment** software, please refer to the software help.

The **MA 1 – Automatic Monitor Alignment** software is available for macOS and Windows and offers the following advantages:

- Precise adaptation to your listening preferences
- Calibration to the listening environment
- Optimized stereo imaging
- Perfect matching of amplitude and phase to subwoofers
- Compensation for suboptimal listening situations
- Settings for system level, display brightness, delay and other features

The **MA 1 – Automatic Monitor Alignment** software is available at www.neumann.com.



Product overview

Front panel

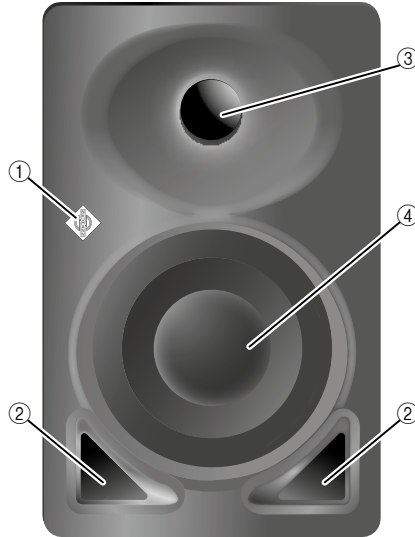

- ① Neumann logo
 - For information on the functionality of the Neumann logo, refer to the chapter “Functionality of the Neumann logo”
- ② Bass reflex ports
- ③ Tweeter with tweeter guard
- ④ Woofer with woofer guard

Back panel

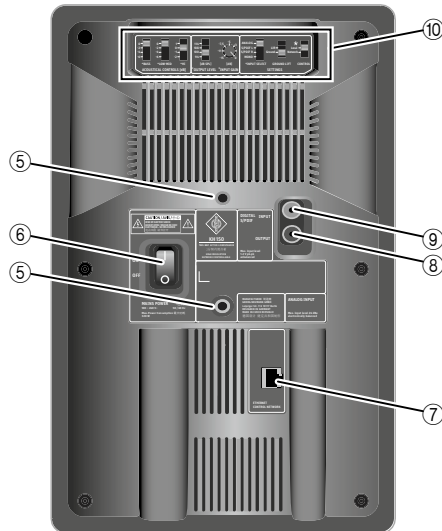

- ⑤ Threaded inserts (M6) for Neumann mounting hardware
- ⑥ On/off switch
- ⑦ RJ-45 socket for network control
- ⑧ DIGITAL S/PDIF OUTPUT (RCA)
- ⑨ DIGITAL S/PDIF INPUT (RCA)
- ⑩ Control switches

Bottom

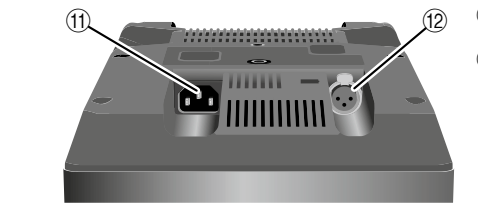

- ⑪ IEC power socket
- ⑫ Analog input (XLR-3F)



Setting up and connecting the loudspeaker



CAUTION

Danger of injury and material damage due to tipping/dropping of the product!

If improperly mounted, the product and/or the mounting hardware (e.g. rack) can tip over or fall.

- ▶ Always have the product mounted by a qualified specialist according to local, national and international regulations and standards.
- ▶ Use the mounting systems recommended by Neumann and always provide sufficient additional protection against tipping or falling.

CAUTION

Damage to the product due to overheating!

If air cannot circulate properly around the cooling vents on the rear of the product, the amplifier(s) may overheat, leading to premature activation of the thermal protection system which limits the maximum output level of the loudspeaker. In rare cases, damage to the product may also occur.

- ▶ Never cover the cooling vents.
- ▶ When installing the product into tight spaces such as wall recesses, maintain an air gap of at least 5 cm around the top, rear and side panels of the product and provide sufficient air circulation. If necessary, use forced-air cooling.



For further information on setting up loudspeakers, please refer to the “Questions & Answers” section on the product page at www.neumann.com.

For more information on building systems using Neumann loudspeaker products, please refer to the Product Selection Guide at www.neumann.com

Preparing the loudspeakers

CAUTION

Risk of staining surfaces!

Some surfaces treated with varnish, polish or synthetics may suffer from stains when they come into contact with other synthetics. Despite a thorough testing of the synthetics we use, we cannot rule out the possibility of staining.

- ▶ Do not place the loudspeaker on delicate surfaces.

To place the loudspeaker on a flat surface:

- ▶ Attach the supplied self-adhesive feet to the bottom of the cabinet.

This reduces the risk of scratching the surface and acoustically isolates the loudspeaker from the surface.

Preparing the room

- ▶ Arrange all acoustically relevant surfaces and objects symmetrically on either side of the listening axis of the room (left/right).
- ▶ Minimize the sound that is reflected back to the listening position by using angled surfaces and/or acoustical treatment.



This product has been optimized for use in recording studios. In order to not affect the quality of playback, make sure that the product is used in an EMC (electromagnetically compatible) environment, ideally without electromagnetic radiation from other devices.



Positioning the loudspeakers

- Carry out the following steps very accurately, since the more accurate the physical arrangement of the loudspeakers in the room, the more accurate the reproduction will be at the listening position.

Distances

- Observe the recommended distances between the loudspeakers and your listening position:
 - Recommended listening distance: 1.0 m – 2.5 m
 - Min./max. listening distance: 0.75 m – 6.0 m

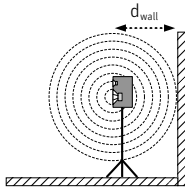

Angular positioning of the loudspeakers

- Avoid positioning the loudspeaker at a distance (d_{wall}) of 0.8 to 1.75 m from the wall behind the loudspeaker. When positioning bass managed loudspeakers, avoid a distance (d_{wall}) of 0.8 to 1 m from a solid wall behind the loudspeaker. Similarly, avoid these distances from solid side walls or a solid ceiling. Respecting these positioning limitations reduces the chances of dips in the low frequency response (comb filtering) caused by strong reflections.

- Print out the “Installation angles” diagram that can be found at the end of this operating manual.

- Place the diagram at the listening position or the center of the listening area.

- Using a tape measure, place the loudspeakers at the same distance from the center of the diagram “Installation angles”. To ensure good imaging, do this at an accuracy of at least 1 cm.

- If the loudspeakers cannot be placed at the same distance from the listening position, compensate for distance differences > 1 cm by delaying closer loudspeakers by 30 μ s/cm. The **MA 1 – Automatic Monitor Alignment** software automatically compensates for different distances between the loudspeakers and the listening position.

- Arrange the loudspeakers as follows:

- 2.0 systems (stereo): $\pm 30^\circ$, plus optional subwoofer(s)
- 5.1 systems:
 - ITU-R BS.775-1: $0^\circ, \pm 30^\circ, \pm 110^\circ (\pm 10^\circ)$, plus optional subwoofer(s) (center, front left/right, surround left/right)
 - ANSI/SMPTE 202M: $0^\circ, \pm 22.5^\circ$, one surround array left and right, plus optional subwoofer(s)
- 7.1 systems: $0^\circ, \pm 30^\circ, \pm 90^\circ, \pm 150^\circ$, plus optional subwoofer(s) (center, front left/right, side left/right, back left/right)
- 3D systems See the recommendations from Dolby, DTS, Auro3D and ITU-R BS.2051-0 for loudspeaker positioning.

The acoustical axis of the loudspeaker is between the bass and tweeter drivers.

- Always point the acoustical axis, in the horizontal and vertical planes, towards the listening position.

i The acoustical axis is a line perpendicular to the loudspeaker’s front panel along which the microphone was placed to tune the loudspeaker’s crossover when the monitor was designed. Pointing the acoustical axis, in the horizontal and vertical planes, toward the listening position or center of the monitoring area will give the best measured and perceived transient response quality.

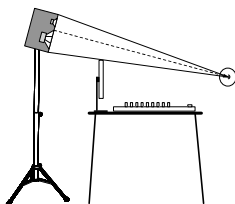
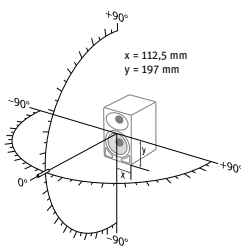

- Position the loudspeaker so that there is a direct line of sight from the listening position to the bass and tweeter drivers.

- Make sure that the ports are not blocked or partially covered.

- Keep sharp edges away from the port outlets, as they can cause air noise.



Connecting audio signals

▶ Always use good quality cables to achieve the maximum cable lengths shown below:

| Signal (connector) | Cable length | Connection method |
|--------------------|--------------|--|
| Analog (XLR) | Up to 100 m | Directly to the ANALOG INPUT socket (XLR) (see below) |
| Analog (jack) | Up to 100 m | Via an adapter (jack–XLR) to the ANALOG INPUT socket (XLR) (see below) |
| Analog (RCA) | Up to 10 m | Via an adapter (RCA–XLR) to the ANALOG INPUT socket (XLR) (see below) |
| Digital (RCA) | Up to 200 m | Directly to the DIGITAL INPUT socket (RCA) (see below) |
| Digital (BNC) | Up to 200 m | Via an adapter (BNC–RCA) to the DIGITAL INPUT socket (RCA) (see below) |
| Digital (XLR) | Up to 50 m | Via an adapter (XLR–RCA) to the DIGITAL INPUT socket (RCA) (see below) |

▶ If possible, use a balanced, analog signal connection (XLR, stereo jack) to prevent interference in the cable.

Connecting analog signals to the loudspeaker

Connecting XLR or RCA cables

▶ Connect the left and right output of your analog audio source to the XLR input sockets of the respective loudspeaker.

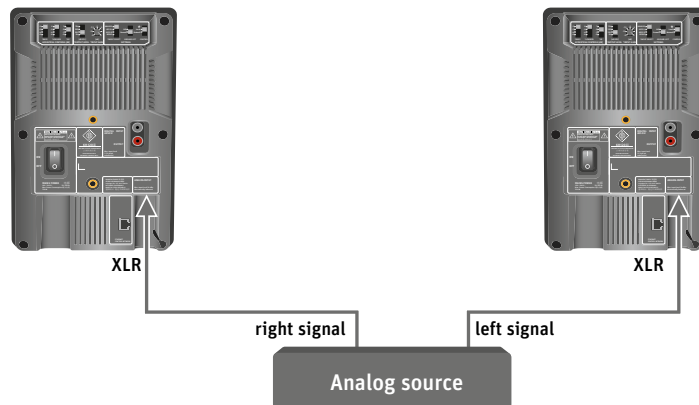

- ▶ Use an XLR adapter (not supplied) to connect unbalanced cables (e.g. RCA cables).
- ▶ Use this adapter directly at the source and connect the adapter via a properly wired balanced XLR cable to the loudspeaker. The connection of pin 3 to ground should be as close as possible to the source to maximize hum rejection on the cable.
- ▶ Use the following wiring if you want to make your own RCA-to-XLR cable:

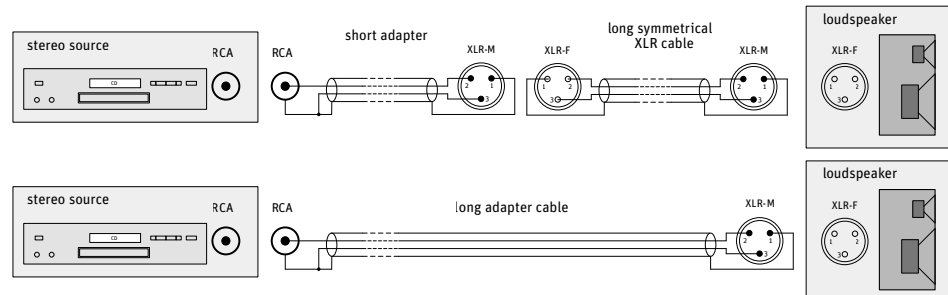



Connecting digital signals to the loudspeaker

Connecting AES3 cables

- ▶ Connect the digital AES3id or S/PDIF output signal of your audio source to the DIGITAL S/PDIF INPUT socket on the first loudspeaker (see figure below).

i The loudspeaker only supports non-encoded AES3 and S/PDIF signals. Encoded signals such as MP3, DTS or Dolby Digital are not supported. The cable connection must be unbalanced with a characteristic impedance of 75 Ω.

i Only one cable is needed for uncompressed AES3 and S/PDIF digital signals (single-wire mode). They contain two audio channels: “subframe A” and “subframe B.” Usually, the audio channels are:

| Subframe A | Subframe B |
|---------------|----------------|
| Left | Right |
| Center | LFE |
| Surround left | Surround right |
| Back left | Back right |

A clock input is not required because loudspeakers are not audio sources and the converters are clocked to a very stable internally generated clock source.

i If the signal source is based on internal digital signal processing, it is recommended that you choose a digital connection between the signal source and the loudspeaker. This eliminates the need for additional signal conversion from digital to analog in the source and from analog to digital in the loudspeaker. This also applies if you are connecting to an upstream DSP subwoofer (e.g. KH 750 DSP). This should be connected to the loudspeakers via its digital output.

Note that the supplied digital signal often has a maximum signal level, and that the level in the source is often not adjustable. Therefore, before making the digital connection, set the OUTPUT LEVEL switch on the loudspeaker to 94 dB SPL and the INPUT GAIN knob to -15 dB.

- ▶ Connect the DIGITAL S/PDIF OUTPUT socket on the first loudspeaker to the DIGITAL S/PDIF INPUT socket on the second loudspeaker.
- ▶ Set the INPUT SELECT switch on the left loudspeaker to S/PDIF L and the INPUT SELECT switch on the right loudspeaker to S/PDIF R. The CONTROL switch must be in the Local position.

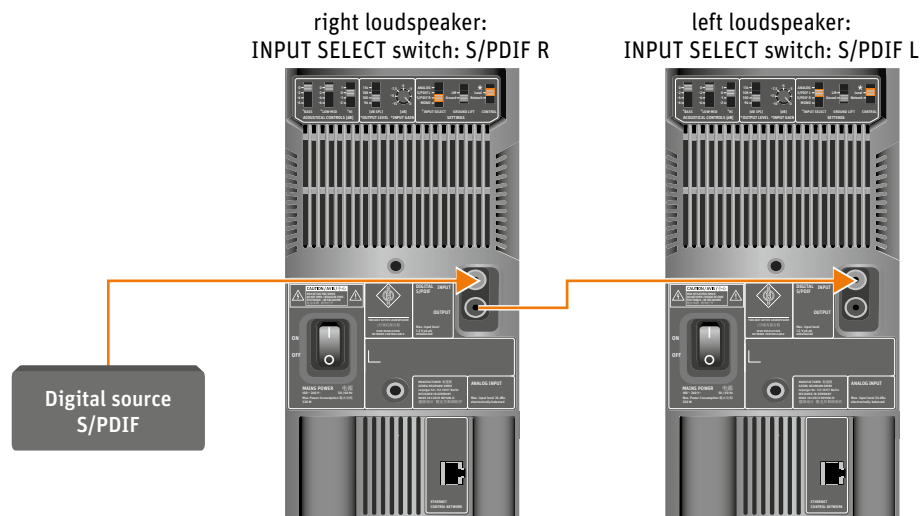

i The settings of the first loudspeaker in the signal chain are not looped through to the second loudspeaker. Each loudspeaker must be configured separately.

When using a daisy chain connection as shown here, the signal from the second loudspeaker is not delayed relative to the first loudspeaker.

The output of the final loudspeaker does not have need to be terminated with an additional 75 ohms. It is terminated internally.

Connecting network cables

To use the extended functionality offered by the **MA 1 – Automatic Monitor Alignment** software, the loudspeaker must be connected via the ETHERNET socket to a standard network switch using a user supplied standard Ethernet cable (Cat 5 or better). The maximum length of the cable is 100 m.

Refer to the **MA 1 – Automatic Monitor Alignment** software for information about how to use loudspeakers in a network.

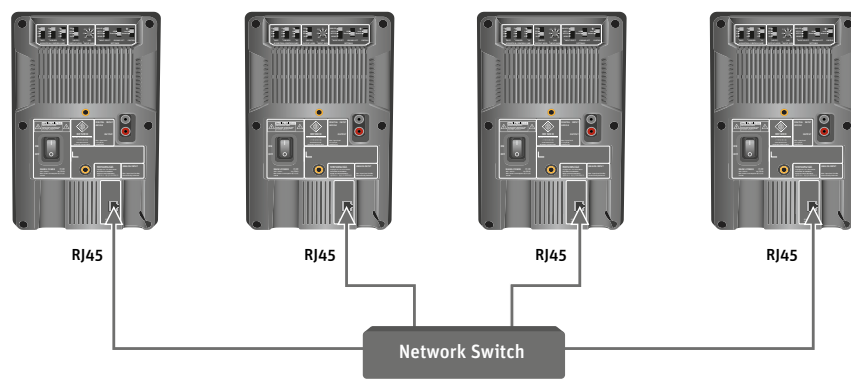

i This device supports Sennheiser Sound Control (SSC) based on TCP and IPv6. The static IPv6 address of the device can be determined with mDNS. For more information about SSC, see the Sennheiser website.

Connecting/disconnecting the loudspeaker to/from the power supply system

To connect the loudspeaker to the power supply system:

- ▶ Make sure that the on/off switch is set to “0”.
- ▶ Connect the IEC connector on the supplied power cable to the power supply socket.

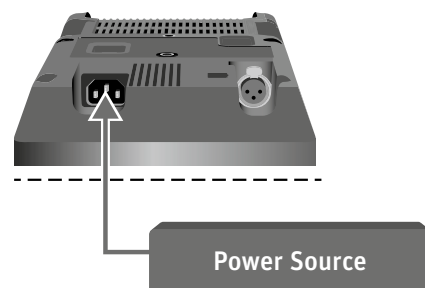

- ▶ Connect the wall plug on the power cable to a suitable wall outlet.

To completely disconnect the loudspeaker from the power supply system:

- ▶ Set the on/off switch to “0”.
- ▶ Pull the wall plug out of the wall outlet.



Configuring and using the loudspeaker

Switching the loudspeaker on/off

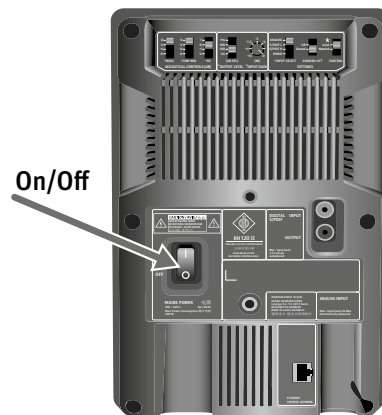

▶ Set the on/off switch to:

- “I” to switch on the loudspeaker. The Neumann logo lights up solid red while the DSP system boots up. After approximately 5 seconds it turns white indicating the loudspeaker is ready to be used. If the logo brightness has been set to less than 100% in the **MA 1 – Automatic Monitor Alignment** software, it will be dimmed or off after the boot phase is complete.
- “OFF” to switch off the loudspeaker. The Neumann logo switches to red for a short moment and then goes off.



There is a five second delay before sound can be heard from the loudspeaker in order to avoid noises (pops) from preceding equipment switched on at the same time. Conversely, switching off the loudspeaker immediately mutes the audio.



Functionality of the Neumann logo

| Action | Logo indication |
|---|--|
| Firmware activities | |
| Loudspeaker is booting up, muted | Solid red for 5 seconds |
| Loudspeaker is shutting down, muted | Brief red light |
| Loudspeaker boot up error | Red flashing (fast) |
| Loudspeaker firmware is being updated | Solid pink |
| Loudspeaker resetting to factory default settings | Pink flashing (very fast) |
| Normal operation | |
| Loudspeaker switched on and ready for operation (can be dimmed using MA 1 – Automatic Monitor Alignment software) | Solid white |
| MA 1 – Automatic Monitor Alignment software is saving the changes to the loudspeaker | Solid white |
| Protection and standby | |
| Peak limiter active | Brief red light in time with the pulse peaks |
| Thermolimiter active | Solid red as long as level reduction is active |
| Overload protection | Solid red as long as the loudspeaker is muted to prevent overheating |
| Other protection system is activated (takes priority over other indications) | Red |
| Calibration with the MA 1 – Automatic Monitor Alignment software | |
| Identifying the loudspeaker | Flashing pink (2 Hz) |
| Loudspeaker is selected | Solid white |



Switches on the SETTINGS panel

The three switches on the SETTINGS panel control different functions.

CONTROL

The CONTROL switch toggles between backplate mode and network mode.

Local – backplate mode

If the CONTROL switch is in the **Local** position, the loudspeaker will not respond to network commands. The loudspeaker can only be controlled using the controls on the backplate.



Network – network mode

If the CONTROL switch is in the **Network** position, the loudspeaker responds to the network commands from the **MA 1 – Automatic Monitor Alignment** software. The controls marked * on the back of the loudspeaker are ignored.

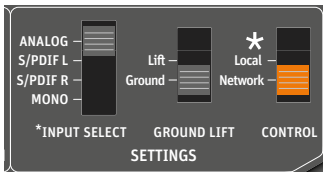

If the CONTROL switch is set to **Network** but there is no network connection and the **MA 1 – Automatic Monitor Alignment** software is not active, the most recent network configuration is used.

If you have configured any settings via the **MA 1 – Automatic Monitor Alignment** software and you remove the network cable, the current settings will stay active.

By switching from network control to local control, you can easily switch between a configuration set in the **MA 1 – Automatic Monitor Alignment** software and settings made directly on the loudspeaker.

This is useful if you want to temporarily use the loudspeaker in a location other than the studio environment you configured.

The loudspeaker does not lose its settings even when you disconnect it from the network or the power supply.

INPUT SELECT

The INPUT SELECT switch toggles between analog and digital input.

Set the INPUT SELECT switch to **ANALOG** if you intend to feed an analog signal into the XLR socket labeled **ANALOG INPUT**.

Set the INPUT SELECT switch to **S/PDIF L**, **S/PDIF R** or **MONO** if you intend to feed a digital AES3id or S/PDIF signal into the RCA socket labeled **DIGITAL S/PDIF INPUT**.

Set the INPUT SELECT switch on the left loudspeaker to **S/PDIF L** and the right speaker's INPUT SELECT switch to **S/PDIF R** for normal stereo mode.

If the loudspeakers are used as surround speakers in larger systems, the channels must be configured based on how they are assigned in the source. In this case, channel A (digital subframe A) corresponds to the left channel and channel B (digital subframe B) corresponds to the right channel.

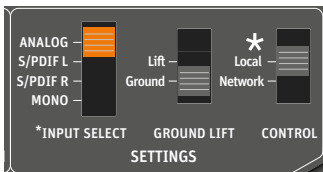

| Switch position | Meaning |
|-----------------|--|
| ANALOG | XLR socket ANALOG INPUT is active |
| S/PDIF L | Digital subframe A, RCA socket DIGITAL S/PDIF INPUT is active |
| S/PDIF R | Digital subframe B, RCA socket DIGITAL S/PDIF INPUT is active |
| MONO | Digital subframe A is added to digital subframe B with 4.5 dB damping, RCA socket DIGITAL S/PDIF INPUT is active |



GROUND LIFT

The GROUND LIFT switch internally separates pin 1 of the XLR input socket from the electronics chassis ground.

If there is humming or buzzing noise coming from the loudspeaker, first search for the cause of the noise:

- ▶ Disconnect all input cables from the loudspeaker.

If the noise goes away, it is probably coming from the audio source or source cabling. It might be possible to eliminate the noise by disconnecting the ground from the input signals (activating ground lift).

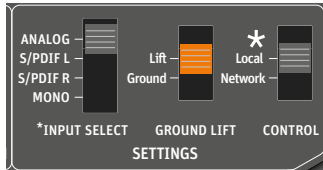

To activate the ground lift:

- ▶ Reconnect the signal cables and set the GROUND LIFT switch to **Lift**.

 For safety reasons, the electronics chassis ground is always connected to the ground contact of the power supply. Never disconnect the ground contact of the power cable from ground.

Resetting the loudspeaker settings

You can use the **MA 1 – Automatic Monitor Alignment** software to configure the loudspeaker beyond what is available on the backplate.

To reset these internal loudspeaker parameters to the factory settings:

- ▶ Switch on the loudspeaker.
- ▶ While the logo is flashing during the boot up phase, move the CONTROL switch up and down repeatedly. Continue until the logo turns solid white for a few seconds. The logo begins quickly flashing red for a few seconds before turning white again.

Firmware update

Firmware updates are done via the **MA 1 – Automatic Monitor Alignment** software. When you open the software, it scans the network for loudspeakers and checks if the firmware is up to date. If a firmware update is required, you will be notified. Follow the instructions shown on screen. It takes approximately 10 seconds per loudspeaker to do the update.

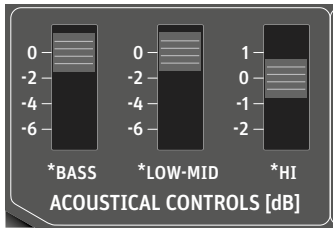

Adapting loudspeakers to the environment using the switches on the backplate

When the switches BASS, LOW-MID and HI on the ACOUSTICAL CONTROLS panel are set to 0, the loudspeaker is designed to have a flat frequency response in anechoic conditions.

The frequency response will change in your monitoring environment. The loudspeaker's frequency response will also change based on its position in the room. The same loudspeaker installed in different positions in the same room may require different acoustical control settings. In a symmetrical installation, left/right pairs (front or back) will probably have the same acoustical settings.

- ▶ Before using your loudspeaker system for the first time, align the frequency response of the loudspeakers in the room in order to obtain the desired transfer behavior.
- ▶ Repeat the above step if you change the physical conditions in your studio.
- ▶ At your listening position, determine the frequency response of each loudspeaker.

 These switches are not intended for adjusting the sound to your preferences during playback. They are used to adapt the loudspeaker to the acoustical conditions of the room and the position in the room to provide as neutral a response as possible.

| Switch | Function | Possible settings |
|---------|--|-------------------|
| BASS | Compensates for acoustical loading in the low frequency range due to nearby large solid boundaries (e.g. walls). | 0, -2, -4, -6 dB |
| LOW-MID | Compensates for acoustical loading in the low-mid frequency range due to large, reflecting objects (e.g. mixing consoles, tables or screens) in the vicinity of the loudspeaker. | 0, -2, -4, -6 dB |
| HI | Compensates for insufficient or excessive high-frequency damping in the room. | +1, 0, -1, -2 dB |

The following settings can be used as a starting point for further adjustment:

| Loudspeaker position | Switch | | |
|---|--------|---------|-------|
| | BASS | LOW-MID | HI |
| In a corner | -6 dB | -2 dB | — |
| Next to an acoustically solid wall (e.g. brick, concrete) | -4 dB | — | — |
| Next to an acoustically soft wall (e.g. drywall) | -2 dB | — | — |
| Free standing in an untreated room | -2 dB | — | -1 dB |
| Free standing in a well-treated room | — | — | — |
| In a small room with strong side wall reflections | -4 dB | 0 dB | — |
| Near a small desktop or small reflecting surface* | — | -2 dB | — |
| Near a large desktop or large reflecting surface* | — | -4 dB | — |

*Use these settings in addition to one of the top settings.

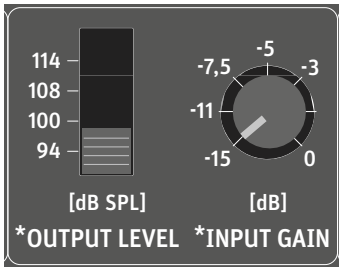

Adjusting the acoustical level

- ▶ On your loudspeakers, set the OUTPUT LEVEL switch to 94 dB SPL and the INPUT GAIN knob to -15 dB.
- ▶ Play a broadband pink noise test signal that is set to -18 dBFS (Europe) or -20 dBFS (USA) on the mixing console's output level meters.
- ▶ Measure the sound pressure level at the listening position. Use a sound level meter with the following settings:
 - "C" weighted
 - Slow integration time
- ▶ Set the OUTPUT LEVEL switch and INPUT GAIN control of your loudspeakers so that the desired acoustic level is obtained.

Recommended sound pressure levels:

| Application | Sound pressure level |
|-------------|-----------------------------|
| Film | 85 dB(C) |
| Broadcast | 79 to 83 dB(C) |
| Music | No defined reference levels |

If the Neumann logo flashes red, the loudspeaker's protection system has been activated. To avoid this and achieve the desired output level, use larger loudspeakers or add a bass managed subwoofer to the system.

Examples of sound pressure levels as a function of the loudspeaker's input and output level:

| Input signal dBu | 0 (0.775 V) | 0 (0.775 V) | +4 (1.23 V) | -20 (77.5 mV) |
|---------------------------------------|----------------|----------------|----------------|------------------|
| INPUT GAIN knob dB | 0 | -15 | -4 | -15 |
| OUTPUT LEVEL switch dB SPL | 100 | 100 | 94 | 114 |
| Sound pressure level dB SPL in 1 m | 100 | 85 | 94 | 79 |

i If your signal source is not used as a reference for the listening level, make sure that the level of the source is higher and the level on the loudspeakers is lower. This reduces the self-noise from the source and any extraneous signals in the input line.



Configuring standby mode

The loudspeaker has an automatic standby function that is dependent on the input signal. It switches the loudspeaker into power saving mode when it hasn't been used for a period of time.

Standby means that the network interface, signal processing circuitry and power amplifiers are all powered down. Standby mode is automatically deactivated when a sufficiently large audio signal is detected at the input. The time taken to resume normal operation and hear sound is 5 seconds.

When the INPUT SELECT switch is in the ANALOG position, the loudspeaker switches to standby mode after 90 minutes without an input signal or with only a very low input level.

For the standby function to be activated, the incoming signal must not cause the loudspeaker's output level to exceed an internally specified threshold for the specified standby time. This therefore depends on both the amplitude of the input signal and the level setting on the loudspeaker itself. The level threshold is 20 dB SPL at a distance of 1 m in free field conditions.

Even if there is no input signal, however, interference and crosstalk in the signal source or input line can cause the loudspeaker to wake up or prevent the loudspeaker from switching to standby mode in the first place.

If the INPUT SELECT switch is in the positions S/PDIF L, S/PDIF R or MONO, the loudspeaker switches to standby mode after 90 minutes when there is no digital clock signal or the digital input signal is muted. In these modes, the loudspeaker wakes up when the digital signal reappears.

Standby mode will remain active as long as the sampling rate of the applied S/PDIF signal does not change.

When switching to standby mode, a slight pop may be heard.

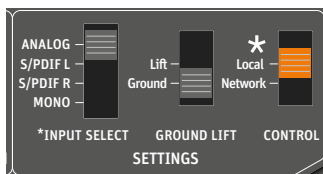

Standby in backplate mode

- Set the CONTROL switch to Local.

The idle time for standby mode is 90 minutes.

The output level depends on the positions of the OUTPUT LEVEL switch and the INPUT GAIN knob on the back of the loudspeaker. Set them as required for your setup.

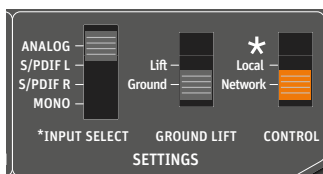

Standby in network mode

- Set the CONTROL switch to Network.

You can disable automatic standby mode using the MA 1 – Automatic Monitor Alignment software.



Customizing standby behavior

Standby is too sensitive

If standby is too sensitive, the loudspeaker will not enter standby mode when it is supposed to, or it will wake up from standby mode when it is not supposed to.

Possible reasons:

The source may contain extraneous noise or noise peaks that wake the loudspeaker up or prevent it from going into standby. This can also cause loudspeakers with the same settings to behave differently.

You can determine if extraneous noise or noise peaks are responsible for the behavior as follows:

- ▶ Set the CONTROL switch to **Local**.
- ▶ Set the OUTPUT LEVEL switch to 114 dB to listen for possible extraneous noise.
- ▶ Listen carefully to identify noise peaks.
- ▶ Alternatively, you can record the loudspeaker output signal with a microphone and analyze the recording.
- ▶ Try to find out whether switching other devices in the house on or off has an effect (e.g. refrigerator or similar).

You can check that the standby feature is working correctly by connecting a short XLR cable to the loudspeaker input without connecting a device to the other end of the cable.

Backplate mode:

- ▶ In backplate mode, set the OUTPUT LEVEL switch to 100 dB.
The loudspeaker should enter standby mode after 90 minutes.

Network mode:

- ▶ In network mode, use the **MA 1 – Automatic Monitor Alignment** software to set the standby threshold to 30 dB and the standby time to any value.
The speaker should enter standby mode after the time you set.



Since the loudspeaker continuously monitors the input signal, peaks that come from the source or are induced in the cable can also prevent the loudspeaker from switching to standby mode. Make sure that there are no peaks coming from the source or induced in the cable that can wake up the loudspeaker.



Standby is not sensitive enough

If standby is not sensitive enough, the loudspeaker goes into standby mode when it is not supposed to, or does not wake up from standby mode when it is supposed to.

Possible reasons:

The standby threshold is above the signal level. If the input and output levels of the loudspeaker are set very low, but the source has a high level, this can result in a very quiet output signal.

Backplate mode:

- ▶ In backplate mode, raise the source output level or the input and output levels of the loudspeaker in order to raise the sound pressure level above the standby threshold.

Network mode:

- ▶ In network mode, raise the source output level or the input and output levels of the loudspeaker in order to raise the sound pressure level above the standby threshold.

In general, you should set the loudspeaker level as low as possible (e.g., the INPUT GAIN knob to 0, the OUTPUT LEVEL switch to 94 or 100 dB SPL) and the level of your source as high as possible to obtain the best possible signal-to-noise ratio and minimize induced extraneous noise.

Ideally, the source should be connected to the loudspeaker using a balanced XLR cable (XLR to XLR or jack to XLR). If only an unbalanced source is available, you should connect it as shown in the following figures.

Headphone output (TV or hi-fi system): miniature jack (3.5 mm) or jack (6.3 mm):

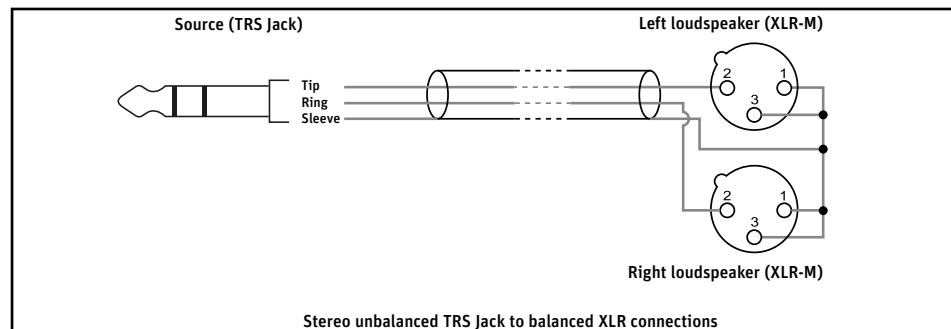

RCA line output from a television (if the output level is adjustable) or RCA output (pre-amp) from an AV receiver. One cable is required per speaker:

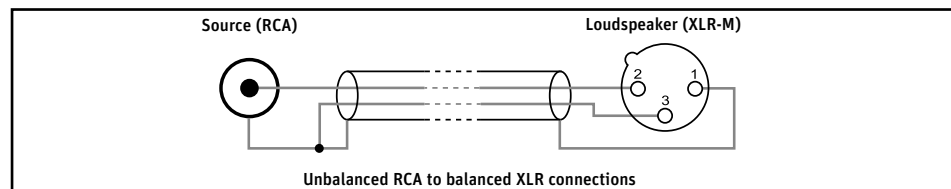



Cleaning and maintaining the loudspeaker

CAUTION

Damage to the product caused by liquids!

Liquids entering the product can cause a short-circuit in the electronics and damage or even destroy the product.

▶ Keep all liquids away from the product!

- ▶ Before cleaning, disconnect the product from the power supply.
- ▶ Use a soft, dry, and lint-free cloth to clean the product.
- ▶ Be careful not to accidentally adjust the controls when cleaning.

Troubleshooting

| Problem | Cause | Solution |
|--|--|---|
| The Neumann logo is off, no sound is heard from the loudspeaker. | The loudspeaker's main internal fuse has blown. | Have the product checked by an authorized Neumann service partner. There is no plug fuse in the device. |
| The Neumann logo is off or not clearly visible, but sound is heard from the loudspeaker. | The Neumann logo is switched off or dimmed. | Switch on the Neumann logo and switch off the dimming (see page 10). |
| The loudspeaker is buzzing. | Incorrect wiring in the audio cable and/or poor quality grounding in the audio cable. | Check the cabling, especially if unbalanced cabling has been used – see the cable wiring diagram on page 7. Use gold-plated connectors. Set the output level of the loudspeaker as low as possible and set the output level of the audio source as high as possible, without causing it to clip. Set the GROUND LIFT switch to the Lift position. |
| The loudspeaker sounds very "thin" in the bass. The low frequency response is very low. | Incorrect wiring in the audio cable or adapter. | Check the cabling, especially if unbalanced cabling has been used – see the cable wiring diagram on page 7. |
| | One loudspeaker is out of phase with the other. This results in cancellation in the low frequency range. | Check the cabling, especially if unbalanced cabling has been used – see the cable wiring diagram on page 7. Check the settings in the signal source. |
| Standby is too sensitive or not sensitive enough. | Incorrect standby settings, or noise peaks / extraneous noise in the source. | Check the standby settings and signal source – see "Customizing standby behavior" on page 17. |

For further information, please refer to the "Questions & Answers" section on the product page at www.neumann.com.



Specifications

For a complete list of specifications, see the loudspeaker's product page at www.neumann.com.

| Product properties | |
|---|--|
| Power supply | 100 to 240 V~, 50/60 Hz |
| Power consumption (standby/idle) | 0.3 W / 15 W |
| Power consumption (full load) | 320 W |
| Dimensions (H x W x D) | 345 x 225 x 273 mm 13.6" x 8.8" x 10.7" |
| Weight | 8.0 kg |
| Drivers (woofer, tweeter) | 165 mm (6.5"), 25 mm (1") |
| Temperature | |
| Operation and storage, unpacked | +10 °C to +40 °C |
| Transport and storage, packed in original packaging | -25 °C to +60 °C |
| Relative humidity | |
| Operation and storage, unpacked | max. 75% (non-condensing) |
| Transport and storage, packed in original packaging | max. 90% (non-condensing) |

Acoustical measurements and block diagram

Additional technical data such as acoustical measurements and a block diagram can be found on the loudspeaker's product page at www.neumann.com.

Accessories

| Product | Description |
|---------|------------------------------------|
| LH 28 | Tripod stand adapter |
| LH 29 | TV spigot (lighting stand adapter) |
| LH 32 | Wall bracket |
| LH 37 | Subwoofer adapter |
| LH 43 | Surface mounting plate |
| LH 45 | Wall bracket |
| LH 46 | Adjustable ceiling drop adapter |
| LH 47 | Mounting adapter plate |
| LH 48 | Tripod adapter plate |
| LH 61 | Adjustable L-bracket |
| LH 64 | Omnimount/VESA adapter |
| LH 66 | Table stand for KH 150 |

 For a full list of mounting accessories, see the **Mounting Matrix** at www.neumann.com.



Installation angles

