

LIVE SOUND SOLUTIONS

*S*tdiomaster



*S*tdiomaster

UNIT II,
TORC MK
CHIPPENHAM DRIVE
KINGSTON
MILTON KEYNES
MK10 0BZ

UNITED KINGDOM.
TEL: +44(0)1908 281072 EMAIL ENQUIRIES@STUDIOMASTER.COM

www.studiomaster.com

USER GUIDE

**SESSIONMIX 822/
1222/1622**

PROFESSIONAL MIXER

IMPORTANT SAFETY SYMBOLS



Use only with the cart, stand, tripod, bracket, or table specified by the manufacturer, or sold with the apparatus. When a cart is used, use caution when moving the cart/apparatus combination to avoid injury from tip-over.



The symbol is used to indicate that some hazardous live terminals are involved within this apparatus, even under the normal operating conditions, which may be sufficient to constitute the risk of electric shock or death.



The symbol is used in the service documentation to indicate that specific component shall be replaced only by the component specified in that documentation for safety reasons.



Protective grounding terminal



Alternating current/voltage

ON: Denotes the apparatus is turned on



Hazardous live terminal

OFF: Denotes the apparatus is turned off.

WARNING: Describes precautions that should be observed to prevent the danger of injury or death to the operator.

CAUTION: Describes precautions that should be observed to prevent danger of the apparatus.

1. IMPORTANT SAFETY INSTRUCTIONS

- **Read these instructions.**
- **Keep these instructions.**
- **Heed all warning.**
- **Follow all instructions.**

• **Water & Moisture**

The apparatus should be protected from moisture and rain, can not used near water, for example: near bathtub, kitchen sink or a swimming pool, etc.

• **Heat**

The apparatus should be located away from the heat source such as radiators, stoves or other appliances that produce heat.

• **Ventilation**

Do not block areas of ventilation opening. Failure to do could result in fire. Always install accordance with the manufacturer's instructions.

• **Object and Liquid Entry**

Objects do not fall into and liquids are not spilled into the inside of the apparatus for safety.

• **Power Cord and Plug**

Protect the power cord from being walked on or pinched particularly at plugs, convenience receptacles, and the point where they exit from the apparatus.

Do not defeat the safety purpose of the polarized or grounding-type plug. A polarized plug has two blades with one wider than the other. A grounding type plug has two blades and a third grounding prong. The wide blade or the third prong is provided for your safety. If the provided plug does not fit into your outlet, refer

to electrician for replacement.

• **Power Supply**

The apparatus should be connected to the power supply only of the type as marked on the apparatus or described in the manual. Failure to do could result in damage to the product and possibly the user.

Unplug this apparatus during lightning storms or when unused for long periods of time.

Where the MAINS plug or an appliance coupler is used as the disconnect device, the disconnect device shall remain readily operable.

• **Fuse**

To prevent the risk of fire and damaging the unit, please use only of the recommended fuse type as described in the manual. Before replacing the fuse, make sure the unit turned off and disconnected from the AC outlet.

• **Electrical Connection**

Improper electrical wiring may invalidate the product warranty.

• **Cleaning**

Clean only with a dry cloth. Do not use any solvents such as benzol or alcohol.

• **Servicing**

Do not implement any servicing other than those means described in the manual. Refer all servicing to qualified service personnel only.

• Only use accessories/attachments or parts recommended by the manufacturer.

1. Introduction:

Thank you for purchasing SESSIONMIX compact mixer which features external universal voltage adapter 100-240V/DC12V, compression function of each mic channel to keep crystal clear sound during performance. The mixer can play the music via SD card/USB/bluetooth. The mic sound or music of line in can be recorded to SD card/USB to suit for the requirement of solo or band performance or conference recording. SESSIONMIX can also be connected with PC for playback and recording.

Application:

suitable for the applications in PA system or indoor recording, e.g. Movie/TV/music recording in theatre/dancing hall/bar/conference hall, etc;

2. Function

- 1) 6-14 CH MIC/line and 2CH stereo inputs.
- 2) Compression function of mic channels (0-9dB).
- 3) Built-in USB/SD card/bluetooth playing/recording function.
- 4) 48V phantom power for condenser mic.
- 5) Built-in 16 program DSP with adjustable delay for wonderful effect.
- 6) Main outputs with 2X8 accurate meter to monitor output level.
- 7) Universal voltage 100V-240V.
- 8) MP3 interface can connect with PC for playback and recording.
- 9) L/R main output, two groups, and two AUX outputs..
- 10) With foot switch interface.

Specification

Mono input			
Mic input	Bal input		
Frequency response	10 Hz to 30 kHz, +/-3 dB		
THD(THD&N)	0.03% at +4 dBu, 22Hz-20kHz A-weighted		
Compression	GAIN:0-9dB, THRESHOLD: 20dB [↓] 5dB		
S/N ratio	(SNR)115 dB		
Line in	Bal input		
Frequency response	10 Hz to 30kHz, +/-3 dB		
THD(THD&N)	0.005% at+4 dBu, 22Hz-20kHz A-weightde		
Max gain	75 dBu MIC INPUT MAIN OUTPUT		
Stereo input channel			
Line in	Bal/unbal		
Frequency response	10 Hz to 55 kHz, +/-3 dB		
THD(THD&N)	0.005% at +4 dBu, 22Hz-20kHz A-weighted		
Impedance			
Mic input	1.4 kOhm		
Line in	10 kOhm		
Other inputs	10 kOhm or more		
Recording output	1 kOhm		
Other outputs	120 Ohm		
Mono EQ			
HI	+/-15 dB @12 kHz		
MID	+/-15 dB @2.5 kHz		
LOW	+/-15 dB @45 Hz		
Low cut filter	80 Hz, 18 dB/Oct.		
Stereo EQ			
HI	+/-15 dB @12 kHz		
LOW	+/-15 dB @60 Hz		
DSP	A/D & D/A converter sample frequency 24-Bit, 16 programs		
Main mix			
Noise (BUS noise)	Fader 0dB, all input channel knobs set to minimum, EQ knobs set to middle, :-100dBu(reference:+4dBu)		
Max output	Bal: +27dBu; unbal: +22dBu 1/4" connector		
	AUX: +22 dBu		
	DSP: +22dBu		
Power supply	100-240 VAC~50/60 Hz		
Dimension(D*W*H)mm	822: 467.5X378.6X152.5	1222: 467.5X491X152.5	1622: 467.5X602.6X152.5
Net weight	822: 5.5Kg	1222: 7Kg	1622: 8.5Kg

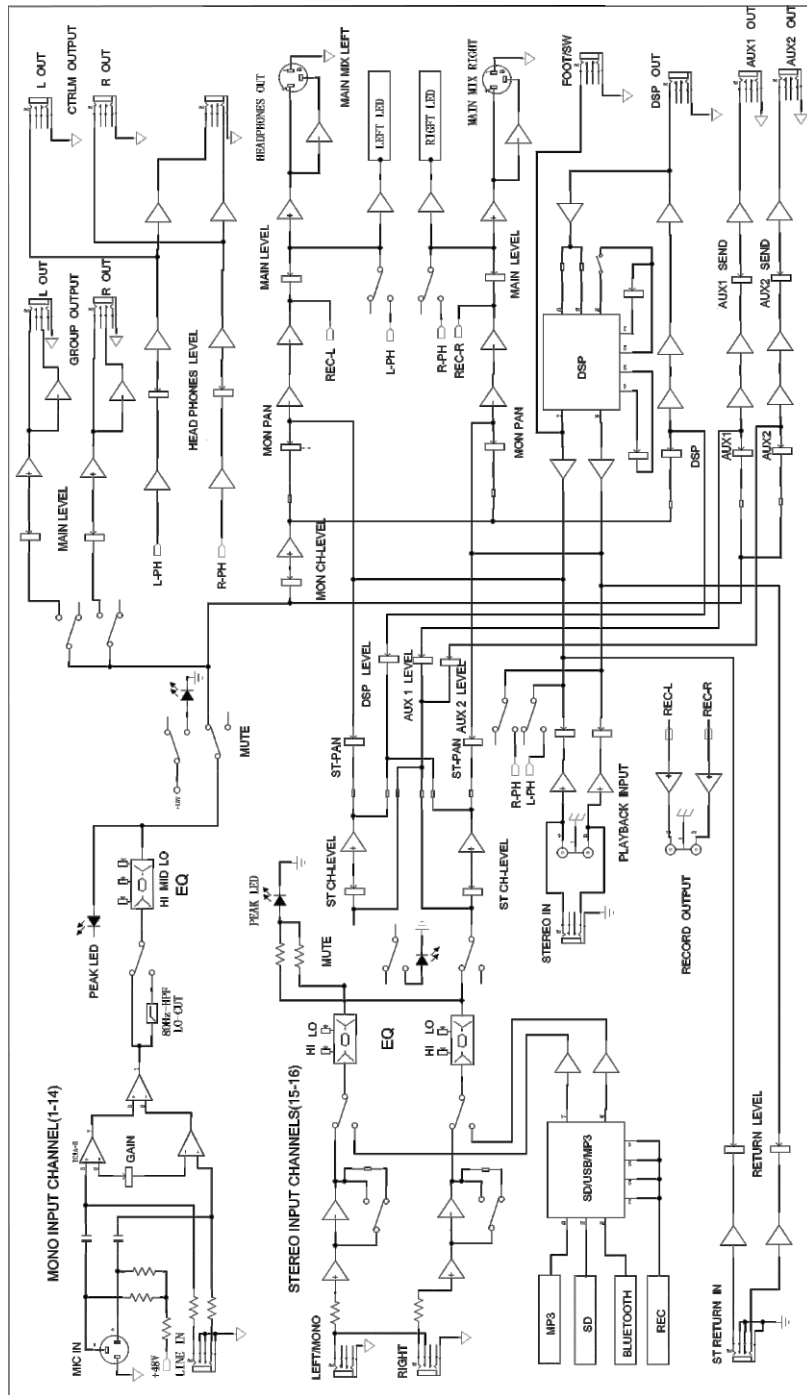

A. Channel

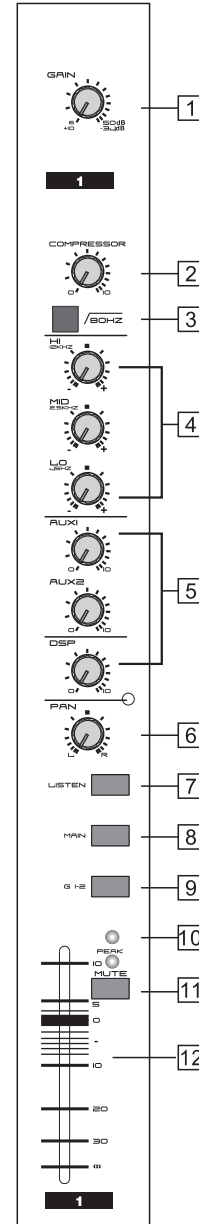

1. Gain control

It adjusts input signal level to balance the S/N ratio and dynamic range. To get best effect, adjust this knob: make PEAK LED flashes sometimes to avoid channel distortion.

Mic input gain range: 6~50dB, line in gain range: +10~ -34.

2. COMP

It adjusts channel compression. Turn clockwise to increase compression ratio and gain will adjust automatically.

3.HPF

It turns on/off the HPF with 18 dB octave to activate 80 Hz LF filter. You can also use it to reduce mains hum noise or stage mic noise.

4. EQ control

Hi when you set it to max, 12KHz frequency level boosts +15dB.

To min, and the 12KHz frequency level cuts -15dB

MID when you set it to max, 2.5KHz frequency level boosts +15dB.

To min, and the 2.5KHz frequency level cuts -15dB.

LOW when you set it to max, 45Hz frequency level boosts +15dB.

To min, and the 45Hz frequency level cuts -15dB

5. AUX-DSP

These four knobs are used to the level of signal sent to AUX-DSP BUS, and then to external DSP, or to built-in DSP module. DSP knob can also adjust channel level.

6. PAN

Set it to middle position, then sound image will be in the middle of the stage. It can also adjust the left/right output signal.

7. LISTEN (Monitor switch)

Press this switch, the input level of this circuit can be detected, and the main indicator light will display the input level

8. MAIN (Master dispatch switch)

If this switch is pressed down, the signal of this circuit can be sent to L / R output.

9. G1-2 (group dispatch switch)

This switch can send the signal of this circuit to G1-2 for output.

10. PEAK LED

When signal reaches the level of clipping level deducted 3dB, PEAK LED lights up red.

11. MUTE & LED

Each channel is designed with MUTE button. Press it to mute the channel. The mute LED lights up.

12. FADER

It adjusts the level of channel signal which is sent to main mix out. Note: set the unused faders to minimum position.

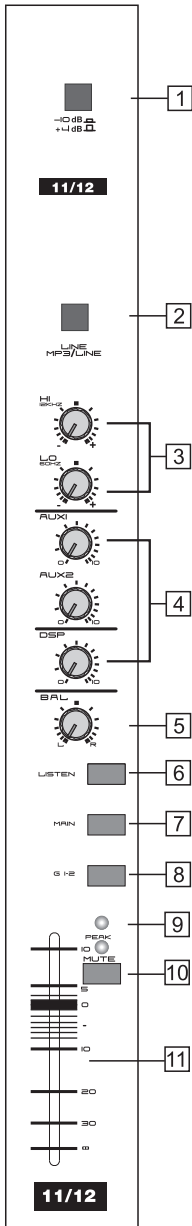

Stereo channel

1. -10/+4 sensitivity switch

Press this switch, this sensitivity will be 10dB higher.

2. LINE/USB/MP3 selection switch

Release for stereo line input. Press for USB/MP3/bluetooth input.

3. EQ control

Hi: set to maximum position, and 12KHz frequency level boosts +15dB. Set to minimum position, and 12KHz frequency level cuts -15dB.

Low: set to maximum position, and 60Hz frequency level boosts +15dB. Set to minimum position, and 60Hz frequency level cuts -15dB.

4. AUX-DSP

These AUX knobs are used to the level of signal sent to AUX-DSP BUS, and then to external DSP, or to built-in DSP module. DSP knob can also adjust channel level.

5. BALANCE (PAN)

Set it to middle position, then sound image will be in the middle of the stage. It can also adjust the left/right output signal.

6. LISTEN (Monitor switch)

Press this switch, the input level of this circuit can be detected, and the main indicator light will display the input level

7. MAIN (Master dispatch switch)

If this switch is pressed down, the signal of this circuit can be sent to L / R output.

8. G1-2 (group dispatch switch)

This switch can send the signal of this circuit to G1-2 for output.

9. PEAK LED

When signal reaches the level of clipping level deducted 3dB, PEAK LED lights up red.

10. MUTE BUTTON & MUTE LED

Each channel is designed with MUTE button. Press it to mute the channel. The mute LED lights up.

11. FADER

It adjusts the channel level.

Note: set the faders of unused channels to minimum position to reduce noise.

Bal/unbal mode of TRS/XLR connectors

1/4 "TRS or XLR connector bal/unbal modes; please refer to below:

1/4 " connector

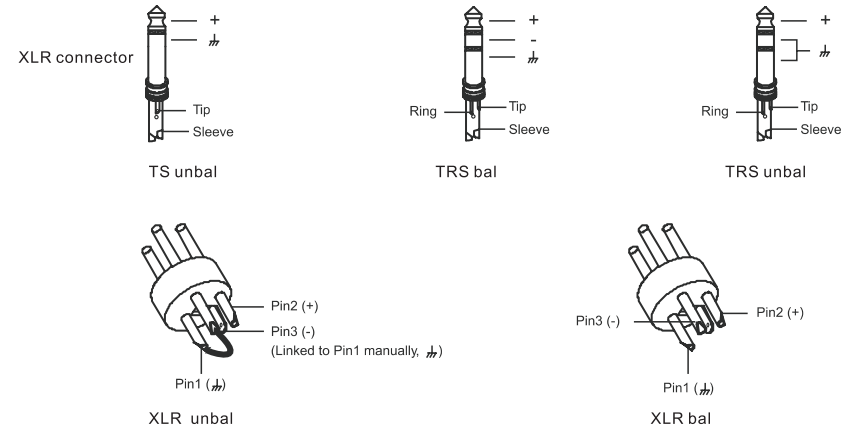

Connection

The supplied 1/4 "TRS and XLR connector to connect with pro audio equipments; please refer to below:

Balanced



Unbalanced



Selecting and playing individual tracks from an USB or SD card.

Press and hold the PLAY/PAUSE button.

Use the forward/back buttons to select the required track.

Release the PLAY/PAUSE button.

Your selected track will now be cue'd and paused and will play when the PLAY/PAUSE button is pressed again.

Useful tips for getting most out of your playback facility during a live performance :

Record a track with no sound on it, say 30 seconds long. Call this track '001 - Silence' and make sure it's always the first track in your file. The reason to do this, is to allow you sufficient time when inserting your memory stick to allow you to enter the play/pause track cueing facility without accidentally playing a track. You can then select the track want leaving the player in PAUSE ready for the performance.

Add a few seconds (up to about 30 seconds) of no sound (quiet) to the end of all of your recorded tracks.

The player will automatically play the next track in sequence if you have multiple tracks, so adding this quiet section to your tracks allows you time to stop your player and cue your next track, to avoid the player going into an unwanted track

Installation

1. There should be no obstacles before the speaker cabinet. You had better put the speaker cabinet on a speaker stand.
2. Use professional devices to suspend or install the speaker cabinets to avoid hurt.
3. Use high quality cable to ensure the best tone.
4. Please match the right power and impedance of power amplifier and speaker cabinet.
5. Do not point the microphone to the speaker cabinet to avoid feedback.

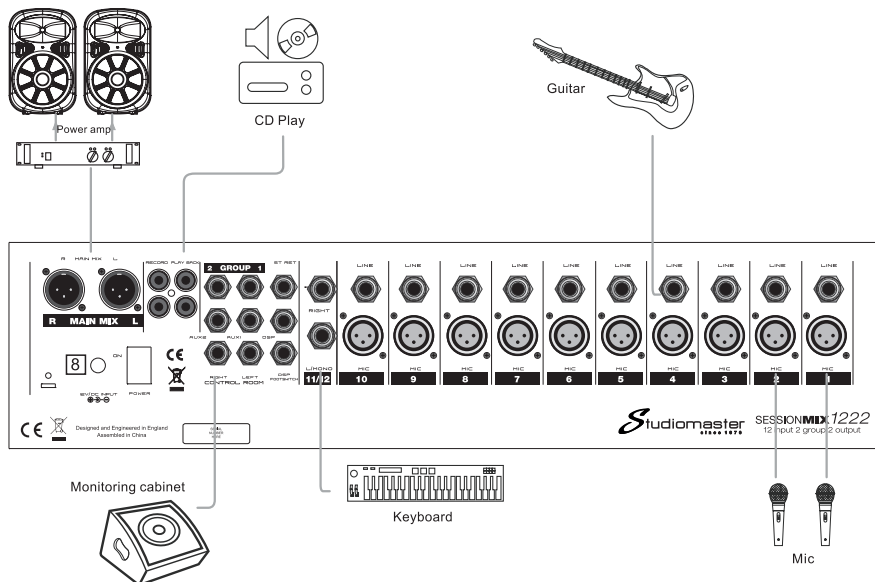

OUTPUT AND REAR PANEL

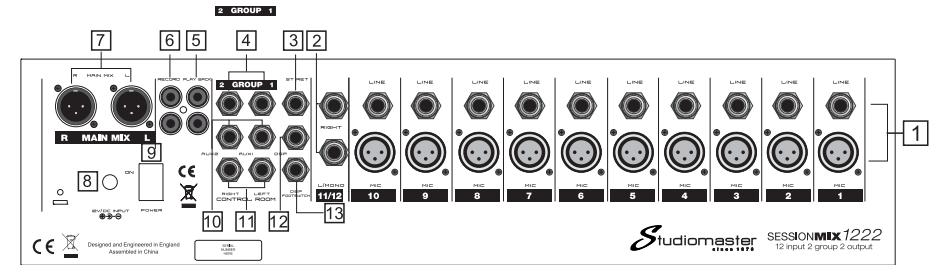

1. MIC/LINE CHANNEL (CH1-6)

SESSIONMIX 822 is designed with 6 low noise mic pre-amp (SESSIONMIX 1222 has 10) and phantom power, 45dB gain and >100 dB S/N ratio. The phantom power is used for condenser mic. If you use dynamic mic, please turn off phantom power first. These channels are designed with 1/4 inch TRS bal/unbal line in connectors to connect with keyboard, electric drum, DSP, etc.

2. Stereo channel input

Unbalanced connectors. If signal input from LEFT/MONO, the signal outputs from L/R main mix outputs. If signal inputs from RIGHT connector, signal outputs from R main mix output. This connector can be connected with keyboard, electric drum, DSP, etc.

3. AUX RETURNS input

Stereo 1/4" phone jacks to return effect stereo signal to Main Mix. Or you can use AUX RETURN knob to adjust volume. The input AUX signal will be sent to MAIN MIX.

4. GROUP1-2 output

The 1/4" phone jacks can send signals from channel G1-2 to external devices. The signal can be controlled by the grouped faders.

5. PLAYBACK

Unbal RCA and 3.5 connectors to input signal from CD player/computer, etc;

6. RECORD

7. MAIN MIX output

Bal XLR connector. The level is adjusted by Main Mix fader.

8. Power supply socket

Insert adapter DC12V

9. POWER socket

It is designed with fuse to connect with mains. Please replace the fuse with the same type and rating.

10. AUX SENDS output

1/4" phone jacks are used to send signals from the AUX bus to external devices, such as effects devices or stage monitors.

11. CTRL ROOM output

1/4" phone jacks to send control room signals to the studio monitoring speakers.

12. DSP output

1/4" phone jack to output DSP signal and the level is controlled by channel DSP.

13. DSP FOOTSWITCH socket

1/4" phone jack can be connected to an external foot switch to control the effect signal.

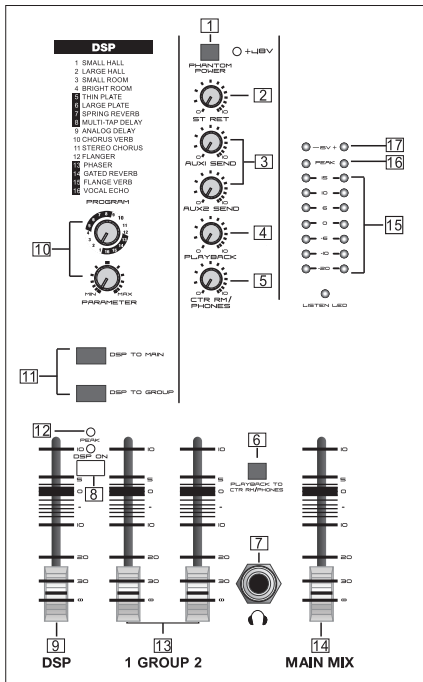

1. +48V phantom power switch/red when on
It is used for condenser mic . Please set all faders to minimum before turning on the switch to protect speaker cabinets.

2. Stereo return
It adjusts stereo return signal level.

3. AUX send
It adjusts aux send level.

4. PLAYBACK
It adjusts the playback signal level.

5. CTRLMP PHONES
It adjusts the phone signal level.

6. PLAYBACK switch
Press the switch to send signal to monitor and phones.

7. Phone output
This connector send signal to phones.

8. DSP ON switch
Press this switch to start DSP operation and LED lights up green.

9. DSP fader
It adjusts the DSP signal level.

10. PARAMETER control and EFFECT (16 effects)
It adjusts the delay time.

11. DSP TO MAIN and GROUP
Press the switch to send the effect to the main output and group output

15. MAIN OUTPUT LEVEL LED

16. PEAK LED

17. POWER LED

12. EFFECT PEAK LED

13. GROUP fader
It adjusts the group output level.

14. MAIN MIX fader
It adjusts the MAIN MIX output level.

Prg#	Description	Parameter 1
1	Small Hall	Rev Time 0.9sec~3.5sec
2	Large Hall	Rev Time 1.5sec~8.6sec
3	Small Room	Rev Time 0.28sec~0.82sec
4	Bright Room	Rev Time 0.36sec~1.38sec
5	Thin Plate	Rev Time 0.44sec~1.54sec
6	Large Plate	Rev Time 0.72sec~10sec
7	Spring Reverb	Rev Time 0.4sec~2.3sec
8	Multi-tap Delay	Delay Time 0~680ms
9	Analog Delay	Delay Time 0~680ms
10	Chorus Verb	Rev Time 0.56sec~3.5sec
11	STEREO CHORUS	Rate 0.58Hz~6Hz
12	Flanger	Rate 0.58Hz~4.35Hz
13	Phaser	Rate 0.58Hz~11Hz
14	Gated Reverb	Gate Time 0.25sec~0.78sec
15	Flange Verb	Rev Time 0.34sec~2sec
16	Vocal Echo	Delay Time 0~400ms

SD/USB/BLUETOOTH

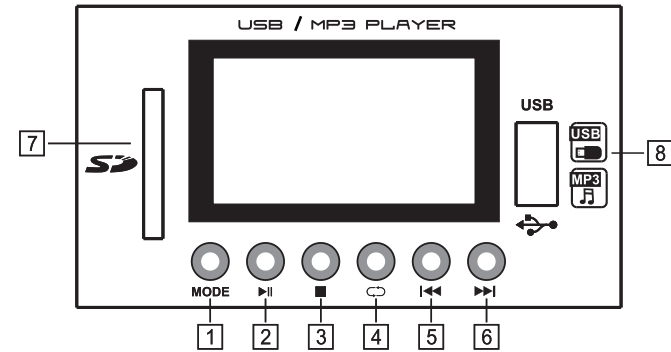

1. MODE

Press this button to select mode: SD card, USB, bluetooth, recording.

a) SD/USB mode: insert SD card/USB to play music directly.

b) Bluetooth mode: press the button to select bluetooth, then match the bluetooth, then play music.

c) Recording mode: press the button to select recording mode.

Mixed signals from both MIC and LINE press play button to record.

The LCD displays recording symbol flashing.

2. Play/pause button

3. Stop button

4. Repeat button

5. Previous button

6. Next button

7. Sd card connector for playback and recording

8. USB interface to connect with PC for playback and recording

SD card/USB details

Loop Functions

1 = play one chosen track on loop (repeat) Note in this mode recorded tracks cannot be selected.

F = play all tracks within same folder on your SD card or USB drive in sequence on loop (repeat).

R = shuffle - plays all tracks randomly no loop (no repeat)

A = plays all tracks in sequence on loop (repeat)