

THRASH212

THRASH215

1300W Powered Loudspeakers

OWNER'S MANUAL

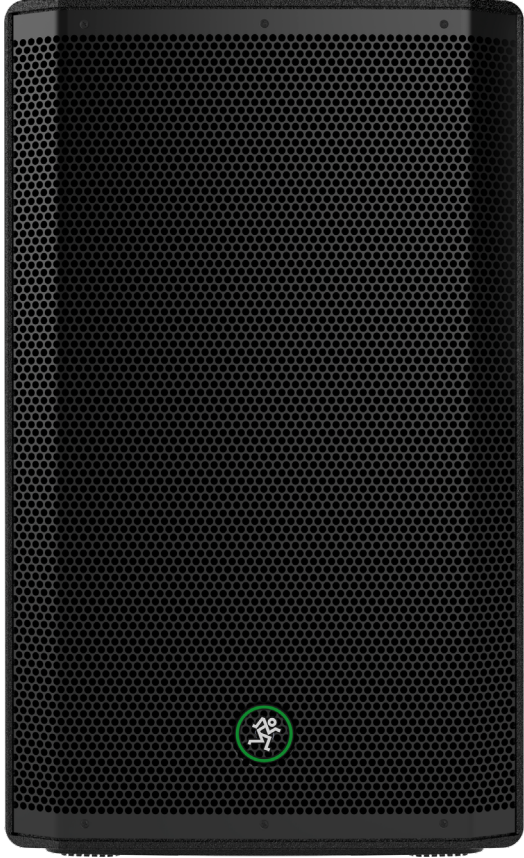
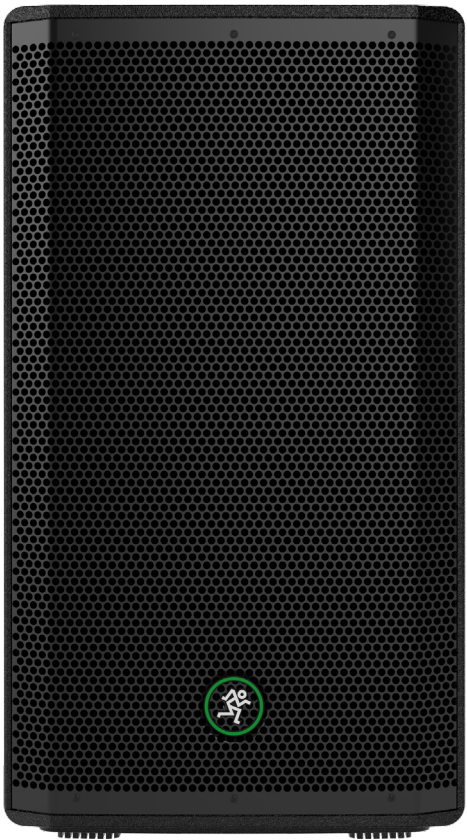

Important Safety Instructions

1. Read these instructions.
2. Keep these instructions.
3. Heed all warnings.
4. Follow all instructions.
5. Do not use this apparatus near water.
6. Clean only with a dry cloth.
7. Do not block any ventilation openings. Install in accordance with the manufacturer's instructions.
8. Do not install near any heat sources such as radiators, heat registers, stoves, or other apparatus (including amplifiers) that produce heat.
9. Do not defeat the safety purpose of the polarized or grounding-type plug. A polarized plug has two blades with one wider than the other. A grounding-type plug has two blades and a third grounding prong. The wide blade or the third prong are provided for your safety. If the provided plug does not fit into your outlet, consult an electrician for replacement of the obsolete outlet.
10. Protect the power cord from being walked on or pinched particularly at plugs, convenience receptacles, and the point where they exit from the apparatus.
11. Only use attachments/accessories specified by the manufacturer.
12. Use only with a cart, stand, tripod, bracket, or table specified by the manufacturer, or sold with the apparatus. When a cart is used, use caution when moving the cart/apparatus combination to avoid injury from tip-over.
13. Unplug this apparatus during lightning storms or when unused for long periods of time.
14. Refer all servicing to qualified service personnel. Servicing is required when the apparatus has been damaged in any way, such as power-supply cord or plug is damaged, liquid has been spilled or objects have fallen into the apparatus, the apparatus has been exposed to rain or moisture, does not operate normally, or has been dropped.
15. This apparatus shall not be exposed to dripping or splashing, and no object filled with liquids, such as vases or beer glasses, shall be placed on the apparatus.
16. Do not overload wall outlets and extension cords as this can result in a risk of fire or electric shock.



17. **NOTE:** This equipment has been tested and found to comply with the limits for a Class A digital device, pursuant to part 15 of the FCC Rules. These limits are designed to provide reasonable protection against harmful interference when the equipment is operated in a commercial environment. This equipment generates, uses, and can radiate radio frequency energy and, if not installed and used in accordance with the instruction manual, may cause harmful interference to radio communications. Operation of this equipment in a residential area is likely to cause harmful interference in which case the user will be required to correct the interference at his own expense.

WARNING: Operation of THRASH in a residential environment could cause radio interference.

CAUTION: Changes or modifications to this device not expressly approved by LOUD Audio, LLC could void the user's authority to operate the equipment under FCC rules.

18.  This apparatus has been designed with Class-I construction and must be connected to a mains socket outlet with a protective earthing connection (the third grounding prong).
19. This apparatus has been equipped with a rocker-style AC mains power switch. This switch is located on the rear panel and should remain readily accessible to the user.
20. The MAINS plug or an appliance coupler is used as the disconnect device, so the disconnect device shall remain readily operable.

25. This apparatus does not exceed the Class A/Class B (whichever is applicable) limits for radio noise emissions from digital apparatus as set out in the radio interference regulations of the Canadian Department of Communications.

ATTENTION — *Le présent appareil numérique n'émet pas de bruits radioélectriques dépassant les limites applicables aux appareils numériques de class A/de class B (selon le cas) prescrites dans le règlement sur le brouillage radioélectrique édicté par les ministere des communications du Canada.*

26. Exposure to extremely high noise levels may cause permanent hearing loss. Individuals vary considerably in susceptibility to noise-induced hearing loss, but nearly everyone will lose some hearing if exposed to sufficiently intense noise for a period of time. The U.S. Government's Occupational Safety and Health Administration (OSHA) has specified the permissible noise level exposures shown in the following chart.

According to OSHA, any exposure in excess of these permissible limits could result in some hearing loss. To ensure against potentially dangerous exposure to high sound pressure levels, it is recommended that all persons exposed to equipment capable of producing high sound pressure levels use hearing protectors while the equipment is in operation. Ear plugs or protectors in the ear canals or over the ears must be worn when operating the equipment in order to prevent permanent hearing loss if exposure is in excess of the limits set forth here:

Duration, per day in hours	Sound Level dBA, Slow Response	Typical Example
8	90	Duo in small club
6	92	
4	95	Subway Train
3	97	
2	100	Very loud classical music
1.5	102	
1	105	The dogs barking at the mailman
0.5	110	
0.25 or less	115	Loudest parts at a rock concert





CAUTION

RISK OF ELECTRIC SHOCK! DO NOT OPEN!



CAUTION: TO REDUCE THE RISK OF ELECTRIC SHOCK DO NOT REMOVE COVER (OR BACK). NO USER-SERVICEABLE PARTS INSIDE. REFER SERVICING TO QUALIFIED PERSONNEL.

 The lightning flash with arrowhead symbol within an equilateral triangle is intended to alert the user to the presence of uninsulated "dangerous voltage" within the product's enclosure, that may be of significant magnitude to constitute a risk of electric shock to persons.

 The exclamation point within an equilateral triangle is intended to alert the user of the presence of important operating and maintaining (servicing) instructions in the literature accompanying the appliance.

WARNING — To reduce the risk of fire or electric shock, do not expose this apparatus to rain or moisture.

CAUTION — To prevent electric shock hazard, do not connect to mains power supply while grille is removed.

Laite on liitettävä suojakoskettimilla varustettuun pistorasiaan.

Apparatet stikprop skal tilsluttes en stikkontakt med jord, som giver forbindelse til stikproppens jord.

Apparatet må tilkoples jordet stikkontakt.

Apparaten skall anslutas till jordat uttag.



Correct disposal of this product: This symbol indicates that this product should not be disposed of with your household waste, according to the WEEE directive (2012/19/EU) and your national law. This product should be handed over to an authorized collection site for recycling waste electrical and electronic equipment (EEE). Improper handling of this type of waste could have a possible negative impact on the environment and human health due to potentially hazardous substances that are generally associated with EEE. At the same time, your cooperation in the correct disposal of this product will contribute to the effective usage of natural resources. For more information about where you can drop off your waste equipment for recycling, please contact your local city office, waste authority, or your household waste disposal service.

Contents

Important Safety Instructions 2

Contents 3

Features 3

Introduction 4

Getting Started 4

Hookup Diagrams 5

Thrash Loudspeakers: Rear Panel Features... 10

 1. Power Connection 10

 2. Power Switch 10

 3. XLR and 1/4" Combo Input Jacks 10

 4. Gain Knobs 11

 5. Mix Out Jack 11

 6. Spigot / Knobs 11

 7. Main Volume Knob 11

 8. Power / Overload LED 11

Protection Circuitry 12

 Limiting 12

 Overexcursion Protection 12

 Thermal Protection 12

AC Power 12

Care and Maintenance 12

Placement 13

 Room Acoustics 13

Appendix A: Service Information 14

Appendix B: Technical Information 15

Thrash Block Diagram 16

Limited Warranty 17

Features

1300W ultra-efficient Class-D amplifier

Built-Like-A-Tank™ to conquer every gig while lightweight for easy loading

Frequency response: 52 Hz – 20 kHz (-10 dB) [Thrash212]

Frequency response: 38 Hz – 20 kHz (-10 dB) [Thrash215]

Max SPL: 125 dB [Thrash212]

Max SPL: 126 dB [Thrash215]

Flexible I/O

- Inputs 1 and 2 feature XLR/TRS combo inputs
- Inputs accept both line and mic level
- Mix output contains audio from both input channels

12" high-performance woofer [Thrash212]

15" high-performance woofer [Thrash215]

1" Titanium compression driver

Standard pole mount

Equipped with 4 handles for easy loading

Dual-angle monitor wedge for use as a floor monitor

Rotatable grille badge



Introduction

Mackie Thrash loudspeakers are all about no frills, raw power, and reliability without sacrificing sound quality.

Built on a legacy of legendary loudspeaker design, Thrash is voiced for modern musicians, loud vocals, screaming guitars, and face-melting keytar solos.

With a wall-shaking 1300W of power, Thrash has what it takes to keep up with every gig, rehearsal, you name it.

Flexible I/O includes two inputs plus a Mix Out for chaining speakers or hooking up a powered subwoofer.

Thrash is the ultimate start to building your own gig-worthy PA system, so throw it in the van and let's do this.

How to Use This Manual:

After this introduction, a getting started guide will help you get things set up fast. The hookup diagrams show some typical Thrash loudspeaker setups.



This icon marks information that is critically important or unique! For your own good, read and remember them...it is a good idea to pay special attention to these areas in the Owner's Manual marked with the "VERY IMPORTANT" hand icon.



There's an illustration of a microscope, so, of course, you're going to get more detailed information when you see this little guy. There are explanations of features and practical tips listed here.



It's a good idea to pay attention to text displayed next to a note icon, as this icon draws attention to certain features and functions relating to the usage of the Thrash Series.

Please write the serial numbers here for future reference (i.e., insurance claims, tech support, return authorization, make dad proud, etc.)

Purchased at:

Date of purchase:

Getting Started

The following steps will help you set up the loudspeakers quickly.

1. Make all initial connections with the power switches OFF on all equipment. Make sure the master volume, level and gain controls are all the way down.
2. If not using a subwoofer, connect the outputs from the mixing console (or other signal source) to the inputs on the rear panel of the loudspeakers.
3. If using a subwoofer, connect the outputs from the mixing console (or other signal source) to the inputs on the subwoofer, then connect the high pass outputs from the subwoofer to the inputs of the loudspeakers.
4. Push the line cord securely into the subwoofer's / loudspeaker's IEC connectors and plug the other ends into grounded AC outlets. The subwoofer/loudspeaker may accept the appropriate voltage as indicated near the IEC connector.
5. Turn the mixer (or other signal source) on.
6. Turn the subwoofer on (if applicable).
7. Turn the loudspeakers on.
8. Make sure the loudspeaker's channel gain knob(s) are set to mic or line.
9. Be sure that the volume of the input is the same as it would be during normal use.
10. Start the signal source and raise the mixer's main L/R fader up to a comfortably loud listening level.

Things to Remember:

- Never listen to loud music for prolonged periods. Please see the Safety Instructions on page 2 for information on hearing protection.
- As a general guide, the mixer (or other signal source) should be turned on first, subwoofers next, and Thrash loudspeakers last. As such, the Thrash loudspeakers should also be turned off first, followed by the subwoofers, then the mixer. This will reduce the possibility of any turn-on or turn-off thumps and other noises generated by any upstream equipment from coming out of the speakers.
- Save the shipping boxes and packing materials! You may need them someday. Besides, the cats will love playing in them and jumping out at you unexpectedly. Remember to pretend like you are surprised!
- Save your sales receipt in a safe place.

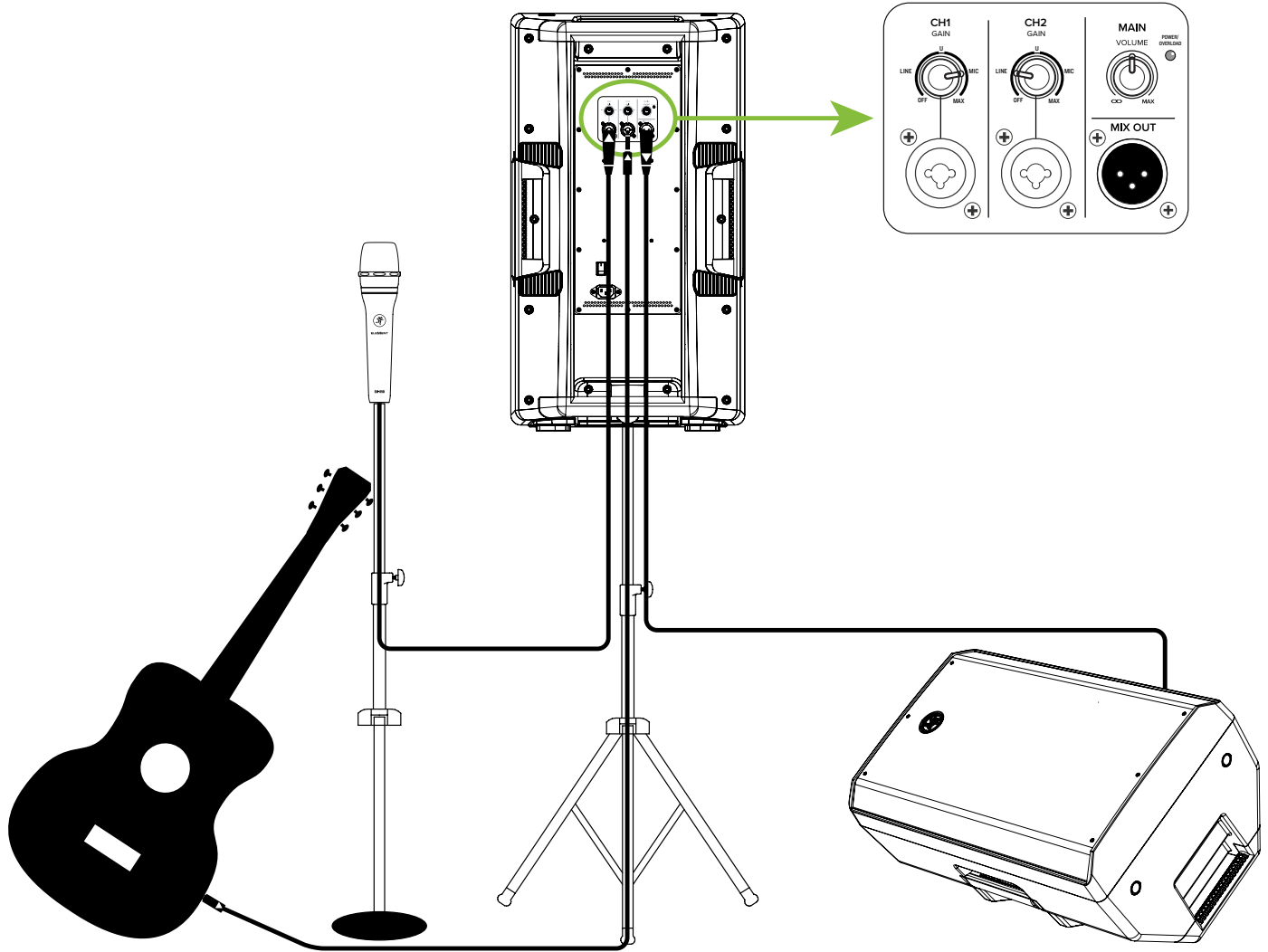

Thrash loudspeakers are the perfect tool for singer-songwriters touring the local coffee shops. Bring your favorite axe and mic, Thrash loudspeakers and cables and power cords.

In this example, a Mackie EM-89D microphone is connected to the channel 1 input of a Thrash loudspeaker, used as the main PA. Note that the gain knob is set to Mic.

Now grab your axe and plug it directly into the channel 2 input. Or if you use effects, connect the guitar to the effects input and another cable from the effects output to the channel 2 input. Note that the gain knob is set to Line.

An additional Thrash loudspeaker will be used for monitoring purposes. Simply connect a cable from the Thrash PA's MIX OUT jack to the Thrash monitor's channel 1 input. This gain knob should also be set to Line.

Keep in mind that these "MIC" and "LINE" markings are for reference only and may need to be raised or lowered.

Singer-Songwriter Setup

Hookup Diagrams continued...

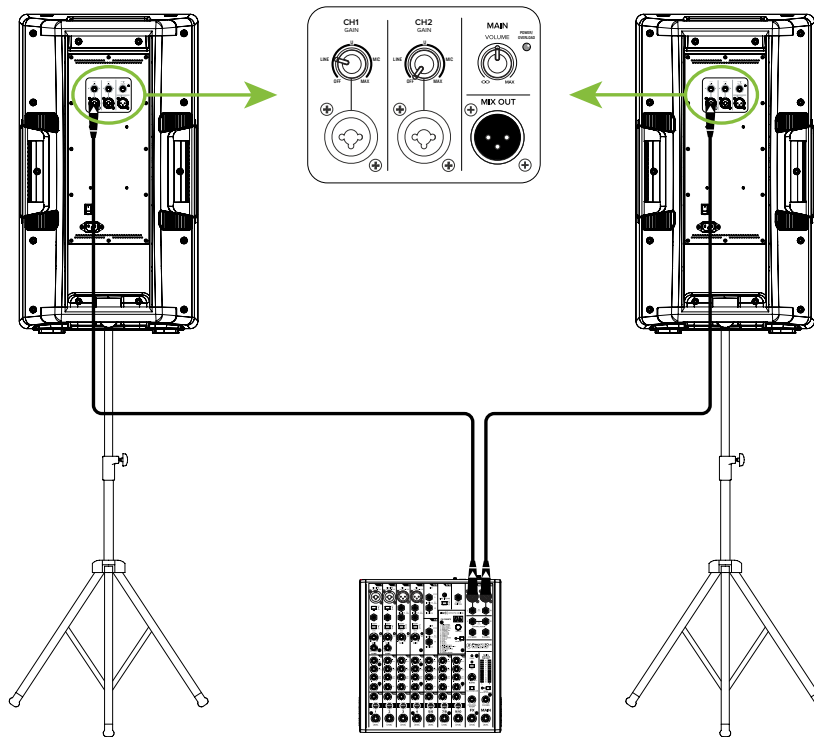

In this example, a ProFX10v3 mixer is connected directly to two Thrash loudspeakers. It is the perfect setup for a small club or... a fun karaoke house party! Simply connect the L/R outputs of the ProFX10v3 mixer to the channel 1 input of each Thrash loudspeaker. The gain knob on both should be set to Line. Keep in mind that these “MIC” and “LINE” markings are for reference only and may need to be raised or lowered.

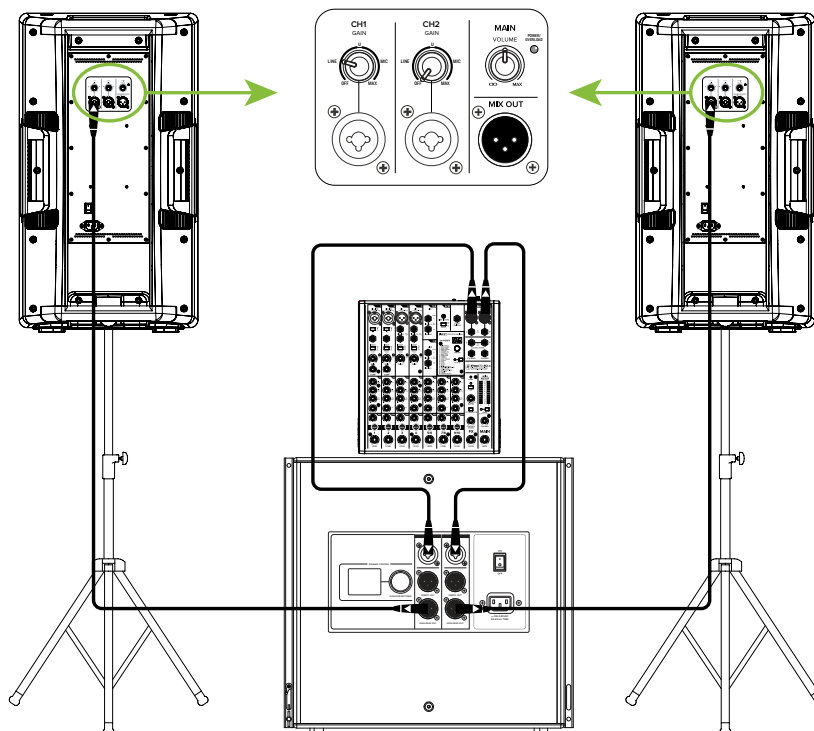

If you desire a little more boom, add a DRM18S subwoofer to the mix. Here, the L/R outputs of a ProFX10v3 mixer are connected directly to the channel 1 and 2 inputs of the DRM18S subwoofer. Then the High-Pass Outs of the subwoofer are connected to the channel 1 inputs of a pair of Thrash loudspeakers. The gain knob on both should be set to Line. Keep in mind that these “MIC” and “LINE” markings are for reference only and may need to be raised or lowered.

Small Club System

Hookup Diagrams continued...

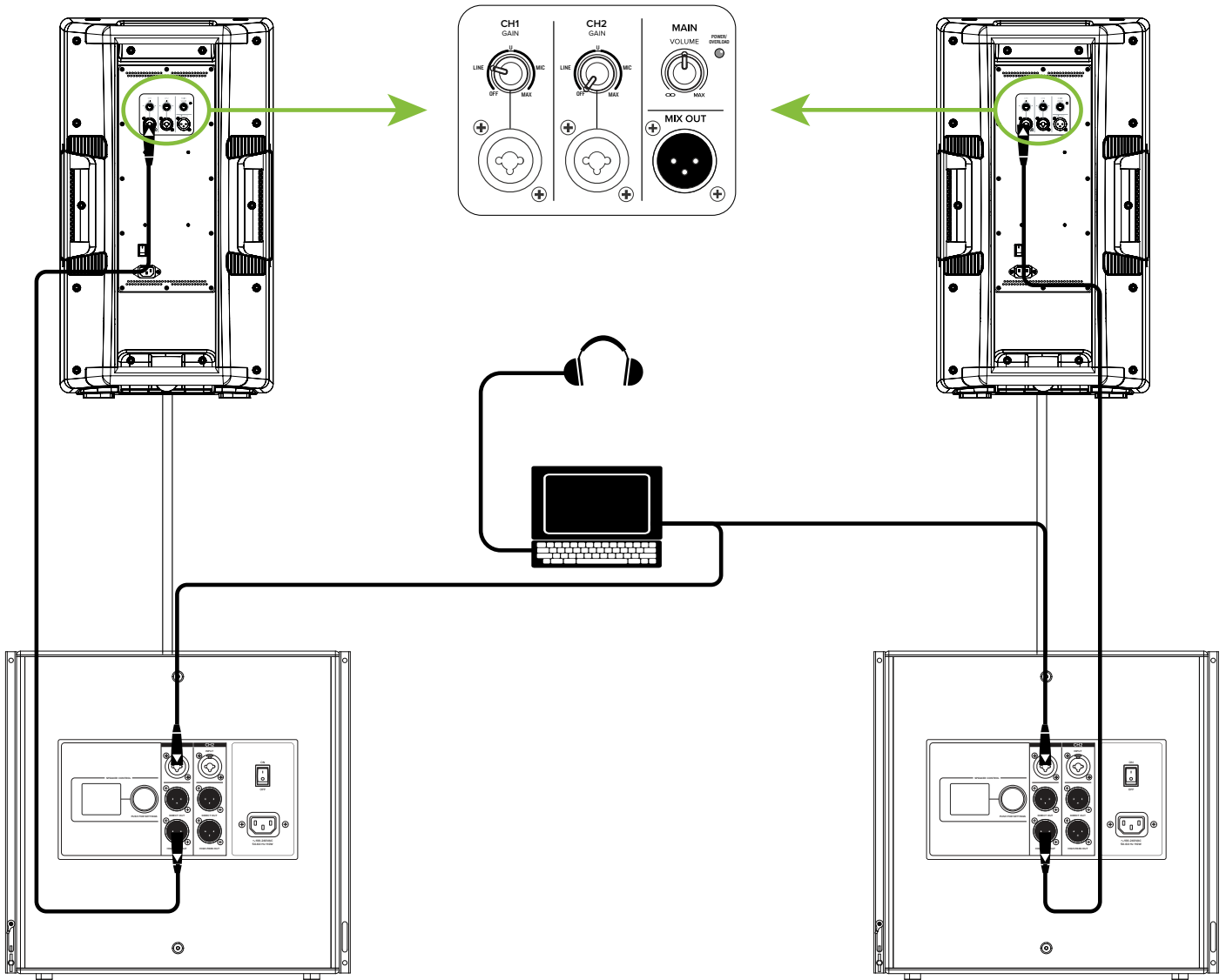

Perhaps you're a DJ playing bumpin' tunes in the middle of the night to a crowd that's groovin' and dancin' to your fine selection. Then it's time to bring out the big guns!

In this example, a laptop is connected to the inputs of two DRM18S subwoofers.

The High-Pass Out of each subwoofer is then connected to the input of each Thrash loudspeaker. The gain knob on both should be set to Line. Keep in mind that these "MIC" and "LINE" markings are for reference only and may need to be raised or lowered. Additionally, a set of Mackie MC-450 headphones is connected to the phones jack of the laptop.

Hookup Diagrams continued...

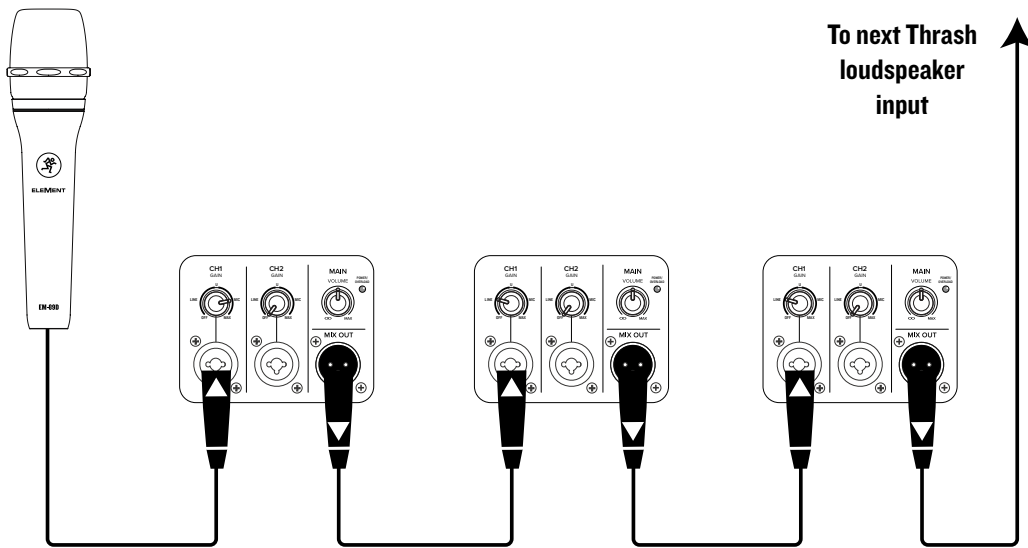
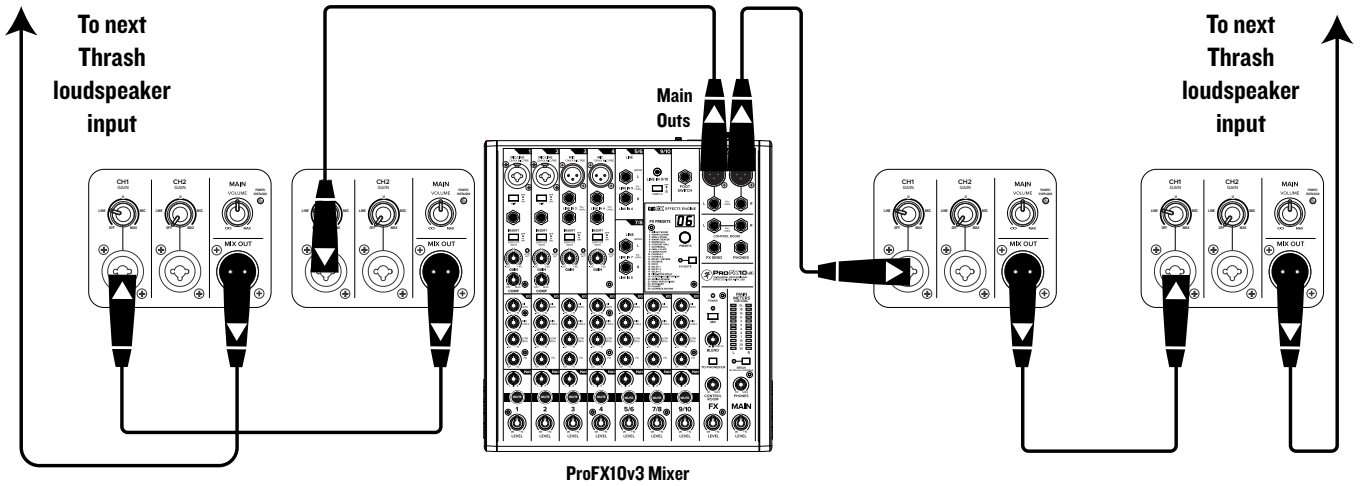

Thrash loudspeakers may be daisy-chained via the “MIX OUT” jack which outputs all inputs. Simply plug the signal source (i.e., mixer output or microphone) into the input jack(s), and patch that loudspeaker’s mix out jack to the next loudspeaker’s input jack, and so on, daisy-chaining multiple Thrash loudspeakers. See above for visual representations of daisy-chaining.

NOTE: Make sure to set the gain knob(s) correctly. In the top diagram, all input channels are set to “LINE” and in the bottom diagram, input channel 1 of the first Thrash is set to “MIC”, but the remaining ones should be set to “LINE”. Keep in mind that these “MIC” and “LINE” markings are for reference only and may need to be raised or lowered.

Daisy-Chaining Multiple Thrash Loudspeakers

Hookup Diagrams continued...

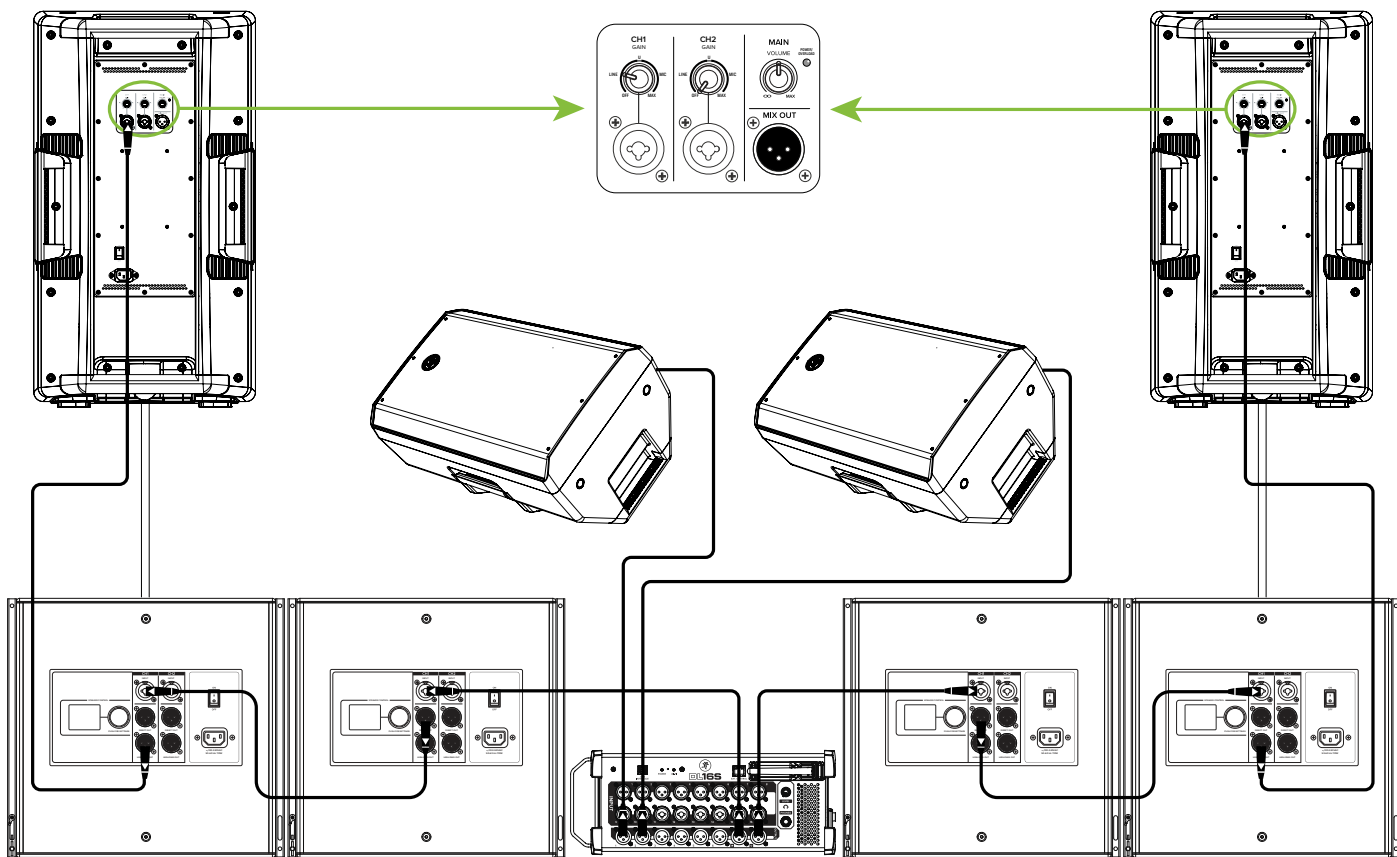

Here's how to set up a large club system. In this example, the L/R outputs of a DL16S mixer are connected directly to the channel 1 inputs of a pair of DRM18S subwoofers. The Direct Out of each subwoofer is then connected to the inputs of an additional pair of DRM18S subwoofers.

From here, the high-pass outputs of the two outer DRM18S subwoofers are connected directly to the inputs of a set of Thrash loudspeakers. Talk about beefy low end!

Outputs 1 and 2 from the mixer may be used as aux sends; these are connected directly to the channel 1 inputs of a pair of Thrash loudspeakers to be used as monitors for the band. The gain knob on all Thrash loudspeakers in this example should be set to Line. Keep in mind that these "MIC" and "LINE" markings are for reference only and may need to be raised or lowered.

Large Club System

Thrash Series Loudspeakers: Rear Panel Features

1. Power Connection

This is a standard 3-prong IEC power connector. Connect the detachable power cord (included in the packaging with the loudspeaker) to the power receptacle, and plug the other end of the power cord into an AC outlet.



Make sure that the AC power is matched to the AC power indicated on the rear panel (near the IEC receptacle).



Disconnecting the plug's ground pin is dangerous. Don't do it!

2. Power Switch

Press the top of this rocker switch inwards to turn on the loudspeaker. Press the bottom of this rocker switch inwards to turn off the loudspeaker.



As a general guide, the mixer (or other signal source) should be turned on first, subwoofers next, and loudspeakers last.

As such, the loudspeakers should also be turned off first, followed by the subwoofers, then the mixer. This will reduce the possibility of any turn-on or turn-off thumps and other noises generated by any upstream equipment from coming out of the speakers.

3. XLR and 1/4" Combo Input Jacks

Input channels 1 and 2 may accept a balanced mic signal using an XLR connector. They are wired as follows, according to standards specified by the AES (Audio Engineering Society).

XLR Balanced Wiring:

- Pin 1 = Shield (ground)
- Pin 2 = Positive (+ or hot)
- Pin 3 = Negative (- or cold)

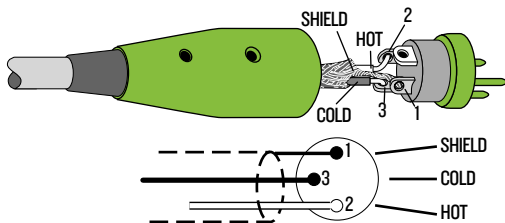

In addition to accepting a balanced mic signal using an XLR connector, these input channels may also accept 1/4" line-level signals driven by balanced or unbalanced sources.

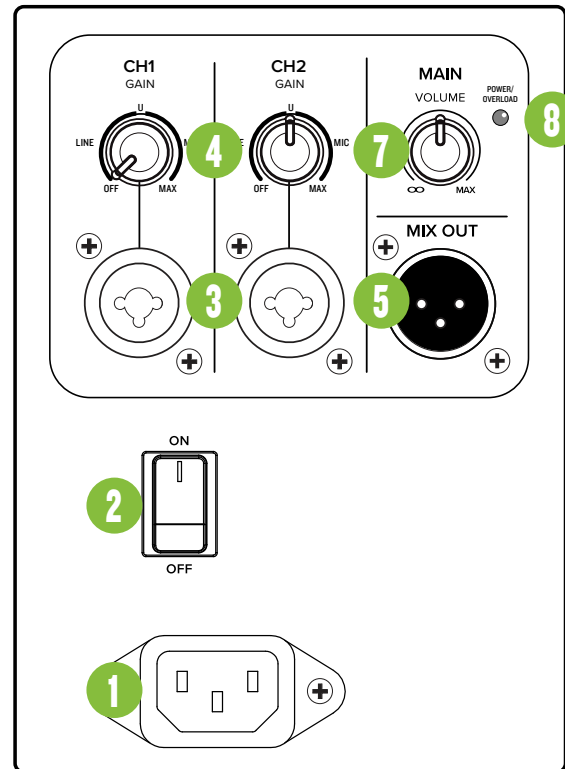

To connect balanced lines to these inputs, use a 1/4" Tip-Ring-Sleeve (TRS) plug. "TRS" stands for Tip-Ring-Sleeve, the three connection points available on a stereo 1/4" or balanced phone jack or plug. TRS jacks and plugs are used for balanced signals and are wired as follows:

1/4" TRS Balanced Mono Wiring:

- Sleeve = Shield
- Tip = Hot (+)
- Ring = Cold (-)

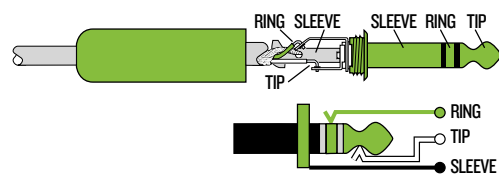

To connect unbalanced lines to these inputs, use a 1/4" mono (TS) phone plug, wired as follows:

1/4" TS Unbalanced Mono Wiring:

- Sleeve = Shield
- Tip = Hot (+)

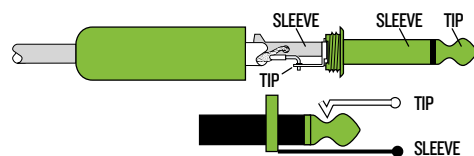

NEVER connect the output of an amplifier directly to a Thrash input jack. This could damage the input circuitry!

Thrash Series Loudspeakers: Rear Panel Features continued...

4. Gain Knobs

The gain knobs adjust the input sensitivity of the mic/line inputs. This allows signals from the outside world to be adjusted to run through each channel at optimal internal operating levels.

It ranges from off (knob fully down) up to max (knob fully up).



If connecting mixer outputs to loudspeaker inputs, set the gain knob to 9:00 [“LINE”] for optimal sound and performance.

5. Mix Out Jack

This is a male XLR-type connector that produces the mix from the input jacks. Use it to daisy-chain several Thrash loudspeakers together off the same signal source(s).

They are wired as follows, according to standards specified by the AES (Audio Engineering Society):

Balanced XLR Output Connector

- Pin 1 – Shield (ground)
- Pin 2 – Positive (+ or hot)
- Pin 3 – Negative (- or cold)

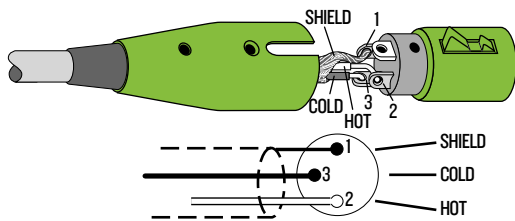

See page 8 to learn more about daisy-chaining Thrash loudspeakers.

6. Spigot / Knobs

Thrash loudspeakers can pull double-duty as both a loudspeaker and a cooler that can hold two different types of beverages. At the top of each loudspeaker are two screw-on/off caps. Remove the caps by rotating them counter-clockwise.

Next, pour a beverage into each open hole; this can be the same thing in both or something totally different! Be sure not to overpour. Now just replace the caps by rotating them clockwise.

The accompanying knobs act as the spigot from off (knob fully counter-clockwise) to full blast (knob fully clockwise).



These knobs should always be in the off position unless pouring a beverage.¹

¹ Now, if you really poured a beverage (or beverages) in, on or over the Thrash loudspeaker, your warranty is DEFINITELY voided. But how cool would it be to go glamping, to your kid's game, host a BBQ, etc. with a dual purpose product?

7. Main Volume Knob

The level knob adjusts the overall signal level at the input to the built-in power amplifiers. It ranges from Off ($-\infty$) to MAX (maximum gain).

- Thrash loudspeakers are designed to operate with a +4 dBu signal when the main knob is at the center position.

- Thrash loudspeakers may accept up to a +20 dBu signal by turning down the main knob accordingly.

- Turning the main knob past center position will provide enough gain to connect a microphone directly. Most microphones will want the knob somewhere around the 9:00 position. For safety, if you're plugging in a mic, start with the volume off and gradually rotate it clockwise until you achieve the desired volume... and be on the lookout for the dreaded shriek of the feedback monster.

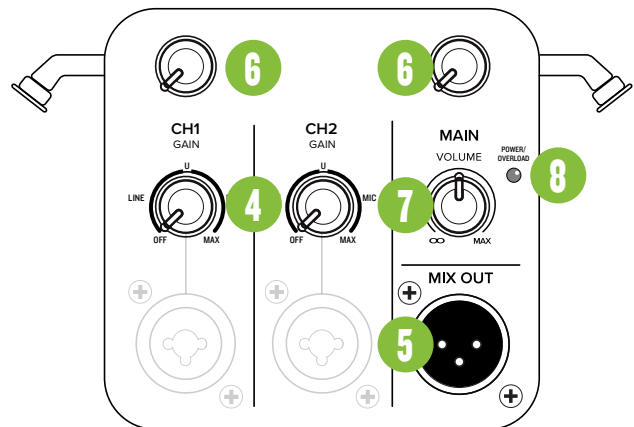

8. Power / Overload LED

This dual-colored LED will illuminate green when the loudspeaker is turned on, as a reminder of how on it really is. If it is not on, then it is off, and the loudspeaker becomes a rather nice weight for keeping your morning newspaper from blowing away in the wind.

If it does not turn on, make sure the power cord is correctly inserted at both ends, the local AC mains supply is active and the power switch is on.

Thrash loudspeakers also have a built-in limiter that helps to prevent the amplifier outputs from clipping or overdriving the transducers. The LED illuminates red when the limiter is activated. If this occurs, turn down the gain knob.



Excessive limiting may lead to overheating, which in turn trips the thermal protect circuitry and interrupts the performance.

See 'Thermal Protection' on the following page for more information.

Protection Circuitry

Thrash loudspeakers employ a built-in limiter for less distortion at peak levels. A dynamic bass response circuit provides optimal low frequency response regardless of overall output level. Additional protection includes automatic thermal shutdown should the amp overheat. However, with Class-D amp technology, which is highly-efficient, this should never be a problem.



The protection circuits are designed to protect the loudspeakers under reasonable and sensible conditions. Should you choose to ignore the warning signs [e.g. excessive distortion], you can still damage the woofer in the loudspeaker by overdriving it past the point of amplifier clipping. Such damage is beyond the scope of the warranty.

Limiting

The titanium high frequency driver has its own compression circuit which helps protect it from damaging transient peaks. The compressor is designed to be transparent and is not noticeable under normal operating conditions.

Overexcursion Protection

A subsonic filter circuit just prior to the power amplifier prevents ultra-low frequencies from being amplified. Excessive low-frequency energy can damage the woofer by causing it to “bottom out,” also known as overexcursion, which is equivalent to a mechanical form of clipping.

Thermal Protection

All amplifiers produce heat. Thrash loudspeakers are designed to be efficient both electrically and thermally. In the unlikely event of the amplifier overheating, a built-in thermal switch will activate, muting the signal.

When the amplifier has cooled down to a safe operating temperature, the thermal switch resets itself, and the Thrash loudspeaker resumes normal operation.

If the thermal switch activates, try turning down the level control a notch or two on the mixing console to avoid overheating the amplifier. Be aware that direct sunlight and/or hot stage lights may be the culprit of an amplifier overheating.

AC Power

Be sure the Thrash loudspeaker is plugged into an outlet that is able to supply the correct voltage specified for your model. It will continue to operate at lower voltages, but will not reach full power. Be sure the electrical service can supply enough amperage for all the components connected to it.

We recommend that a stiff (robust) supply of AC power be used because the amplifiers place high current demands on the AC line. The more power that is available on the line, the louder the speakers will play and the more peak output power will be available for a cleaner, punchier bass. A suspected problem of “poor bass performance” is often caused by a weak AC supply to the amplifiers.



Never remove the ground pin on the power cord or any other component of the Thrash loudspeaker. This is very dangerous.

Care and Maintenance

Your Thrash loudspeakers will provide many years of reliable service if you follow these guidelines:

- Avoid exposing the loudspeakers to moisture. If they are set up outdoors, be sure they are under cover if rain is expected.
- Avoid exposure to extreme cold (below freezing temperatures). If you must operate the loudspeakers in a cold environment, warm up the voice coils slowly by sending a low-level signal through them for about 15 minutes prior to high-power operation.
- Use a dry cloth to clean the cabinets. Only do this when the power is turned off. Avoid getting moisture into any of the openings of the cabinet, particularly where the drivers are located.

Placement



WARNING: Installation should only be done by an experienced technician. Improper installation may result in damage to the equipment, injury or death. Make sure that the loudspeaker is installed in a stable and secure way in order to avoid any conditions that may be dangerous for persons or structures.

Thrash loudspeakers are designed to sit on the floor or stage as the main PA or as monitors. They may also be pole-mounted via the built-in socket on the bottom of the cabinet. Be sure the pole is capable of supporting the weight of the loudspeaker. The T100 is a great tripod option and the SPM200 is a nice choice when using a subwoofer.



NEVER attempt to suspend a Thrash loudspeaker by its handles.

Check to make sure that the support surface (e.g. floor, etc.) has the necessary mechanical characteristics to support the weight of the loudspeaker(s).

When pole-mounting loudspeakers, be sure that they are stabilized and secured from falling over or being accidentally pushed over. Failure to follow these precautions may result in damage to the equipment, personal injury, or death.

Thrash loudspeakers may be laid out horizontally as monitors for the band at a 45° angle (as seen below). It is intended to be used only when the speaker is in its wedge configuration and works best when on a hard work surface, like a stage.

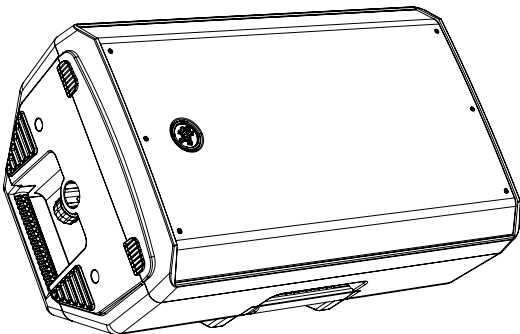

As seen above, the Running Man logo is rotatable for when the loudspeaker is used as a monitor!

As with any powered components, protect them from moisture. Avoid installing the loudspeaker in places exposed to harsh weather conditions. If you are setting them up outdoors, make sure they are under cover if you expect rain.

Room Acoustics

Thrash loudspeakers are designed to sound fantastic in nearly every application.

But, room acoustics play a crucial role in the overall performance of a sound system. However, the wide high-frequency dispersion of the Thrash loudspeakers helps to minimize the problems that typically arise.

Here are some additional placement tips to help overcome some typical room problems that might arise:

- Placing loudspeakers in the corners of a room increases the low frequency output and can cause the sound to be muddy and indistinct.
- Placing loudspeakers against a wall increases the low frequency output, though not as much as corner placement. However, this is a good way to reinforce the low frequencies, if so desired.
- Avoid placing the speakers directly on a hollow stage floor. A hollow stage can resonate at certain frequencies, causing peaks and dips in the frequency response of the room. It is better to place them on a sturdy stand designed to handle the weight of the loudspeaker.
- Position the loudspeakers so the high-frequency drivers are two to four feet above ear level for the audience (making allowances for an audience that may be standing/dancing in the aisles). High frequencies are highly directional and tend to be absorbed much easier than lower frequencies. By providing direct line-of-sight from the loudspeakers to the audience, you increase the overall brightness and intelligibility of the sound system.
- Highly reverberant rooms, like many gymnasiums and auditoriums, are a nightmare for sound system intelligibility. Multiple reflections off the hard walls, ceiling, and floor play havoc with the sound. Depending on the situation, you may be able to take some steps to minimize the reflections, such as putting carpeting on the floors, closing draperies to cover large glass windows, or hanging tapestries or other materials on the walls to absorb some of the sound.

However, in most cases, these remedies are not possible or practical. So what do you do? Making the sound system louder generally doesn't work because the reflections become louder, too. The best approach is to provide as much direct sound coverage to the audience as possible. The farther away you are from the speaker, the more prominent will be the reflected sound.

Use more speakers strategically placed so they are closer to the back of the audience. If the distance between the front and back speakers is more than about 100 feet, you should use an external delay processor to time-align the sound. (Since sound travels about 1 foot per millisecond, it takes about 1/10 of a second to travel 100 feet.)

Appendix A: Service Information

If you think your Thrash loudspeaker has a problem, please check out the following troubleshooting tips and do your best to confirm the problem. Visit the Support section of our website (www.mackie.com/support) where you will find lots of useful information such as FAQs and other documentation. You may find the answer to the problem without having to part with your loudspeaker.

Troubleshooting

No power

- Our favorite question: Is it plugged in? Make sure the AC outlet is live [check with a tester or lamp].
- Our next favorite question: Is the power switch on? If not, try turning it on.
- Make sure the line cord is securely seated in the line cord socket and plugged all the way into the AC outlet.
- Is the power LED on the front panel illuminated? If not, make sure the AC outlet is live. If so, refer to “No sound” below.
- The internal AC line fuse may be blown. This is not a user serviceable part. If you suspect the AC line fuse is blown, please see the “Repair” section next.

No sound

- Is the level knob for the input source turned all the way down? Verify that all the volume controls in the system are properly adjusted. Look at the level meter to ensure that the mixer is receiving a signal.
- Is the signal source working? Make sure the connecting cables are in good repair and securely connected at both ends. Make sure the output level control on the mixing console is turned up sufficiently to drive the inputs of the speaker.
- Make sure the mixer does not have a mute on or a processor loop engaged. If you find something like this, make sure the level is turned down before disengaging the offending switch.
- Has it shut down? Make sure there is at least six inches of free space behind each Thrash loudspeaker.

Poor sound

- Is it loud and distorted? Make sure that you’re not overdriving a stage in the signal chain. Verify that all level controls are set properly.
- Is the input connector plugged completely into the jack? Be sure all connections are secure.

Noise

- Make sure all connections to the loudspeakers are good and sound.
- Make sure none of the signal cables are routed near AC cables, power transformers, or other EMI-inducing devices.
- Is there a light dimmer or other SCR-based device on the same AC circuit as the Thrash loudspeaker? Use an AC line filter or plug the loudspeaker into a different AC circuit.

Hum

- Try disconnecting the cable connected to the input jack. If the noise disappears, it could be a “ground loop,” rather than a problem with the Thrash loudspeaker. Try some of the following troubleshooting ideas:
 - Use balanced connections throughout your system for the best noise rejection.
 - Whenever possible, plug all the audio equipment’s line cords into outlets which share a common ground. The distance between the outlets and the common ground should be as short as possible.

Other Issues

- Please email or call Technical Support if you are having any other issue not listed here:
 - o mackie.com/support-contact
 - o 1-800-898-3211

Repair

For warranty service, refer to the warranty information on page 17.

Non-warranty service is available at a factory-authorized service center. To locate the nearest service center, visit www.mackie.com/support/service-locator. Service for Thrash loudspeakers living outside the United States may be obtained through local dealers or distributors.

If you do not have access to our website, please call our Tech Support department at 1-800-898-3211 (normal business hours, Pacific Time), to explain the problem. They will tell you where the nearest factory-authorized service center is located in your area.

Appendix B: Technical Information

Thrash Loudspeakers Specifications

Acoustic Performance

Frequency Range (-10 dB)	52 Hz – 20 kHz [Thrash212] 38 Hz – 20 kHz [Thrash215]
Frequency Range (-3 dB)	65 Hz – 20 kHz [Thrash212] 55 Hz – 20 kHz [Thrash215]
Horizontal Coverage Angle	90°
Vertical Coverage Angle	60°
Maximum SPL Peak	125 dB [Thrash212] 126 dB [Thrash215]
Monitor Angle	45°

Transducers

Low Frequency	12 in / 305 mm [Thrash212] 15 in / 381 mm [Thrash215] with ferrite
High Frequency	1.0 in / 25 mm titanium high frequency driver

Power Amplifiers

System Power Amplification	
Rated Power	1300 watts peak
Low Frequency Power Amplifier	
Rated Power	1000 watts peak
Rated THD	< 1%
Cooling	Convection
Design	Class D
High Frequency Power Amplifier	
Rated Power	300 watts peak
Rated THD	< 1%
Cooling	Convection
Design	Class D

Input/Output

Input Type	2x Female XLR – 1/4" Balanced TRS combo jack
Mic Impedance	20 kΩ Balanced
Line Impedance	1 MΩ Unbalanced Hi-Z
Mix Out	Male XLR Balanced
Mix Out Impedance	600 Ω Balanced

Electronic Crossover

Crossover Type	24 dB/octave
Crossover Frequency	2.4 kHz

Line Input Power

Detachable line cord	100 – 240 VAC, 50 – 60 Hz, 75W
AC Connector	3-pin IEC 250 VAC, 10 A male
Power Supply Type	Switchmode

Safety Features

Input Protection	Peak and RMS limiting, power supply and amplifier thermal protection
Display LED	Rear panel power / overload

Physical Properties

Thrash212:	
Height:	26.4 in / 669 mm
Width:	14.8 in / 375 mm
Depth:	12.3 in / 313 mm
Weight:	36.4 lb / 16.5 kg
Thrash215:	
Height:	28.0 in / 711 mm
Width:	17.1 in / 434 mm
Depth:	14.3 in / 363 mm
Weight:	40.8 lb / 18.5 kg

Mounting Methods:

Floor mount, pole mount via the built-in socket on the bottom of the cabinet [Be sure the pole is capable of supporting the weight of the loudspeaker].

There are no rigging points and they are NOT suitable for rigging. Do not suspend a Thrash loudspeaker by its handles.

See page 13 for more information.

Options

T100 Loudspeaker Tripod Stand	P/N 2052464
SPM200 Loudspeaker Pole Mount	P/N 2035170

Disclaimer

Since we are always striving to make our products better by incorporating new and improved materials, components, and manufacturing methods, we reserve the right to change these specifications at any time without notice.

The "Running Man" figure is a registered trademark of LOUD Audio, LLC.

All other brand names mentioned are trademarks or registered trademarks of their respective holders, and are hereby acknowledged.

©2021 LOUD Audio, LLC. All Rights Reserved.

Thrash Block Diagram

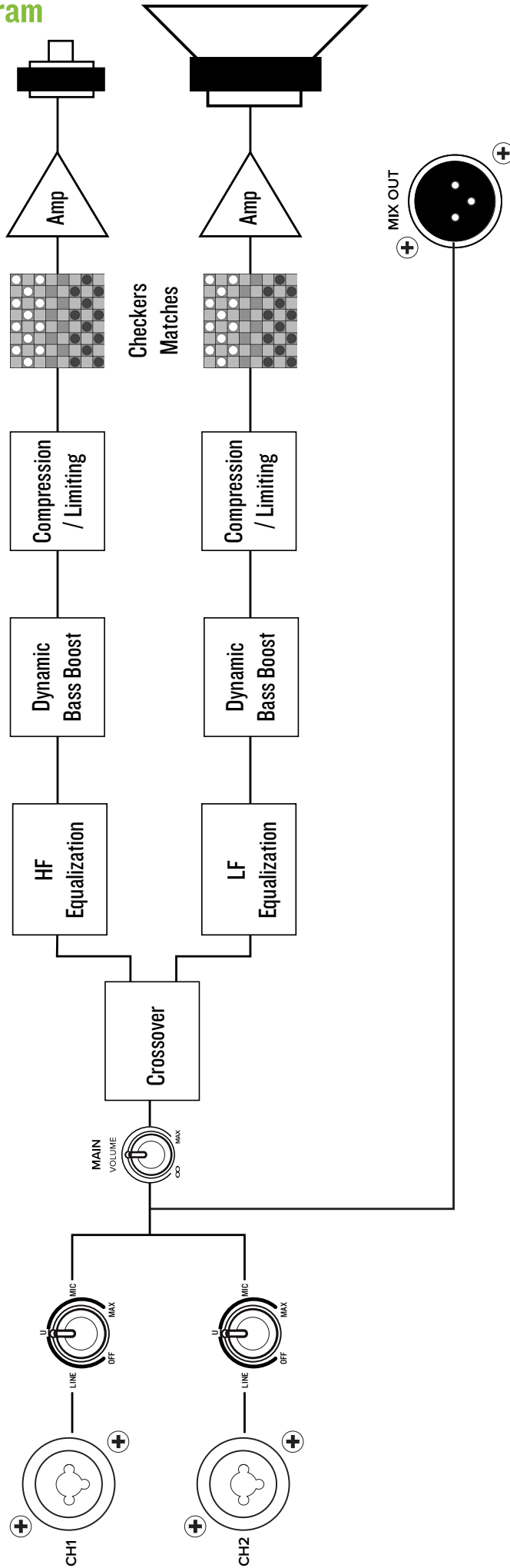

Limited Warranty

Please keep your sales receipt in a safe place.

This Limited Product Warranty ("Product Warranty") is provided by LOUD Audio, LLC ("LOUD") and is applicable to products purchased in the United States or Canada through a LOUD-authorized reseller or dealer. The Product Warranty will not extend to anyone other than the original purchaser of the product (hereinafter, "Customer," "you" or "your").

For products purchased outside the U.S. or Canada, please visit www.mackie.com to find contact information for your local distributor, and information on any warranty coverage provided by the distributor in your local market.

LOUD warrants to Customer that the product will be free from defects in materials and workmanship under normal use during the Warranty Period. If the product fails to conform to the warranty then LOUD or its authorized service representative will at its option, either repair or replace any such nonconforming product, provided that Customer gives notice of the noncompliance within the Warranty Period to the Company at: www.mackie.com or by calling LOUD technical support at 1.800.898.3211 (toll-free in the U.S. and Canada) during normal business hours Pacific Time, excluding weekends or LOUD holidays. Please retain the original dated sales receipt as evidence of the date of purchase. You will need it to obtain any warranty service.

For full terms and conditions, as well as the specific duration of the Warranty for this product, please visit www.mackie.com.

The Product Warranty, together with your invoice or receipt, and the terms and conditions located at www.mackie.com constitutes the entire agreement, and supersedes any and all prior agreements between LOUD and Customer related to the subject matter hereof. No amendment, modification or waiver of any of the provisions of this Product Warranty will be valid unless set forth in a written instrument signed by the party to be bound thereby.

Need help with the Thrash Loudspeakers?

- Visit www.mackie.com/support to find: FAQs, manuals, addendums, and other documents.
- Email us at: www.mackie.com/support-contact
- Telephone 1-800-898-3211 to speak with one of our splendid technical support chaps (Monday through Friday, normal business hours, Pacific Time).



19820 North Creek Parkway #201

Bothell, WA 98011 • USA

Phone: 425.487.4333

Toll-free: 800.898.3211

Fax: 425.487.4337

www.mackie.com
