

UltraLite-mk4™

User Guide

MOTU

1280 Massachusetts Avenue
Cambridge, MA 02138
Business voice: (617) 576-2760
Business fax: (617) 576-3609
Web site: www.motu.com
Tech support: www.motu.com/support

SAFETY PRECAUTIONS AND ELECTRICAL REQUIREMENTS FOR THE UltraLite-mk4 ("PRODUCT")



CAUTION! READ THIS SAFETY GUIDE BEFORE YOU BEGIN INSTALLATION OR OPERATION. FAILURE TO COMPLY WITH SAFETY INSTRUCTIONS COULD RESULT IN BODILY INJURY OR EQUIPMENT DAMAGE.



HAZARDOUS VOLAGES: CONTACT MAY CAUSE ELECTRIC SHOCK OR BURN. TURN OFF UNIT BEFORE SERVICING.

WARNING: TO REDUCE THE RISK OF FIRE OR ELECTRICAL SHOCK, DO NOT EXPOSE THIS APPLIANCE TO RAIN OR OTHER MOISTURE.

CAUTION: TO REDUCE THE RISK OF ELECTRICAL SHOCK, DO NOT REMOVE COVER. NO USER-SERVICEABLE PARTS INSIDE. REFER SERVICING TO QUALIFIED SERVICE PERSONNEL.

IMPORTANT SAFEGUARDS

1. Read these instructions. All the safety and operating instructions should be read before operating the product.
2. Keep these instructions. These safety instructions and the product owner's manual should be retained for future reference.
3. Heed all warnings. All warnings on the product and in the owner's manual should be adhered to.
4. Follow all Instructions. All operating and use instructions should be followed.
5. Do not use the product near water.
6. Cleaning - Unplug the product from the computer and clean only with a dry cloth. Do not use liquid or aerosol cleaners.
7. Ventilation - Do not block any ventilation openings. Install in accordance with the manufacturer's instructions.
8. Heat - Do not install the product near any heat sources such as radiators, heat registers, stoves, or another apparatus (including an amplifier) that produces heat.
9. Overloading - Do not overload wall outlets and extension cords as this can result in a risk of fire or electrical shock.
10. Power supply cord - Protect the product power supply cord from being walked on or pinched by items placed upon or against them.
11. Power switch - Install the product so that the power switch can be accessed and operated at all times.
12. Disconnect - The main power supply plug is considered to be the disconnect device for the product and shall remain readily operable.
13. Accessories - Only use attachments/accessories specified by the manufacturer.
14. Surge protection - Unplug the product during lightning storms or when unused for long periods of time.
15. Servicing - Refer all servicing to qualified service personnel. Servicing is required when the product has been damaged in any way, such as when a power-supply cord or plug is damaged, liquid has been spilled or objects have fallen into the product, the product has been exposed to rain or moisture, does not operate normally, or has been dropped.
16. Power Sources - Refer to the manufacturer's operating instructions for power requirements.
17. Installation - Do not install the product in an unventilated rack, or directly above heat-producing equipment such as power amplifiers. Observe the maximum ambient operating temperature listed below.
18. Power amplifiers - Never attach audio power amplifier outputs directly to any of the unit's connectors.
19. Replacement Parts - When replacement parts are required, be sure the service technician has used replacement parts specified by the manufacturer or have the same characteristics as the original part. Unauthorized substitutions may result in fire, electric shock or other hazards.
20. Safety Check - Upon completion of any service or repairs to this MOTU product, ask the service technician to perform safety checks to determine that the product is in safe operating conditions.

ENVIRONMENT, HEAT AND VENTILATION

Operating Temperature: 10°C to 40°C (50°F to 104°F). The product should be situated away from heat sources or other equipment that produces heat. When installing the product in a rack or any other location, be sure there is adequate space around the product to ensure proper ventilation. Improper ventilation will cause overheating and can damage the unit.

TO REDUCE THE RISK OF ELECTRICAL SHOCK OR FIRE

Do not handle the power supply with wet hands. Do not pull on the power supply cord when disconnecting it from an AC wall outlet. Grasp it by the plug. Do not expose this apparatus to rain or moisture. Do not place objects containing liquids on it.

DC INPUT

10 - 24V DC • 1.0A max



Contents

Part 1: Getting Started

- 7 **Quick Start Guide**
- 9 **UltraLite-mk4 Front Panel**
- 10 **UltraLite-mk4 Rear Panel**
- 11 **MOTU Pro Audio Control Web App**
- 23 **About the UltraLite-mk4**
- 25 **Packing List and System Requirements**
- 27 **Software Installation**
- 31 **Hardware Installation**

Part 2: Using the UltraLite-mk4

- 39 **Presets**
- 43 **The Front Panel LCD**
- 45 **Working with Host Audio Software**
- 53 **Mixer Effects**
- 61 **MOTU Audio Tools**

Part 3: Appendices

- 79 **Troubleshooting**
- 81 **Audio Specifications**
- 83 **Mixer Schematics**
- 87 **Updating Firmware**
- 89 **Auto-on Mode**
- 91 **Index**

About the Mark of the Unicorn License Agreement and Limited Warranty on Software

TO PERSONS WHO PURCHASE OR USE THIS PRODUCT: carefully read all the terms and conditions of the "click-wrap" license agreement presented to you when you install the software. Using the software or this documentation indicates your acceptance of the terms and conditions of that license agreement.

Mark of the Unicorn, Inc. ("MOTU") owns both this program and its documentation. Both the program and the documentation are protected under applicable copyright, trademark, and trade-secret laws. Your right to use the program and the documentation are limited to the terms and conditions described in the license agreement.

Reminder of the terms of your license

This summary is not your license agreement, just a reminder of its terms. The actual license can be read and printed by running the installation program for the software. That license agreement is a contract, and clicking "Accept" binds you and MOTU to all its terms and conditions. In the event anything contained in this summary is incomplete or in conflict with the actual click-wrap license agreement, the terms of the click-wrap agreement prevail.

YOU MAY: (a) use the enclosed program on a single computer; (b) physically transfer the program from one computer to another provided that the program is used on only one computer at a time and that you remove any copies of the program from the computer from which the program is being transferred; (c) make copies of the program solely for backup purposes. You must reproduce and include the copyright notice on a label on any backup copy.

YOU MAY NOT: (a) distribute copies of the program or the documentation to others; (b) rent, lease or grant sublicenses or other rights to the program; (c) provide use of the program in a computer service business, network, time-sharing, multiple CPU or multiple user arrangement without the prior written consent of MOTU; (d) translate, adapt, reverse engineer, decompile, disassemble, or otherwise alter the program or related documentation without the prior written consent of MOTU.

MOTU warrants to the original licensee that the disk(s) on which the program is recorded be free from defects in materials and workmanship under normal use for a period of ninety (90) days from the date of purchase as evidenced by a copy of your receipt. If failure of the disk has resulted from accident, abuse or misapplication of the product, then MOTU shall have no responsibility to replace the disk(s) under this Limited Warranty.

THIS LIMITED WARRANTY AND RIGHT OF REPLACEMENT IS IN LIEU OF, AND YOU HEREBY WAIVE, ANY AND ALL OTHER WARRANTIES, BOTH EXPRESS AND IMPLIED, INCLUDING BUT NOT LIMITED TO WARRANTIES OF MERCHANTABILITY AND FITNESS FOR A PARTICULAR PURPOSE. THE LIABILITY OF MOTU PURSUANT TO THIS LIMITED WARRANTY SHALL BE LIMITED TO THE REPLACEMENT OF THE DEFECTIVE DISK(S), AND IN NO EVENT SHALL MOTU OR ITS SUPPLIERS, LICENSORS, OR AFFILIATES BE LIABLE FOR INCIDENTAL OR CONSEQUENTIAL DAMAGES, INCLUDING BUT NOT LIMITED TO LOSS OF USE, LOSS OF PROFITS, LOSS OF DATA OR DATA BEING RENDERED INACCURATE, OR LOSSES SUSTAINED BY THIRD PARTIES EVEN IF MOTU HAS BEEN ADVISED OF THE POSSIBILITY OF SUCH DAMAGES. THIS WARRANTY GIVES YOU SPECIFIC LEGAL RIGHTS WHICH MAY VARY FROM STATE TO STATE. SOME STATES DO NOT ALLOW THE LIMITATION OR EXCLUSION OF LIABILITY FOR CONSEQUENTIAL DAMAGES, SO THE ABOVE LIMITATION MAY NOT APPLY TO YOU.

Update Policy

In order to be eligible to obtain updates of the program, you must complete and return the attached Mark of the Unicorn Purchaser Registration Card to MOTU.

Copyright Notice

Copyright © 2016 by Mark of the Unicorn, Inc. All rights reserved. No part of this publication may be reproduced, transmitted, transcribed, stored in a retrieval system, or translated into any human or computer language, in any form or by any means whatsoever, without express written permission of Mark of the Unicorn, Inc., 1280 Massachusetts Avenue, Cambridge, MA, 02138, U.S.A.

Limited Warranty on Hardware

Mark of the Unicorn, Inc. and S&S Research ("MOTU/S&S") warrant this equipment against defects in materials and workmanship for a period of TWO (2) YEARS from the date of original retail purchase. This warranty applies only to hardware products; MOTU software is licensed and warranted pursuant to separate written statements.

If you discover a defect, first write or call Mark of the Unicorn at (617) 576-2760 to obtain a Return Merchandise Authorization Number. No service will be performed on any product returned without prior authorization. MOTU will, at its option, repair or replace the product at no charge to you, provided you return it during the warranty period, with transportation charges prepaid, to Mark of the Unicorn, Inc., 1280 Massachusetts Avenue, MA 02138. You must use the product's original packing material for in shipment, and insure the shipment for the value of the product. Please include your name, address, telephone number, a description of the problem, and the original, dated bill of sale with the returned unit and print the Return Merchandise Authorization Number on the outside of the box below the shipping address.

This warranty does not apply if the equipment has been damaged by accident, abuse, misuse, or misapplication; has been modified without the written permission of MOTU, or if the product serial number has been removed or defaced.

ALL IMPLIED WARRANTIES, INCLUDING IMPLIED WARRANTIES OF MERCHANTABILITY AND FITNESS FOR A PARTICULAR PURPOSE, ARE LIMITED IN DURATION TO TWO (2) YEARS FROM THE DATE OF THE ORIGINAL RETAIL PURCHASE OF THIS PRODUCT.

THE WARRANTY AND REMEDIES SET FORTH ABOVE ARE EXCLUSIVE AND IN LIEU OF ALL OTHERS, ORAL OR WRITTEN, EXPRESS OR IMPLIED. No MOTU/S&S dealer, agent, or employee is authorized to make any modification, extension, or addition to this warranty.

MOTU/S&S ARE NOT RESPONSIBLE FOR SPECIAL, INCIDENTAL, OR CONSEQUENTIAL DAMAGES RESULTING FROM ANY BREACH OF WARRANTY, OR UNDER ANY LEGAL THEORY, INCLUDING LOST PROFITS, DOWNTIME, GOODWILL, DAMAGE OR REPLACEMENT OF EQUIPMENT AND PROPERTY AND COST OF RECOVERING REPROGRAMMING, OR REPRODUCING ANY PROGRAM OR DATA STORED IN OR USED WITH MOTU/S&S PRODUCTS.

Some states do not allow the exclusion or limitation of implied warranties or liability for incidental or consequential damages, so the above limitation or exclusion may not apply to you. This warranty gives you specific legal rights, and you may have other rights which vary from state to state.

MOTU, Digital Performer, AudioDesk, Mark of the Unicorn and the unicorn silhouette logo are trademarks of Mark of the Unicorn, Inc.

Thunderbolt and the Thunderbolt logo are trademarks of Intel Corporation in the U.S. and/or other countries.

This equipment has been type tested and found to comply with the limits for a class B digital device, pursuant to Part 15 of the FCC Rules. These limits are designed to provide reasonable protection against harmful interference in a residential installation. This equipment generates, uses, and can radiate radio frequency energy and, if not installed and used in accordance with the instruction manual, may cause harmful interference to radio communications. However, there is no guarantee that interference will not occur in a particular installation. If this equipment does cause interference to radio or television equipment reception, which can be determined by turning the equipment off and on, the user is encouraged to try to correct the interference by any combination of the following measures:

- Relocate or reorient the receiving antenna
- Increase the separation between the equipment and the receiver
- Plug the equipment into an outlet on a circuit different from that to which the receiver is connected

If necessary, you can consult a dealer or experienced radio/television technician for additional assistance.

PLEASE NOTE: only equipment certified to comply with Class B (computer input/output devices, terminals, printers, etc.) should be attached to this equipment, and it must have shielded interface cables in order to comply with the Class B FCC limits on RF emissions.

WARNING: changes or modifications to this unit not expressly approved by the party responsible for compliance could void the user's authority to operate the equipment.



Part 1

Getting Started

Quick Start Guide

Thank you for purchasing an UltraLite-mk4! Follow these easy steps to get started quickly.

1 Download and run the *MOTU Pro Audio Installer* found here:

<http://www.motu.com/download>

2 (Optional) For quick access to the UltraLite-mk4 from your iPad or iPhone, download the MOTU Discovery app from the Apple App Store.

👉 Your iPhone and iPad must be on the same Wi-Fi network as your computer.

3 Connect the interface to your computer with a USB cable (included).

4 Switch on the UltraLite-mk4.

5 Open the *MOTU Pro Audio Control* web app by doing one of the following:

- Choose the UltraLite-mk4 from the MOTU Discovery app menu (found in the Mac menu bar or Windows taskbar).

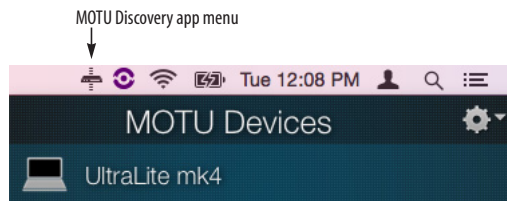

- Alternately, you can launch the *MOTU Pro Audio WebUI Setup* shortcut found on the Windows desktop or in *Start menu > All Programs > MOTU*.

- From your iPad or iPhone, launch the MOTU Discovery app, and tap your interface.

- You should now see the *MOTU Pro Audio Control* web app in your browser, as shown on page 12. If not, visit Appendix A, “Troubleshooting” (page 79).

6 Click *Quick Setup* and choose a preset.

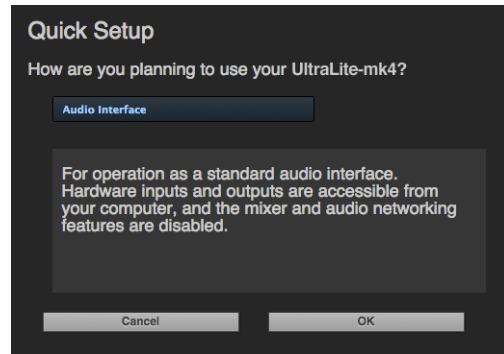

Preset	Application
Audio interface	Operate as a standard audio interface.
Stand-alone mixer	Operate as a stand-alone mixer, where all inputs are mixed to the main outs and monitor outs.
Interface + mixer	A combination of the above two presets.
Live recording with monitor mixing	Record a live concert or recording session, with a full monitor mix.
Optical Converter	Multi-channel analog-to-digital and digital-to-analog converter.

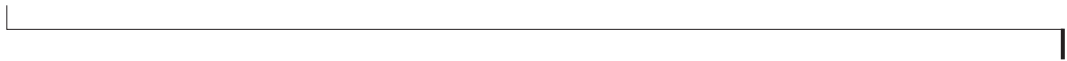

UltraLite-mk4 Front Panel



1. MIC/GUITAR INPUTS. These XLR/TRS combo jacks accept either a mic cable or a quarter-inch cable, balanced or unbalanced, from a guitar or line input. Use the controls to the right (3) to adjust individual preamp gain, instrument input trim, 48V phantom power, and an optional -20 dB pad for each mic input.
2. HEADPHONE OUTPUT with volume control.
3. Individual PREAMP GAIN, INSTRUMENT INPUT TRIM, switchable 48V phantom power, and optional -20 dB pad switches for each combo input. The Precision Digital Trim™ knob provides +60 dB of preamp gain or +30 dB of instrument input gain. Both gain settings are retained independently. Turn the knob to see the gain adjustments in the LCD.
4. This portion of the LCD displays level meters for all analog inputs and outputs. It can also show device settings, using the knobs to the left.
5. This portion of the multi-purpose backlit LCD shows digital I/O activity (optical and S/PDIF) and MIDI activity (in and out).
6. This portion of the LCD displays the current sample rate and clock source, such as *Int* (Internal clock mode).
7. Push SELECT to enter the LCD menu. Turn SELECT to scroll through menu options. Push again to descend into the submenus, if applicable. To choose the current setting, push SELECT a third time. Push BACK to return to the previous menu level, and do so repeatedly to exit the menu altogether.
8. POWER and VOLUME control for phones and main outs. Push this knob to toggle between PHONE volume and MAIN OUT volume. The LCD provides visual feedback. This setting, along with all front panel settings, can also be adjusted from the MOTU Pro Audio Control web app. Push to power on the unit; push and hold for three seconds to power it off.

UltraLite-mk4 Rear Panel



1. The UltraLite-mk4 operates as a USB MIDI interface, allowing MIDI software to communicate with connected MIDI devices through the USB connection to the computer. Connect a MIDI device here using standard MIDI cables. Connect the UltraLite-mk4's MIDI OUT port to the MIDI IN port on the other device. Conversely, connect the UltraLite-mk4's MIDI IN port to the MIDI OUT port on the other device. For further details, see "MIDI connections" on page 35.
2. The ANALOG OUTPUTS provide additional analog output for secondary studio monitors, surround monitoring, sub-mixes or any other desired destination. These connectors are balanced (tip/ring/sleeve), but they also accept an unbalanced plug. They are DC-coupled. Control volume from the MOTU Pro Audio Control web app or your host audio software.
3. The MAIN OUT pair provides stereo analog output for primary (powered) studio monitors or PA speakers, or any other desired destination. Control volume from the MOTU Pro Audio Control web app or from the front panel volume control.

To hear audio playback from your host audio software on the MAIN OUT pair, use the Audio Interface preset and then assign audio tracks (and master fader) to these main outs. You can also use the MOTU Pro Audio Control web app to route live UltraLite-mk4 inputs here as well.
4. Equipped with very high quality 24-bit 192 kHz converters, these six analog inputs are balanced TRS (tip/ring/sleeve) quarter-inch connectors that can also accept an unbalanced plug (with the ring disconnected). Use them for keyboards or other line level analog sources. These inputs are equipped with the UltraLite-mk4's Precision Digital Trim™ feature: digitally controlled analog trims that let you adjust input level in 1 dB increments from the MOTU Pro Audio Control web app.
5. These jacks provide stereo, 24-bit S/PDIF digital input and output at all supported sample rates (up to 96 kHz). When connecting a source to the input, be sure to set the clock source correctly. See "S/PDIF" on page 34.
6. These ADAT optical "lightpipe" jacks provide 8 channels of 24-bit ADAT optical digital I/O at 1x sample rates (44.1 or 48 kHz) and 4 channels at 2x sample rates (88.2 or 96 kHz). They are disabled at higher sample rates. Alternately, they can operate as stereo TosLink (optical S/PDIF) connectors. Visit the Device tab in the web app (page 14) to configure the optical jacks.
7. Connect the UltraLite-mk4 to the computer here using a standard USB cable.
8. This jack accepts any standard 12-18V DC power supply (1.0A max) with either tip-positive or tip-negative polarity.

MOTU Pro Audio Control Web App

OVERVIEW

MOTU Pro Audio Control is a web app that gives you complete control over the UltraLite-mk4.

IT'S NOT ON YOUR HARD DRIVE

The MOTU Pro Audio Control web app is served from the UltraLite-mk4 hardware itself, therefore it is not an application on your computer's hard drive. Instead, access it from the *MOTU Discovery* app (in the Mac menu bar or Windows taskbar), the *MOTU Pro Audio WebUI Setup* shortcut (Windows only) or through your web browser.

USE YOUR FAVORITE WEB BROWSER

The MOTU Pro Audio Control web app runs in any modern web browser running on the computer connected to the UltraLite-mk4, or any mobile device (tablet or smartphone) on the same Wi-Fi network as the computer. If it can run a web browser, it can run the web app. You can use any browser you prefer: Chrome, Firefox, Safari, etc. The latest versions are strongly recommended.

CONTROL FROM MULTIPLE DEVICES

You can run the web app on multiple host devices simultaneously.

RUN THE INSTALLER, GET THE APP

Visit www.motu.com/download to get the latest MOTU Pro Audio Installer and run it on your computer to install the *MOTU Discovery* app, *MOTU Pro Audio WebUI Setup* shortcut (Windows only) and other software elements. Visit the Apple App Store to download the discovery app onto your iPad or iPhone.

MAKE HARDWARE AND NETWORK CONNECTIONS

Connect your UltraLite-mk4 to your computer or laptop with a USB cable. Make sure your iPad, iPhone, tablet or smartphone is connected to the same Wi-Fi network as your computer or device.

LAUNCHING THE WEB APP

To launch the web app, do any of the following:

- Choose the UltraLite-mk4 from the MOTU Discovery app menu (in the Mac menu bar or Windows taskbar) or launch the *MOTU Pro Audio WebUI Setup* shortcut (Windows only).

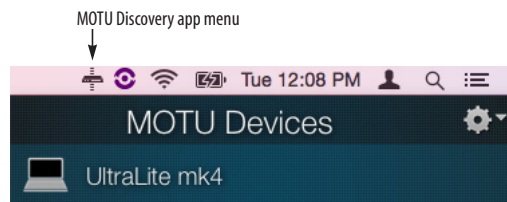

- From your iPad or iPhone, launch the MOTU Discovery app.
- In your favorite web browser, type this URL: `localhost:1280`.

You should now see the MOTU Pro Audio Control web app in your browser, as shown on page 12. If not visit Appendix A, “Troubleshooting” (page 79).

DEVICE TAB

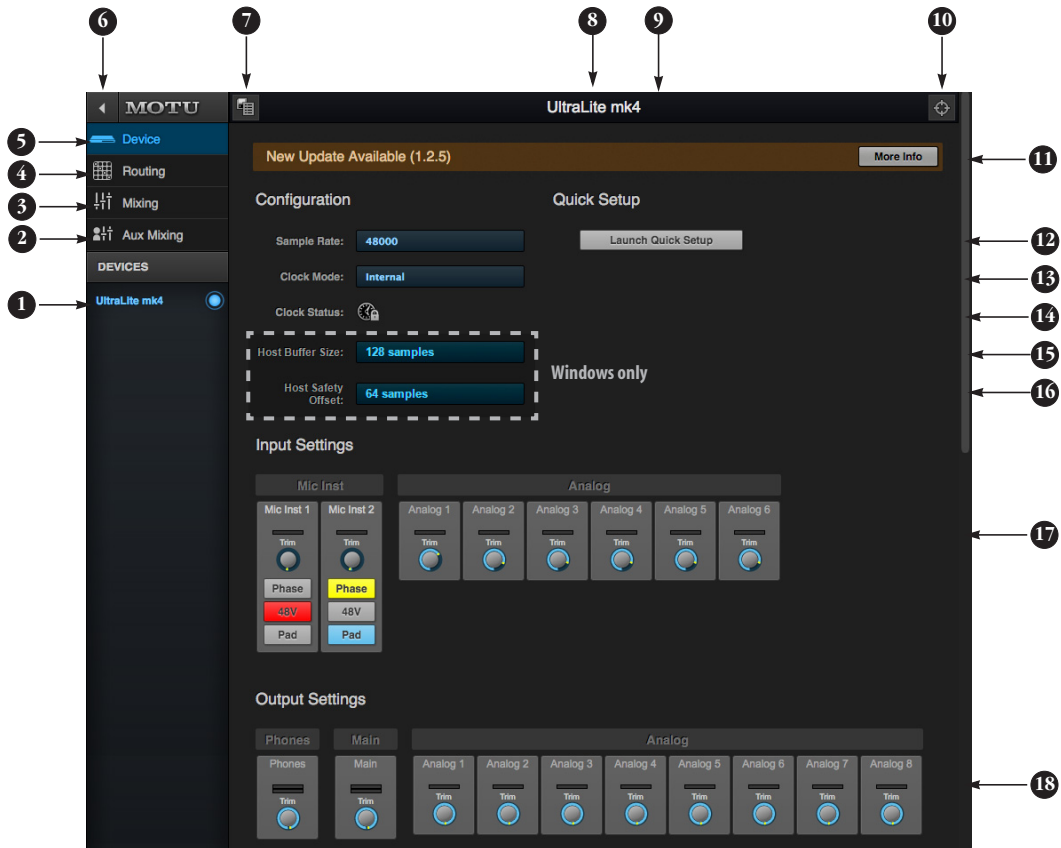

1. If you have two or more MOTU interfaces, the Devices list lets you choose the one you are currently controlling with the web app.
2. The Aux Mixing tab lets you view each Aux bus in the mixer, one at a time.
3. The Mixing tab gives you access to the mixing and DSP in the interface.
4. The Routing tab displays a grid matrix, where you can make direct connections between inputs and outputs, your computer and the mixer.
5. The Device tab has settings for the hardware itself, such as analog input and output trim.
6. Expands and collapses the sidebar.
7. Lets you create, save, recall and manage presets for the UltraLite-mk4. These presets capture and recall the complete state of the device (all settings in all tabs).
8. Click to rename the interface. To restore the default name, delete the current name.
9. The Quick Setup button prompts factory presets used to configure your interface for a specific application. See chapter 5, "Presets" (page 39).
10. Click this device ID button to identify the unit you are currently viewing and controlling with the web app software. The front panel LCD on the hardware itself will flash the name of the device, and its name will also flash in the Device list (1).
11. If an update is available for your device, and the computer you are viewing it from is connected to the internet, you'll be notified here. Click More Info to learn what's new and start the update process. See Appendix D, "Updating Firmware" (page 87).
12. Choose the desired sample rate. Make sure your host audio software is set to the same rate.
13. Choose the clock source from the Clock Mode menu. Your MOTU device will resolve its digital clock to this master source.
14. The Clock Status icon indicates that the current device (1) is successfully resolved to its chosen Clock Mode source (13). If it cannot lock for some reason, this icon flashes red. Check your chosen clock source, cables, etc.
15. (Windows only) Choose the Host Buffer Size. Smaller values reduce latency but increase your computer's CPU load. See "Host Buffer Size" on page 28.
16. (Windows only) Choose a Host Safety Offset to fine tune host buffer latency. See "Host Safety Offset" on page 28.
17. The Input Settings section provides gain settings for inputs, plus phase invert for mic and guitar inputs, if any. You can also toggle the 48V phantom power and -20 dB pad for the mic inputs.
18. The Output Settings section lets you adjust the trim for any output or output pair which supports it. Phones and Main outputs provide full volume control. Analog outputs provide calibration control (-24 to 0 dB).

DEVICE TAB (CONTINUED)

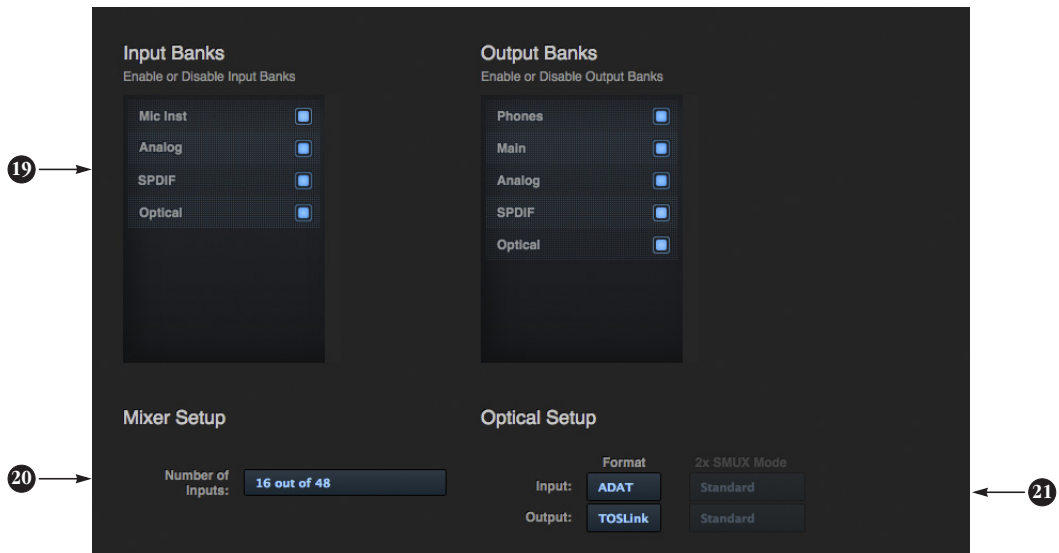

Scroll down to view these additional Device tab settings.

19. In the Input/Output Banks sections, you can disable any banks that you are not using. Doing so hides them from the routing matrix and mixer to simplify operation. Doing so also helps conserve DSP resources.

20. The digital mixer in the UltraLite-mk4 supports up to 48 channels. If you don't need that many inputs, you can lower the number here to simplify mixer and routing operation and conserve DSP bandwidth for effects processing.

21. Configure the optical ports for either 8-channel ADAT or stereo TOSLink. At 88.2 or 96 kHz, the ADAT setting supports 4-channel SMUX format. See "Optical I/O" on page 34.

DEVICE TAB (CONTINUED)

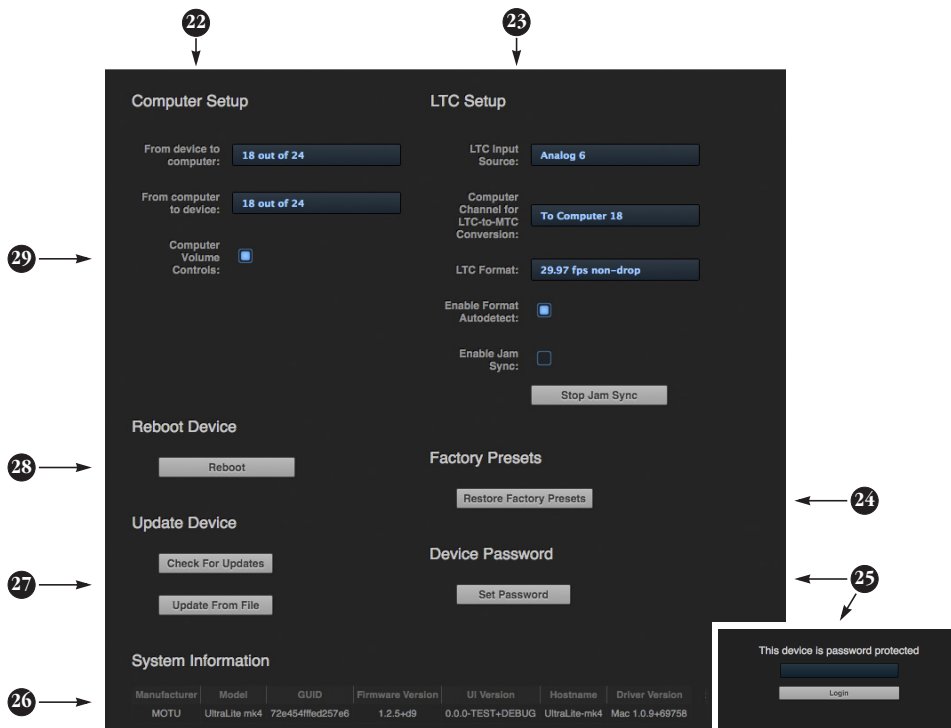

Scroll down to view these additional Device tab settings.

- In the Computer Setup section, you can specify how many audio channels you would like to be able to stream to and from your computer, up to 24 channels each way, simultaneously. Map them as desired in the Routing tab (page 15).
- Your MOTU interface can resolve to SMPTE time code, also referred to as LTC (*Longitudinal Time Code*), by choosing LTC from the Clock Mode menu (item 13 on page 12). From the LTC Input Source menu (23 above), choose the analog or digital input that is receiving the time code. If you would also like to send time code (LTC) to the computer, where it will be converted to MIDI Time Code (MTC) for resolving your DAW or other software to MTC via OS X Core Audio (a Mac-only feature), choose an audio channel you are not using

for other purposes from the *Computer Channel for LTC-to-MTC Conversion* menu; otherwise, leave it set to *None*. Choose the desired frame format, or use the *Enable Format Autodetect* to automatically detect the frame format of the incoming time code. When *Enable Jam Sync* is turned on, your interface will continue to operate under its own clock and continue LTC-to-MTC conversion, even after it stops receiving time code. Click *Stop Jam Sync* to exit this mode. For further details about time code sync, see “Syncing to SMPTE time code (LTC)” on page 35 and “LTC-to-MTC conversion” on page 51.

- Use *Restore Factory Presets* to restore your MOTU device’s factory presets.
- Use *Set Password* to password-protect the interface. All settings are blocked, except for aux bus mixing, as shown above (25). This allows musicians to access their personal

monitor (aux) mixes from their mobile devices, while all other device settings remain blocked. To clear the password, log in and then click *Clear Password*. If you forget the password, you can clear it in the Settings menu in the front panel LCD (see page 44) with either the *Clear Password* setting or by doing a factory reset with the *Factory Default* setting.

- The *System Information* section displays information about your MOTU device, including the firmware version.
- Use these buttons to manually check for and install updates for the UltraLite-mk4. For complete details, see Appendix D, “Updating Firmware” (page 87). Updating from a file can be done offline from your computer, using an update you’ve obtained through MOTU’s web site or tech support department. The *Check For Updates* button requires

that the computer (or device) you are using to view the UltraLite-mk4 is connected to the internet through a local network or Wi-Fi. Updating from the internet is easy and convenient.

- Click *Reboot* to restart the interface.
- When the *Computer Volume Controls* option is enabled (a Mac only feature), the Audio MIDI Setup utility in OS X provides volume control for each output channel to your MOTU audio interface. In addition, the volume controls for your Mac (on your computer keyboard) will control the channels you’ve designated for computer output in Audio MIDI Setup, if any. Be careful when toggling this setting because sudden changes in your computer volume can result.

ROUTING TAB

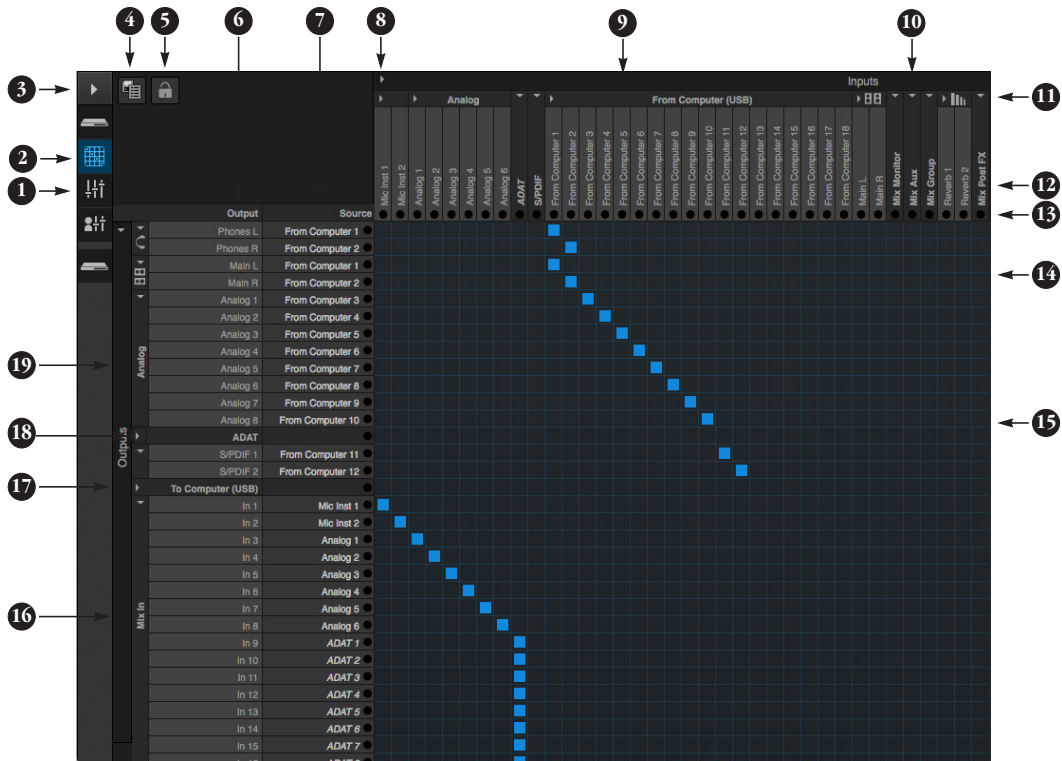

The Routing Tab lets you route inputs to outputs. Outputs are listed by row on the left; inputs are listed in columns across the top. Simply click in the grid to make a single connection. Click and drag to make multiple connections in one gesture. To route a single input to multiple outputs, make multiple connections vertically in the same column below the input. To mix multiple inputs to the same output, you'll need to use the mixer (page 16) and the *Mix In* bank in the routing tab (16).

1. In its collapsed form, (shown here), the sidebar displays icons for each tab.
2. Click this icon to view the Routing tab, shown on this page.
3. Click here to show or hide the sidebar.
4. Create, save, recall and manage routing presets.
5. Locks the grid to prevent accidental changes. Unlock to make changes to the grid.

6. Outputs are listed in rows on the left.
7. When you make a connection, the source (input) signal is listed by name here in the Source column, just to the right of the output it is being routed to.
8. Inputs are listed in columns across the top of the grid, starting with the physical inputs on the hardware itself. In this example, the two mic inputs and six analog (line) inputs are being routed to the computer (over USB).
9. The *From Computer* input bank lets you route audio channels from your host audio software to any output, including the mixer, where you can mix computer audio with local inputs. Use the Device tab to choose how many computer channels are available. In this example, computer channels 1-2 are being routed to both the headphone output and the Main Outs (L-R).

10. These input streams are busses that originate from the mixer, which supplies the main mix bus, monitor mix bus, seven stereo aux busses, three stereo group busses, a reverb return bus and postFX channel sends (for sending processed inputs to the computer or elsewhere). You can route these mixer busses to any outputs you wish (6), including physical outputs, host software on your computer, or even back in to the mixer (beware of feedback loops!)
11. Use these triangles to expand or collapse groups of inputs. For example, it might be convenient to collapse banks that you are not using at the moment.
12. Click a channel label to rename it.
13. Audio activity indicators.
14. Here, Computer channels 1-2 are being routed to the Main Outs on the UltraLite-mk4.

15. Click the grid to make a connection. Click a connection to remove it. Click and drag to make or break multiple connections in one gesture. Note: both the input and output must be expanded or collapsed (11) when clicking to make a connection.
16. The *Mix In* group lets you route audio to the 48-channel mixer.
17. The *To Computer* output bank (currently collapsed in this example) routes any input to host audio software running on your computer. Use the Device tab to choose how many computer channels are available.
18. Use these triangles to expand or collapse groups of outputs.
19. These represent the physical analog outputs on the interface itself.

MIXING TAB

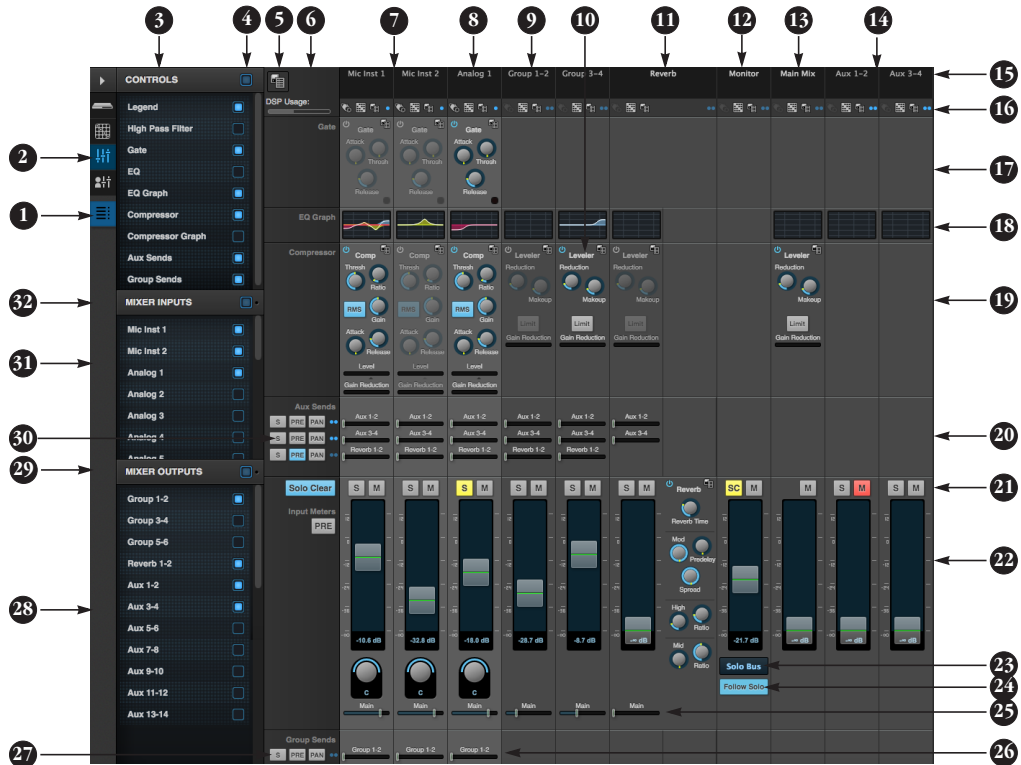

The Mixing tab gives you access to the 48-channel mixer in the UltraLite-mk4, which provides a main mix bus, monitor bus, three group busses, seven aux busses, and a dedicated reverb bus. Use the Device tab to configure how many inputs you wish to work with (up to 48). Use the Routing tab (page 15) to route channels to the mixer inputs. Channels can come from any source, such as the physical inputs on the interface or channels coming from the computer.

1. Shows and hides the Mixer Setup sidebar (3), which lets you show and hide channels, channel strip settings, effects, and the Legend (6).
2. The Mixing tab selects the mixer.
3. Use the Mixer Setup sidebar to show and hide elements in the mixer.
4. Shows and hides all elements in the section with one click.
5. Create, save, recall and manage mixer presets.
6. This column is the Legend. It provides labels and controls for channel strip sections. The menu at

the top lets you create, name, save and manage entire mixer presets.

7. Mixer input channels.
8. This input channel has its Gate and Compressor enabled. Disabled effects are grayed out.
9. This is Group bus 1-2. You can send inputs to this group with their Group send on inputs or groups to route them to the reverb bus, which can then be mixed in with the main mix or aux busses. Disable the reverb processor to use it as an extra group.
10. Group busses, the main mix bus, and the reverb return bus are equipped with the Leveler, a vintage compressor modeled after the Teletronix LA-2A leveling amplifier.
11. The reverb channel strip provides the reverb processor. Use the reverb send on inputs or groups to route them to the reverb bus, which can then be mixed in with the main mix or aux busses. Disable the reverb processor to use it as an extra group.
12. The Monitor Bus can mirror the output of any other bus, or it can act as a separate Solo bus. See page 19.

13. The Main Mix bus is the master fader for the entire mixer. You can add EQ and Leveler compression.

14. You can adjust Aux bus output levels here, or in the Aux Mixing tab shown on page 17.
15. Click a name to change it, except for the Main Mix, Monitor, and Reverb busses, which cannot be changed.
16. Stereo toggle to switch channels pairs between mono or stereo. Use the other menus to manage channel strip presets and to choose audio sources and destinations for mixer inputs and bus outputs.
17. Gate processing for inputs.
18. Click the thumbnail EQ graph to open the full-size, editable EQ graph (Figure 8-4 on page 55).
19. The Dynamics section provides a conventional compressor for inputs and the Leveler for output busses.
20. Reverb and aux sends.

21. Solo and mute. On the Monitor bus, the SC button clears all solos.

22. Channel faders.
23. Choose the source for the Monitor bus from this menu. It can mirror any output bus or the Solo Bus.
24. When *Follow Solo* is enabled, the Monitor bus temporarily switches to the solo bus when any channel is soloed.
25. Main Mix sends.
26. Group sends.
27. 'S' lets you solo the group. 'PRE' toggles the sends between pre- and post-fader routing, i.e. before or after the channel fader.
28. Show and hide output busses here.
29. Show/hide all busses with one click.
30. Same as (27) above.
31. Show and hide inputs here.
32. Show/hide all inputs with one click.

AUX MIXING TAB

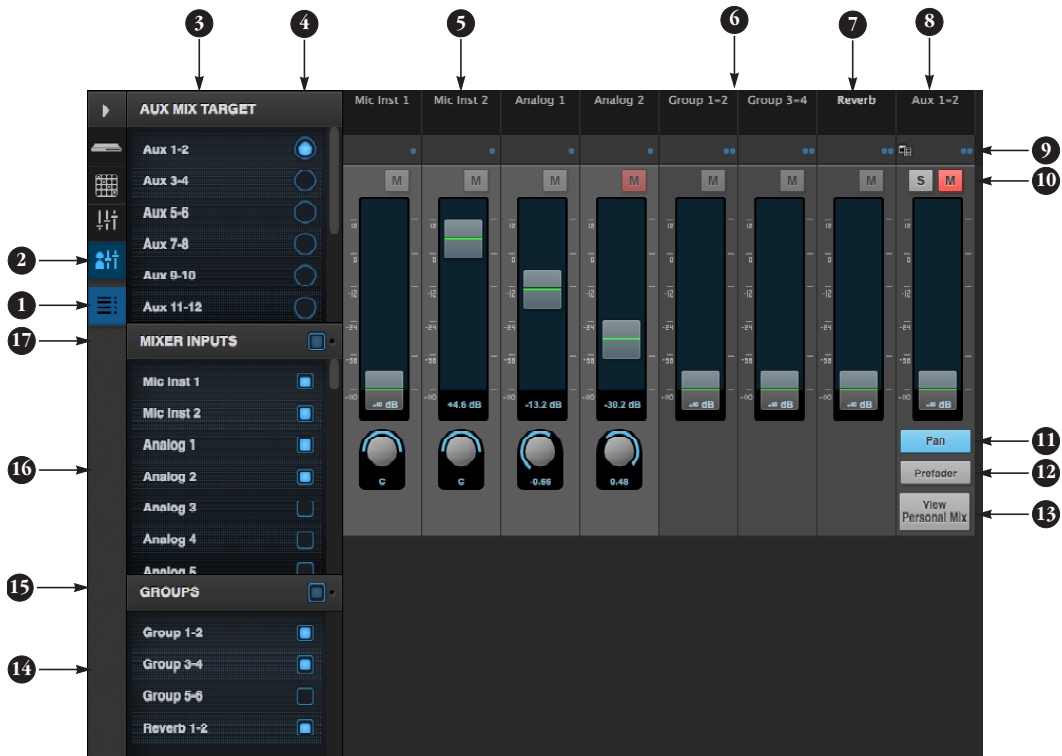

The Aux Mixing tab provides quick access to the UltraLite-mk4's mix busses (aux busses, groups and reverb bus), viewed one at a time. Choose a bus in the Aux Mix Target section and then use the faders to directly mix the send levels from all mixer inputs, groups, and the reverb bus.

- Shows and hides the Mixer Setup sidebar (3), which lets you show and hide channels.
- The Aux Mixing tab (shown on this page) gives you access to the Aux busses and groups in the mixer.
- Use the *Aux Mix Target* sidebar to control which aux bus or group you are currently viewing. You can also show/hide inputs and group sends.
- Click the aux bus or group you wish to view in the window. In this example, Aux bus 1-2 is being displayed.
- These are mixer inputs (aux sends from each mixer channel). To include an input in the aux bus mix, simply bring up its fader.
- These are group bus faders.
- This is the mixer's reverb bus fader.
- This is the master fader for the current aux bus being viewed (4).
- Indicates if the input or group is stereo or mono. This indicator is for display purposes only. To toggle between mono and stereo operation, use the toggle switch in the Mixing tab (item #16 on page 16).
- Solo and mute for the aux bus master fader.
- Shows and hides the pan controls for aux bus inputs.
- When *Prefader* is enabled, all send levels to the aux bus are independent of the main fader for each channel. In other words, changing an individual channel's main fader in the Mixing tab won't affect its send level to the aux bus.
- Click the *View Personal Mix* button to open a new web page that displays only that specific Aux Mix or Group. This is perfect for musicians who want to control their own monitor mix.
- Show and hide mix groups and the reverb bus here.
- Use the Groups button here to show or hide all groups with one click. Drag this section divider to show more or less of the group list.
- Show and hide mixer inputs (channel sends) here.
- Show and hide all mixer inputs with one click here. Drag this section divider to show more or less of the mixer input list.

MIXER INPUT CHANNEL STRIPS

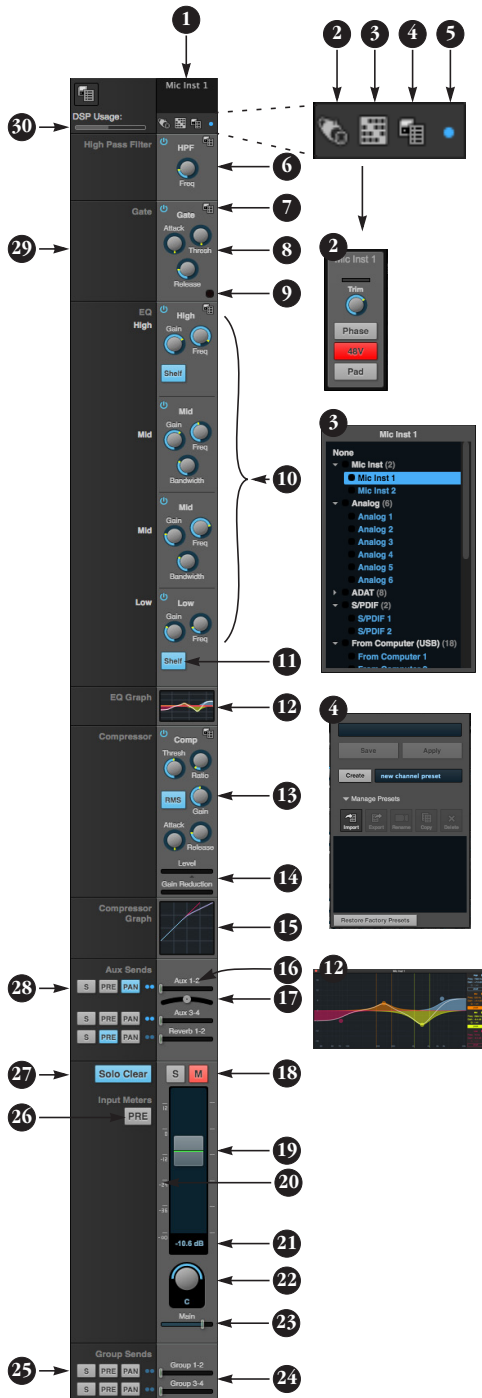

To access a mixer input channel strip, go to the Mixing tab (page 16), reveal the side bar (item #3 on page 16), and then show the input channel you want in the *Mixer Inputs* section (31).

To show and hide sections of the channel strip, such as EQ or the compressor, use the *Controls* section of the side bar (item #3 in the Mixing tab on page 16).

1. Click the input channel name to change it. Delete the current name to restore the default name.

2. Provides hardware settings for inputs, if any, such as preamp gain. If there are no hardware settings for the assigned input, this icon is grayed out.

3. Choose the source for the input channel. You can also make this setting directly on the Routing grid (page 15).

4. Create, name, save and recall channel strip presets.

5. Toggles the input between mono and a stereo pair.

6. High Pass Filter with cutoff frequency.

7. Each effect in the channel strip (High Pass Filter, Gate, EQ, etc.) has an on/off button on the left and a preset menu on the right, for managing presets that apply only to that processing module. For example, you can create your own EQ presets for the EQ modules.

8. The Gate processor provides standard attack, threshold and release controls.

9. The Gate indicator turns red when the gate is engaged.

10. The EQ section provides four bands of parametric EQ, each with standard Gain, Frequency, and Bandwidth settings.

11. The High and Low EQ bands provide a Shelf filter button for standard high and low shelf filtering.

12. The thumbnail EQ Graph displays the currently enabled EQ filters, if any. Click it to open the full-size, editable EQ Graph (Figure 8-4 on page 55).

13. The Compressor provides standard controls for Threshold, Ratio, Attack, Release and Gain. Normally, the compressor operates in Peak mode, where signal peaks determine the input level. Engage the RMS button to use RMS values (a computational method for determining overall loudness) to measure the input level.

14. Input level and gain reduction meters for the compressor.

15. The thumbnail Compressor Graph provides a graphic representation of the compressor, when enabled. Click it to open the full-size, editable Compressor Graph (Figure 8-6 on page 56).

16. Aux 1-2 send.

17. Pan for the Aux 1-2 send. This is enabled in the Aux mix tab (item #11 on page 17).

18. Solo/Mute. Mute affects all sends as well as the main channel. Pre-fader sends are not affected by Mute.

19. Move the fader to adjust level. Double-click to return to zero (unity gain) or $-\infty$.

20. Click the dB scale numbers to make the fader jump exactly to that level. Click and drag horizontally to jump consecutive faders to the same level.

21. Click to type in an exact dB level.

22. Channel pan. For mono inputs, double-click to center.

23. Main Mix Slider is used to feed signal to the Main Mix. Slider is set to 0 dB by default, so all channel strips are pre-routed to the Main Mix bus. If a channel is being sent to a Group (which will eventually be fed to the Main Mix), drag the slider to $-\infty$ so it is not sent to Main Mix directly.

24. Group sends.

25. 'S' lets you solo the group. 'PRE' toggles the sends between pre- and post-fader routing, i.e. before or after the channel fader.

26. The input level meter (behind the fader handle, 19) can display either pre- or post-fader levels. Toggle here.

27. Clears all solos.

28. 'S' lets you solo the Aux bus. 'PRE' toggles the sends between pre- and post-fader routing, i.e. before or after the channel fader. The dots let you toggle the Aux bus between mono and stereo.

29. This side bar, with the section labels in it, can be shown or hidden using the *Legend* switch in the *Controls* section of the side bar (item #3 in the Mixing tab on page 16).

30. Shows how much DSP power is being used by the mixer hardware. To free up DSP bandwidth, try reducing the number of mixer ins, disabling channel effects, reverb, etc. See "DSP Usage" on page 59 for more info.

MAIN MIX AND MONITOR CHANNEL STRIPS

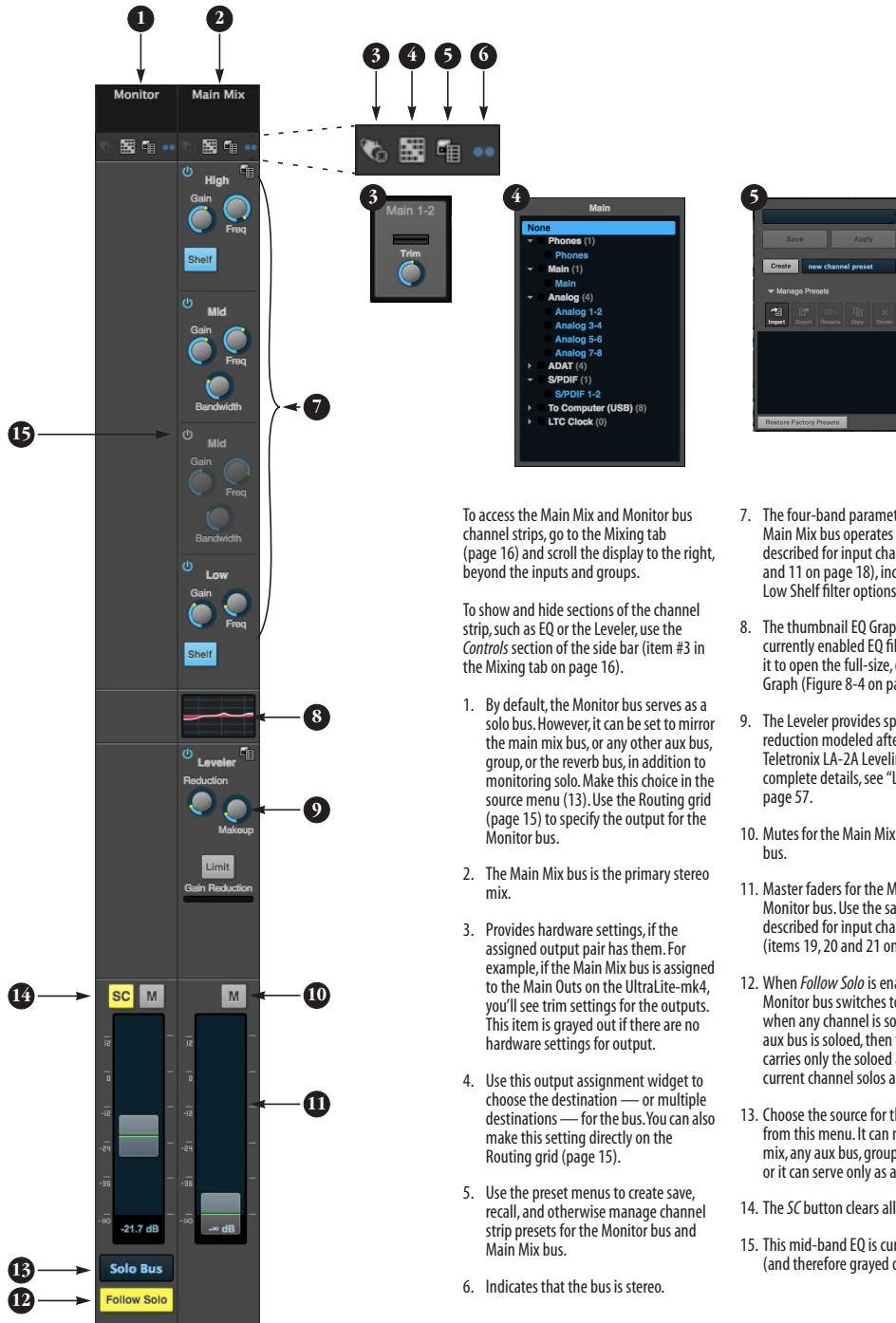

To access the Main Mix and Monitor bus channel strips, go to the Mixing tab (page 16) and scroll the display to the right, beyond the inputs and groups.

To show and hide sections of the channel strip, such as EQ or the Leveler, use the *Controls* section of the side bar (item #3 in the Mixing tab on page 16).

1. By default, the Monitor bus serves as a solo bus. However, it can be set to mirror the main mix bus, or any other aux bus, group, or the reverb bus, in addition to monitoring solo. Make this choice in the source menu (13). Use the Routing grid (page 15) to specify the output for the Monitor bus.
2. The Main Mix bus is the primary stereo mix.
3. Provides hardware settings, if the assigned output pair has them. For example, if the Main Mix bus is assigned to the Main Outs on the UltraLite-mk4, you'll see trim settings for the outputs. This item is grayed out if there are no hardware settings for output.
4. Use this output assignment widget to choose the destination — or multiple destinations — for the bus. You can also make this setting directly on the Routing grid (page 15).
5. Use the preset menus to create, save, recall, and otherwise manage channel strip presets for the Monitor bus and Main Mix bus.
6. Indicates that the bus is stereo.

7. The four-band parametric EQ for the Main Mix bus operates the same as described for input channels (items 10 and 11 on page 18), including High and Low Shelf filter options.
8. The thumbnail EQ Graph displays the currently enabled EQ filters, if any. Click it to open the full-size, editable EQ Graph (Figure 8-4 on page 55).
9. The Leveler provides specialized gain reduction modeled after the legendary Teletronix LA-2A Leveling Amplifier. For complete details, see "Leveler" on page 57.
10. Mutes for the Main Mix bus and Monitor bus.
11. Master faders for the Main Mix bus and Monitor bus. Use the same techniques described for input channel faders (items 19, 20 and 21 on page 18).
12. When *Follow Solo* is enabled, the Monitor bus switches to the solo bus when any channel is soloed. NOTE: if an aux bus is soloed, then the Monitor bus carries only the soloed aux bus (any current channel solos are excluded).
13. Choose the source for the Monitor bus from this menu. It can mirror the main mix, any aux bus, group, the reverb bus, or it can serve only as a Solo bus.
14. The SC button clears all solos.
15. This mid-band EQ is currently disabled (and therefore grayed out).

AUX BUS CHANNEL STRIPS

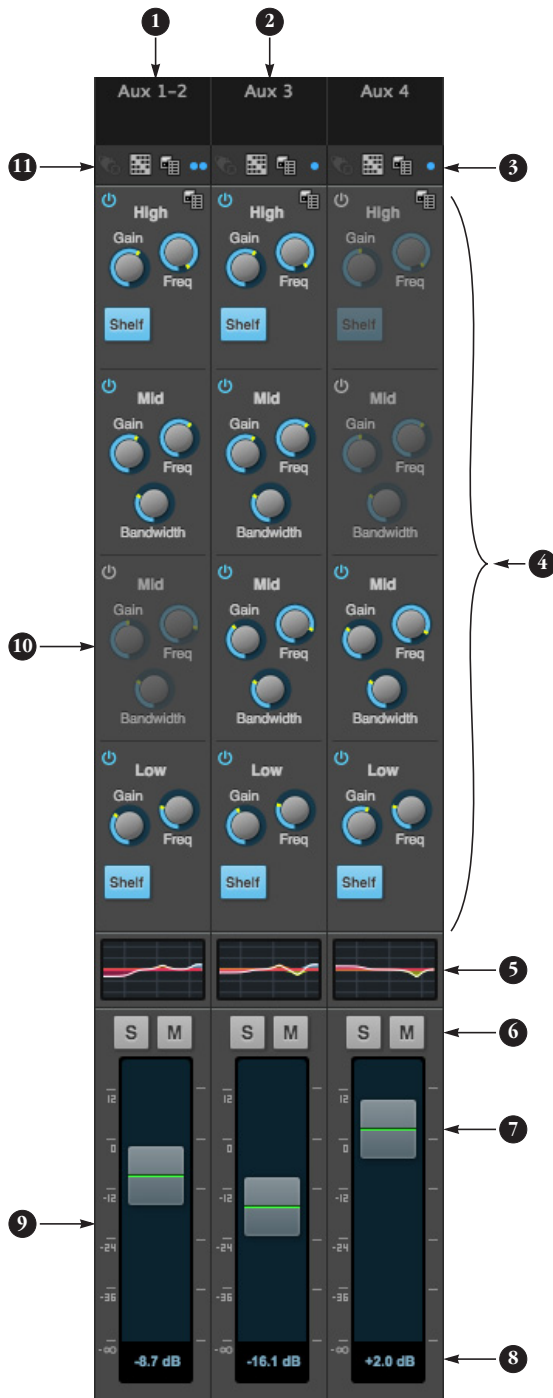

Aux busses can be used to create sub-mixes. An aux bus can be assigned to any output in the Routing grid (page 15).

To access an Aux bus channel strip, go to the Mixing tab (page 16), reveal the side bar (item #3 on page 16), and then show the aux busses you want in the *Mixer Outputs* section (28).

To show and hide the four-band EQ section of the channel strip, use the *Controls* section of the side bar (item #3 in the Mixing tab on page 16).

1. A stereo aux bus.
2. A mono aux bus.
3. Click this dot to toggle an aux bus between mono and stereo.
4. The four-band parametric EQ module for Aux busses operates the same as described for input channels (items 10 and 11 on page 18), including High and Low Shelf filter options.
5. The thumbnail EQ Graph displays the currently enabled EQ filters, if any. Click it to open the full-size, editable EQ Graph (Figure 8-4 on page 55).
6. Aux bus solo and mute.
7. Aux bus master fader.
8. Click to type specific value manually.
9. Click the dB scale numbers to make the fader jump exactly to that level. Click and drag horizontally to jump consecutive faders to the same level.
10. A disabled EQ band.
11. Use these menus (hardware settings, output assignment, and presets) in a similar fashion as described for the Main Out bus (items 3-5 on page 19).

GROUP AND REVERB CHANNEL STRIPS

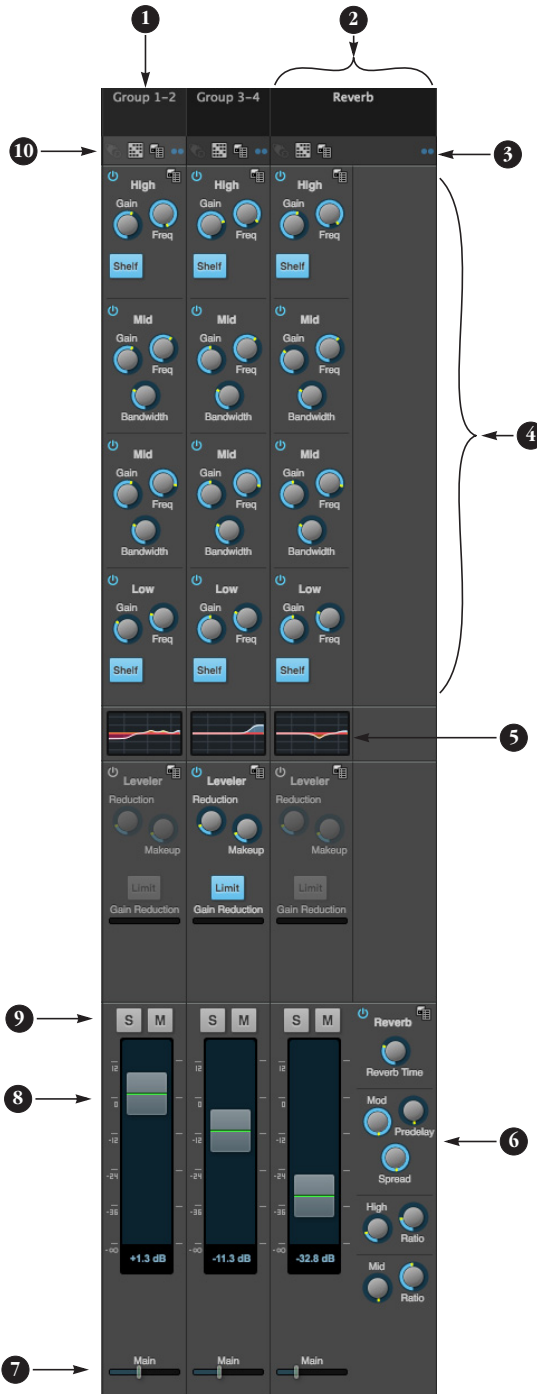

Group busses can be used to create a mix sub-group, which is a set of inputs you wish to control together as a group. Groups differ from aux busses in that they have aux sends, a reverb send, as well as a main mix send. In addition, group busses are equipped with the Leveler.

The Reverb bus is a special group bus that provides a reverb processor. If you disable the reverb, the reverb bus functions as a (fourth) regular group bus.

To access the Group and Reverb bus channel strips, go to the Mixing tab (page 16), reveal the side bar (item #3 on page 16), and then show the desired Group busses or Reverb bus in the *Mixer Outputs* section (28).

To show and hide the four-band EQ section of the channel strip, use the *Controls* section of the side bar (item #3 in the Mixing tab on page 16).

1. A Group bus channel strip. Click the name to rename it. Delete the current name to return to its default.
2. The Reverb bus. If you disable the Reverb processor, it can be used as a fourth Group bus. The Reverb channel strip is twice as wide as other mixer channel strips to accommodate the Reverb processor controls.
3. Group busses and the Reverb bus are always stereo.
4. The four-band parametric EQ module for Group busses and the Reverb bus operates the same as described for input channels (items 10 and 11 on page 18), including High and Low Shelf filter options.
5. The thumbnail EQ Graph displays the currently enabled EQ filters, if any. Click it to open the full-size, editable EQ Graph (Figure 8-4 on page 55).
6. The Reverb processor. For complete information, see “Reverb” on page 58.
7. Main Mix sends.
8. Master faders for the Group and Reverb busses.
9. Mute and Solo.
10. Use these menus (hardware settings, output assignment, and presets) in a similar fashion as described for the Main Out bus (items 3-5 on page 19).

CHAPTER 1 About the UltraLite-mk4

The UltraLite-mk4 is an 18 x 22 USB audio interface with console-style 48-channel mixing, DSP effects, wireless control, and very high quality A/D/A conversion at sample rates up to 192 kHz for on-the-go mobile audio recording.

Powerful DSP delivers large console style mixing with 48 channels, 12 stereo busses, and 32-bit floating point effects processing, including modeled analog EQ, vintage compression and classic reverb. Matrix routing lets you quickly patch ins to outs, or split inputs to multiple destinations.

The UltraLite-mk4 can operate as an audio interface for a studio workstation (DAW), as a standalone mixer, or as an auxiliary monitor mixing system in the studio or on stage. This chapter provides a brief overview of its main features and characteristics.

Comprehensive I/O

The UltraLite-mk4 provides a variety of analog and digital interconnects, all active simultaneously, designed to provide everything you need for a well-equipped mobile recording studio.

Connection	Input	Output
Quarter-inch analog on bal/unbal TRS	6	10
Mic/guitar inputs on combo XLR/TRS	2	-
Headphone output	-	1 x stereo
S/PDIF digital I/O on RCA	2	2
ADAT optical digital (at 44.1 or 48 kHz)	8	8
Total	18	22

Universal connectivity

The UltraLite-mk4 can connect to a computer with high-speed USB 2.0, which is compatible with USB 3.0. It is USB audio class-compliant, which means that it is iPad compatible (with a camera connection kit) and does not require driver installation for USB connection to a computer.

On-board DSP with mixing and effects

The UltraLite-mk4 is equipped with a powerful DSP engine that drives both an extensive routing matrix and a 48-input digital mixer with 12 stereo busses and effects. The mixer offers familiar operation modeled after large format mixing consoles.

32-bit floating point processing

All of the mixing and effects processing in the DSP engine is handled with 32-bit floating point calculations, to maintain and deliver virtually unlimited headroom and the utmost in sound quality.

Modeled vintage effects processing

Effects include “classic” reverb, compression modeled after the legendary Teletronix LA-2A compressor, and 4-band EQ modeled after British analog console EQs.

Matrix routing and multing

The UltraLite-mk4 provides completely flexible matrix-style audio routing and multing. You can route any analog or digital input or computer channel to any other output or the computer. You can also mult any single input to unlimited multiple output destinations.

Web app control

You can control the UltraLite-mk4's on-board DSP, mixing, device settings and clock/sync settings from the MOTU Pro Audio Control web app software running in your favorite browser on a connected computer or laptop, or from a tablet or smart phone on the same Wi-Fi network as the computer. Multiple devices can be used simultaneously to access any audio interface settings on the network.

Live mixing with wireless control

With a connected laptop and shared Wi-Fi network, you can control the UltraLite-mk4's powerful mixing and DSP effects from your smart phone or tablet — great for live sound mixing from your iPad, tablet, or other wireless device.

ADAT digital input

The UltraLite-mk4 provides 8-channel optical digital I/O. Connect outboard digital processors, digital mixers or other gear: 8 channels at 44.1/48 kHz or 4 channels at 88.2/96 kHz. Alternately, the optical ports can be independently configured to support stereo TosLink (optical S/PDIF).

S/PDIF digital I/O

The UltraLite-mk4 provides stereo S/PDIF digital input and output on standard RCA connectors.

MIDI I/O

The UltraLite-mk4's standard MIDI IN and MIDI OUT jacks supply 16 channels of MIDI I/O to and from the computer through its USB connection.

Comprehensive metering

The large backlit LCD displays all signal activity at a glance with detailed metering for all I/O. You can access many hardware settings directly from the front panel.

Headphone output

The UltraLite-mk4 front panel provides an independent headphone jack with separate volume control. You can program the phones to mirror another set of outputs or act as its own independent output.

Precision Digital Trim™

Analog inputs are equipped with digitally controlled analog trims, adjustable in 1 dB increments. Analog outputs offer 32-bit trim in the DAC, also adjustable in 1 dB increments. You can save your trim configurations as a preset for instant recall.

Rack mount or desktop operation

The UltraLite-mk4 is housed in a sturdy, metal-alloy half-rack enclosure. Rack mounting brackets are included for mounting side by side with any other MOTU half-rack unit.

AudioDesk

AudioDesk is a full-featured audio workstation software package for Mac and Windows that is available as a free download for you as an UltraLite-mk4 owner. Visit motu.com/download to obtain your copy. AudioDesk provides multi-channel waveform editing, automated virtual mixing, graphic editing of ramp automation, real-time effects plug-ins with crossfades, support for many third-party audio plug-ins, sample-accurate editing and placement of audio, and more.

CHAPTER 2 **Packing List and System Requirements**

PACKING LIST

the UltraLite-mk4 ships with the items listed below. If any of these items are not present in the box when you first open it, please immediately contact your dealer or MOTU.

- One audio interface
- One USB cable
- One DC power adapter
- One rack mounting kit with brackets and screws
- One manual
- Product registration card

SYSTEM REQUIREMENTS

- A 1 GHz Intel-based Mac or Pentium-based PC (or compatible). Faster CPUs are recommended for best performance.
- 2 GB RAM; 4 GB or more recommended.
- OS X 10.8 or later; Windows 7 or later.
- Available high-speed USB 2.0 (or 3.0) port.
- A large hard drive (preferably at least 500 GB).

PLEASE REGISTER TODAY!

Please register the UltraLite-mk4 today. There are two ways to register.

- Visit www.motu.com/register

OR

- Fill out and mail the included product registration card

As a registered user, you will be eligible to receive technical support and announcements about product enhancements as soon as they become available. Only registered users receive these special update notices, so please register today.

Thank you for taking the time to register your new MOTU products!

CHAPTER 3 **Software Installation**

OVERVIEW

USB 2.0 class-compliant operation.....	27
Software installation.....	27
Audio drivers	27
MOTU Discovery app	28
MOTU Pro Audio WebUI Setup for Windows	28
MIDI I/O on Windows	29
MIDI I/O setup on the Mac	29
AudioDesk workstation software	30
Working with host audio software.....	30

USB 2.0 CLASS-COMPLIANT OPERATION

The UltraLite-mk4 is a USB 2.0 audio class-compliant device. This means that you can connect it to your Mac (running OS X 10.8 or higher) with a USB cable and use it without installing any software drivers. The computer recognizes the UltraLite-mk4 as a USB audio device and makes its inputs and outputs available to your host audio software. Basic settings, such as the hardware's sample rate, are made in either your host software (Mac) or your system settings (Windows).

☛ In this scenario, the UltraLite-mk4 provides basic audio input and output, and no software driver installation is necessary. However, if you want access to the UltraLite-mk4's device settings and mixing capabilities, you will need to run the software installer, as explained in the next section.

Connection to iOS devices (iPad and iPhone)

Audio-class compliant operation allows you to connect the UltraLite-mk4 to any iOS device with a standard camera connection kit adapter. The UltraLite-mk4 then provides multi-channel audio I/O to your audio apps. Use your audio app to configure the number of available audio channels.

SOFTWARE INSTALLATION

If you don't want to operate the UltraLite-mk4 as a USB audio class compliant device, install the software as follows.

Download and run the MOTU Pro Audio Installer

To download the latest MOTU Pro Audio installer for Mac or Windows, visit www.motu.com/ download. Follow the directions that the installer gives you.

☛ We recommend that you run the software installer *before* you connect the UltraLite-mk4 to your computer and power it on. This ensures that all driver components are properly installed in your system.

AUDIO DRIVERS

The installer provides USB audio drivers for Mac (CoreAudio) and Windows (ASIO and Wave).

Industry-leading I/O latency performance

On OS X and Windows, the MOTU Pro Audio driver provides exceptionally low I/O latency performance for USB operation. For example, with a 32-sample host buffer size and a sample rate of 96 kHz, the UltraLite-mk4 produces round trip latency (RTL) performance of 1.83 milliseconds (ms) over USB on OS X and 1.84 ms on Windows. RTL is the measurement of the time it takes audio to pass from an analog input, through a high-performance DAW host such as Digital Performer, to an analog output.

MOTU Pro Audio ASIO Driver

On Windows, to enable the UltraLite-mk4 in your ASIO host software, choose the MOTU Pro Audio ASIO driver.

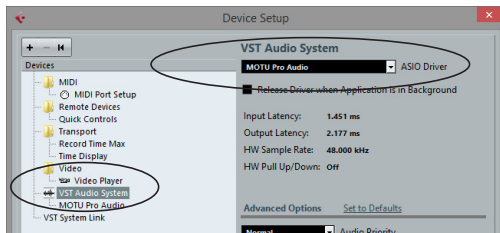

Figure 3-1: Choosing the MOTU Pro Audio ASIO driver in Cubase.

WDM / Wave driver support

On Windows, the MOTU Pro Audio driver includes stereo and multi-channel support (up to 24 channels) for WDM (Wave) compatible audio software.

Host Buffer Size

When connected to a Windows host, the *Host Buffer Size* menu (Figure 3-2) is available in the Device tab (page 12). This setting determines the amount of latency (delay) you may hear when live audio is patched through your Windows audio software. Smaller buffer sizes produce lower latency, with sizes of 256 samples or less producing virtually imperceptible delay. Many host applications report audio hardware I/O latency, so you can see what happens to the reported latency when making adjustments to this setting.

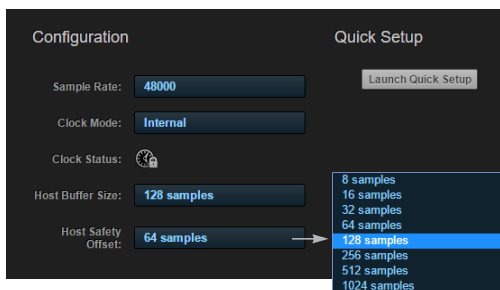

Figure 3-2: Access the 'Host Buffer Size' and 'Host Safety Offset' settings in the web app Device tab for your MOTU interface.

Be careful with very small buffer sizes, as they can cause performance issues from your host software or PC.

At sea level, audio travels approximately one foot (30 cm) per millisecond. A latency of ten milliseconds is about the same as being ten feet (three meters) from an audio source.

Host Safety Offset

When connected to a Windows host, the *Host Safety Offset* menu (Figure 3-2) also becomes available. This setting allows you to fine tune host latency. Larger offsets allow the driver more time to process audio as it transfers to and from the hardware. Lower settings produce lower latency, but if you go too low, your host software may experience performance issues. Generally speaking, 48 samples should serve as a good baseline setting. You can then experiment with lower settings from there. Be mindful, however, when reducing the safety offset, as this parameter can have a significant impact on your computer system's performance.

MOTU DISCOVERY APP

The MOTU Discovery app (found in the Mac menu bar or Windows taskbar) locates all MOTU interfaces connected to the computer, either directly through USB or on your network, and displays them in a list. Choose the UltraLite-mk4 (or another interface) to access its settings through the web app ("MOTU Pro Audio Control Web App" on page 11).

MOTU PRO AUDIO WEBUI SETUP FOR WINDOWS

On Windows, the installer provides a *MOTU Pro Audio WebUI Setup* shortcut found on the Windows desktop or in *Start menu > All Programs > MOTU*. Use this shortcut to access the MOTU Pro Audio Control web app directly in your favorite web browser.

MIDI I/O ON WINDOWS

On Windows, the MOTU Pro Audio Installer provides a USB MIDI driver for the UltraLite-mk4. This driver allows you to access the UltraLite-mk4's MIDI input and output ports through its USB connection to the computer. The ports are published in Windows and are available to all MIDI software.

MIDI I/O SETUP ON THE MAC

Core MIDI is the “under-the-hood” component of Mac OS X that handles MIDI services for MIDI hardware and software. Core MIDI provides many universal MIDI system management features, including MIDI communication between your UltraLite-mk4 interface and all Core MIDI compatible software.

Audio MIDI Setup is a utility included with Mac OS X that allows you to configure your UltraLite-mk4 interface for use with all Core MIDI compatible applications. Audio MIDI Setup provides:

- A “virtual” studio on your Mac that graphically represents your MIDI hardware setup and that is shared by all Core MIDI-compatible programs
- A simple, intuitive list of your MIDI devices whenever you need it in any Core MIDI-compatible program

Launching Audio MIDI Setup

- 1 Make sure your UltraLite-mk4 interface is connected (a USB connection is required) and turned on.
- 2 Launch the Audio MIDI Setup utility.

This can usually be found in /Applications/Utilities. If it has been moved, just search for *Audio MIDI Setup*.

- 3 Confirm that the MIDI interface is present in the *MIDI Devices* tab (or window) in Audio MIDI Setup. If the interface does not appear, or if it is grayed out, check your cable connections and click *Rescan MIDI*.

Connecting MIDI devices to the UltraLite-mk4

Once your UltraLite-mk4 interface appears in Audio MIDI Setup, you are ready to add devices, indicate how they are connected, and identify properties they may have for particular purposes. This information is shared with all Core MIDI compatible applications.

To add a device in Audio MIDI Setup:

- 1 Click *Add Device*.
- 2 Drag on its input and output arrows to draw connections to the UltraLite-mk4 that match its physical connection.

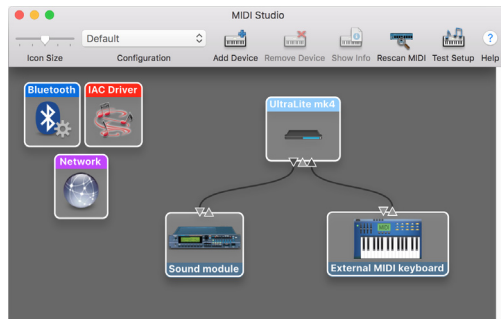

Figure 3-3: Connecting devices to the UltraLite-mk4. In this example, a controller keyboard is connected to the UltraLite-mk4's MIDI IN, and a sound module is connected to the UltraLite-mk4 MIDI OUT.

- 3 Double-click the device to make settings, such as input and output channels, that further describe the device.

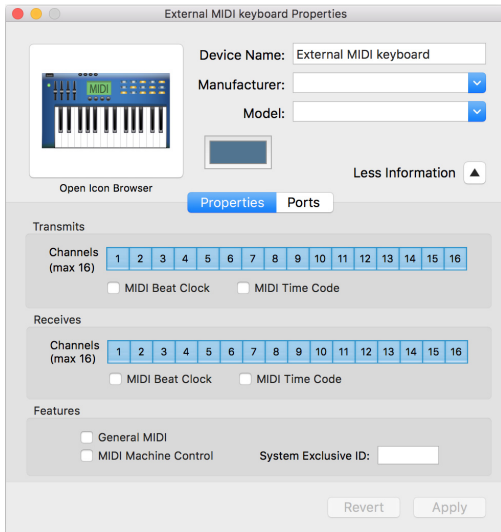

Figure 3-4: Device settings.

- 4 Repeat the above steps for each MIDI device connected to the interface.
- 5 When you are finished, quit Audio MIDI Setup.

Your configuration is automatically saved as the default configuration, and it is shared with all Core MIDI-compatible software.

AUDIODESK WORKSTATION SOFTWARE

AudioDesk is an advanced workstation software package for Mac and Windows that lets you record, edit, mix, process, bounce and master multi-track digital audio recording projects. Advanced features include real-time effects processing, recording, and much more.

See the *AudioDesk User Guide*, available on your computer hard drive as a PDF document.

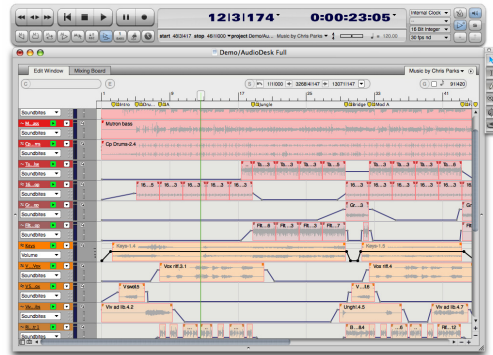

Figure 3-5: AudioDesk.

WORKING WITH HOST AUDIO SOFTWARE

For further information about using the UltraLite-mk4 with host audio software, see “Working with Host Audio Software” on page 45.

CHAPTER 4 Hardware Installation

OVERVIEW

USB audio interface setup 31
iOS audio interface setup 31
A typical UltraLite-mk4 setup 32
Audio connections 33
MIDI connections 35
Syncing to SMPTE time code (LTC) 35

USB AUDIO INTERFACE SETUP



Use this setup if you want to use the UltraLite-mk4 as a USB audio interface.

- Use a standard USB cable.
- Connect to any USB port (USB2.0 or 3.0).
- See chapter 3, “Software Installation” (page 27).

iOS AUDIO INTERFACE SETUP



Use this setup if you want to use the UltraLite-mk4 as an iOS audio interface.

- Use a standard iOS camera connection kit (adapter).
- Use any standard USB cable.
- See chapter 3, “Software Installation” (page 27).

A TYPICAL ULTRALITE-MK4 SETUP

Here is a typical UltraLite-mk4 setup. All mixing and effects processing can be done in the

UltraLite-mk4 itself, controlled from your laptop, tablet, and smart phone — or several devices simultaneously.

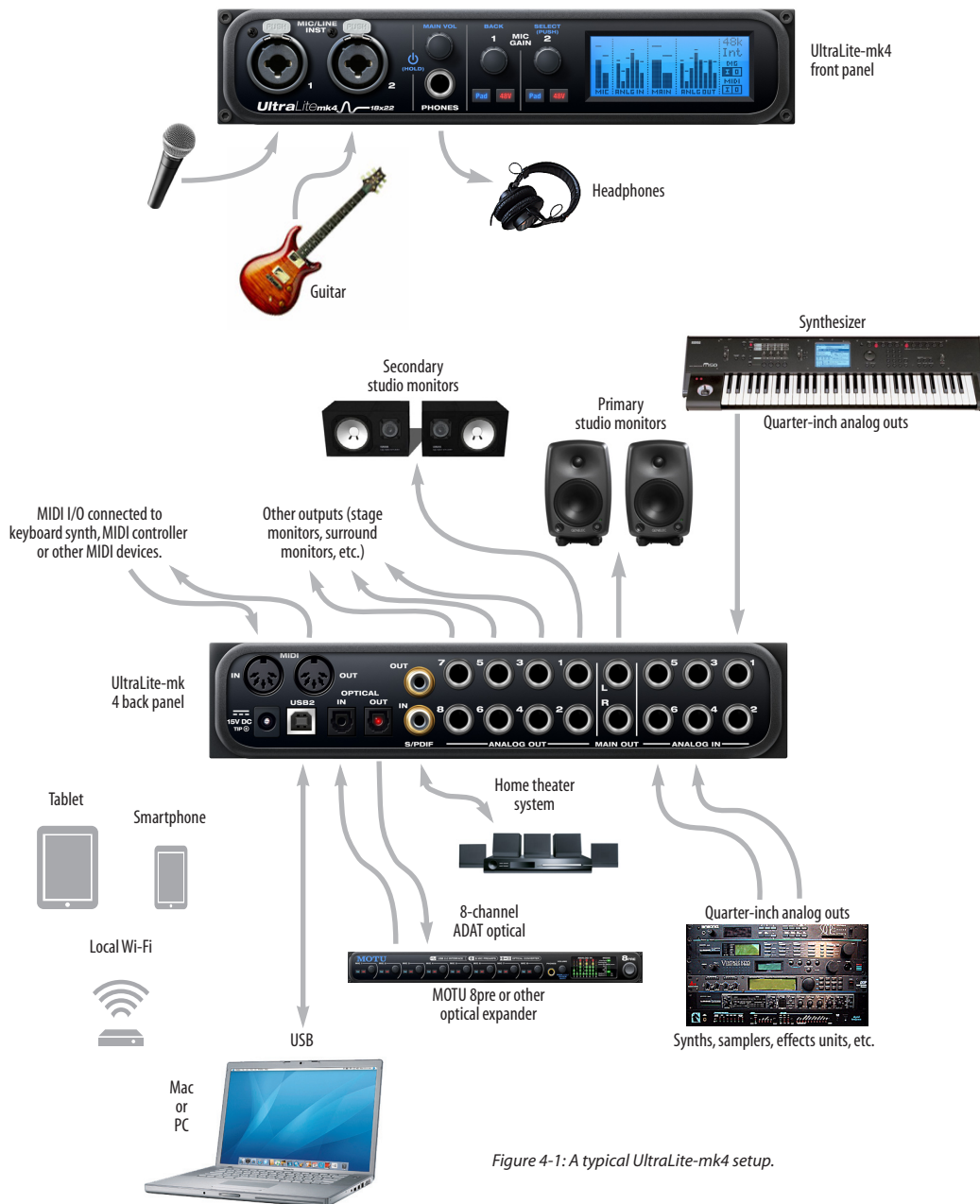

Figure 4-1: A typical UltraLite-mk4 setup.

AUDIO CONNECTIONS

Here are a few things to keep in mind as you are making audio connections to your UltraLite-mk4 interface.

Mic/instrument inputs with preamps

Connect a microphone, guitar, instrument or other analog input to the XLR/TRS combo jack with either a standard mic cable or a balanced cable with a quarter-inch plug.

☛ Do not connect a +4 dBu (line level) signal to the mic/guitar inputs without using the -20dB Pad. It is recommended you connect line level signals to the quarter-inch inputs on the rear panel instead.

-20 dB pad

Each mic/guitar input is equipped with a -20 dB pad switch, to accommodate input signals that could overdrive the input.

Phantom power

If you are connecting a condenser microphone or another device that requires phantom power, engage the mic input's corresponding front-panel phantom power button.

Preamp gain

The XLR input on each combo jack feeds an independent preamp, which provides +60 dB of gain. Use the front panel detented trim knobs to adjust gain as needed for each input. The LCD provides visual feedback as you turn the trim knob. Preamp gain is digitally controlled, so you can make fine-tuned adjustments in 1dB increments. You can also adjust preamp gain in the web app. See “Device tab” on page 12.

Independent volume control for the instrument input

When a quarter-inch plug is inserted into the quarter-inch combo jack, its signal bypasses the preamp. The gain knob on the front panel (and in the Device tab of the web app) provides independent volume control for the quarter-inch

input, which is adjusted and saved separately from the preamp gain setting for the XLR mic input. The volume range for the instrument input is zero to +30 dB.

TRS quarter-inch analog inputs and outputs

Quarter-inch analog inputs and outputs are balanced (TRS) connectors that can also accept an unbalanced plug.

☛ Quarter-inch analog outputs are not cross-coupled. Therefore, when connecting them to an unbalanced input, use a TRS plug with the ring disconnected. Not floating the negative terminal will short it to the sleeve ground and cause distortion.

Dedicated main outs

Like all I/O on the UltraLite-mk4, the main outputs operate as an independent pair (they don't share signal with any other output pair). In a standard studio configuration, the main outs are intended for a pair of studio monitors, but they can also be used as regular outputs for any purpose. With adjustable converter trim, they support a wide range of industry-standard reference levels. Main out volume is controlled by the MAIN VOL knob on the front panel: push it repeatedly until you see *Main 1-2* in the LCD and then turn it to adjust the master volume output.

Analog trims

All quarter-inch analog inputs and outputs can be trimmed. This allows them to support a variety of standards, including EBU-R68, SMPTE RP-155, +4dBu, -10dBV, 2vRMS, 1vRMS.

The UltraLite-mk4's quarter-inch analog inputs are equipped with high-quality, digitally controlled analog trim that provides a range from -96 to +22 dB in 1dB steps.

Quarter-inch outputs can be trimmed in the DAC itself. Range is 24 dB. The Main Outs and Phones provide full trim range from 0 dB to $-\infty$ (-127).

Trim controls are most easily accessed in the web app. See “Device tab” on page 12. Trim settings can also be accessed in the LCD menu.

Optical I/O

The UltraLite-mk4 provides ADAT optical (“lightpipe”) connectors (one input and one output). Together, they provide 8 channels of ADAT optical digital I/O at 44.1 or 48 kHz, or 4 channels of SMUX optical at 2x sample rates (88.2 or 96 kHz). SMUX operation supports two modes (item #21 on page 13):

- *Standard* — for 2x optical connection to 3rd-party SMUX-compatible hardware products.
- *Type II (Legacy)* — for 2x optical connection to legacy MOTU products that are equipped with optical ports and support 2x operation.

The optical ports are disabled when the interface is operating at a 176.4 or 192 kHz.

TOSLink (optical S/PDIF)

Alternately, the optical ports can be configured for stereo TOSLink (optical S/PDIF) in the web app (item #21 on page 13). The optical IN and OUT banks can be configured independently.

Choosing a clock source for optical connections

When connecting an *optical* device, make sure that its digital audio clock is phase-locked (in sync with) the UltraLite-mk4. There are two ways to do this:

- Resolve the optical device to the UltraLite-mk4
- Resolve the UltraLite-mk4 to the optical device

For A, choose *Internal* (or anything other than *Optical*) as the clock source in the Device tab (item #13 on page 12). Then configure the other device to resolve to its optical input.

For B, choose *Optical* as the clock source (item #13 on page 12), and configure the other device to resolve to its own internal clock.

S/PDIF

If you make a S/PDIF digital audio connection to another device, the UltraLite-mk4 must be digitally synced with the other device for a clean, click-free digital audio stream between them.

DAT decks and other devices with S/PDIF digital I/O will sync to the UltraLite-mk4 input via the S/PDIF connection itself. Just connect it to the UltraLite-mk4 S/PDIF output connector. When the device records a digital audio signal (from the UltraLite-mk4), it will simply synchronize to the clock provided by the signal.

When you transfer audio from the S/PDIF device into the UltraLite-mk4, you’ll have to resolve the UltraLite-mk4 to its S/PDIF input.

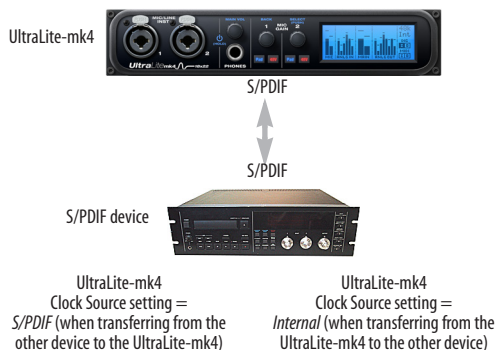

Figure 4-2: The setup for synchronizing a S/PDIF device with the UltraLite-mk4. Sync is achieved via the digital I/O connection itself. In this case, you have to choose S/PDIF as the UltraLite-mk4’s clock source when recording from the other device.

MIDI CONNECTIONS

The UltraLite-mk4 provides MIDI I/O to the computer over USB. Connect your MIDI device's MIDI IN jack to the UltraLite-mk4's MIDI OUT jack (Connection A below). Conversely, connect the MIDI device's MIDI OUT jack to the UltraLite-mk4's MIDI IN jack (Connection B).

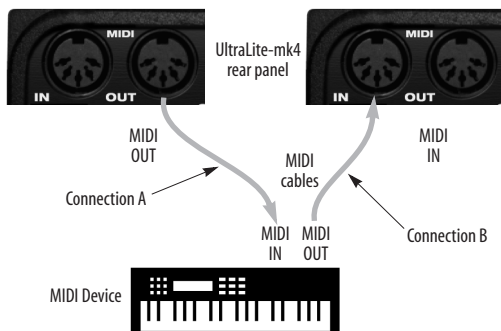

Figure 4-3: Connecting a MIDI device to the UltraLite-mk4.

One-way MIDI connections

MIDI devices that do not receive MIDI data, such as a dedicated keyboard controller, guitar controller, or drum pad, only need Connection B shown in Figure 4-3. Similarly, devices that never send data, such as a sound module, only need Connection A. Make both connections for any device that needs to both send and receive MIDI data.

Connecting additional gear with MIDI THRU

If you need to connect several pieces of MIDI gear, run a MIDI cable from the MIDI THRU of a device already connected to the UltraLite-mk4 to the MIDI IN on the additional device as shown below in Figure 4-4. The two devices then share the UltraLite-mk4's MIDI OUT port. This means that they share the same set of 16 MIDI channels, too, so try to do this with devices that receive on only one MIDI channel (such as effects modules), which makes it easier to avoid MIDI channel conflicts.

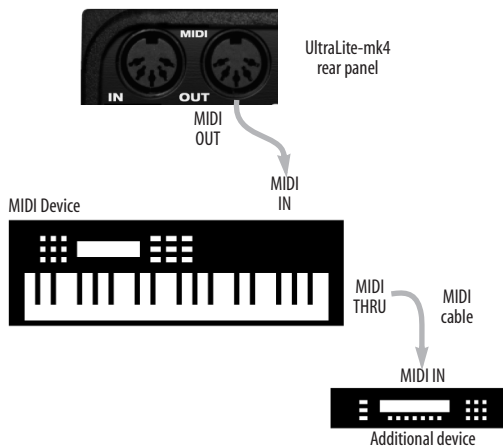

Figure 4-4: Connecting additional devices with MIDI THRU ports.

MIDI Thru when operating stand-alone

The UltraLite-mk4 has a MIDI Thru feature for stand-alone operation. This can be enabled from the front panel LCD Settings menu.

SYNCING TO SMPTE TIME CODE (LTC)

The Clock Mode menu (item #13 on page 12) provides the ability to resolve to SMPTE time code (*Longitudinal Time Code*, referred to as *LTC*) from any specified analog or digital input.

When you choose the LTC clock mode setting, the audio phase lock engine in your MOTU interface resolves to the incoming time code. (See below for how to specify the time code input.) This ensures that audio passing through the interface remains resolved to time code and won't drift over time, as long as the audio is coming from other sources that are also resolved to the same time code. This also ensures that audio recorded by DAW host software on a connected computer, or audio playing back from the DAW, will remain resolved to time code and won't drift over time, even when restarting or cueing the source time code.

Depending on the stability of the incoming time code, it may take a few seconds for your interface to lock to the time code. The more stable the incoming time code, the faster the lock-up time.

SMPTE time code (LTC) settings

There are several settings for the time code features in your MOTU interface. In the web app, go to the Device tab (page 14) and scroll to the LTC Setup section, shown below.

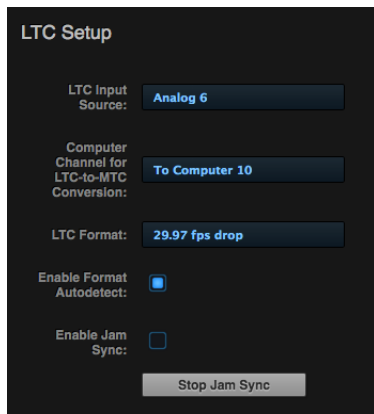

Figure 4-5: Settings for SMPTE time code sync.

LTC Input Source

Choose the input on your interface that is receiving the time code (LTC). Any input can be used, including an analog or digital input.

Computer Channel for LTC-to-MTC Conversion

Choose a computer channel that you aren't using for anything else here. It will be used to transmit LTC from the interface to the computer. If all of your computer channels are being used, you can add extra channels using the *To computer* setting in the Routing tab. See “LTC-to-MTC conversion” on page 51 for further info about LTC-to-MTC conversion.

LTC Format

Choose the frame format that matches the incoming time code.

Enable Format Autodetect

If you would like your MOTU interface to automatically detect the frame format of the incoming time code, check this box.

Enable Jam Sync

When this option is checked, your MOTU interface will continue to convert LTC to MTC even after incoming time code stops being received. Once Jam Sync kicks in, it will continue generating until you click Stop Jam Sync.

Part 2

Using the

UltraLite-mk4

CHAPTER 5 Presets

OVERVIEW

Because of its advanced, extensive feature set, the UltraLite-mk4 can be used for many different purposes. This chapter discusses common use cases and their corresponding device presets, to help you use the hardware for your needs.

Preset menu

The preset menu (item #7 on page 12) contains a number of presets specifically designed for common use cases. By loading the corresponding preset, the UltraLite-mk4's routing tab and mixer will be reconfigured accordingly. You can visit the routing and Mixing tabs to inspect settings and adjust them as needed.

- Audio interface 39
- Interface + mixer..... 40
- Live recording with monitor mixing 40
- Optical converter 40
- Optical converter with mixing 41

Create your own presets

You can create presets to suit your specific needs. The UltraLite-mk4 is highly capable and configurable, allowing it to perform many tasks simultaneously.

AUDIO INTERFACE

Choose the *Audio Interface* preset to use the UltraLite-mk4 as a standard USB or iOS audio interface. Hardware inputs and outputs are accessible from your computer or iOS device, and the routing and mixing features are disabled.

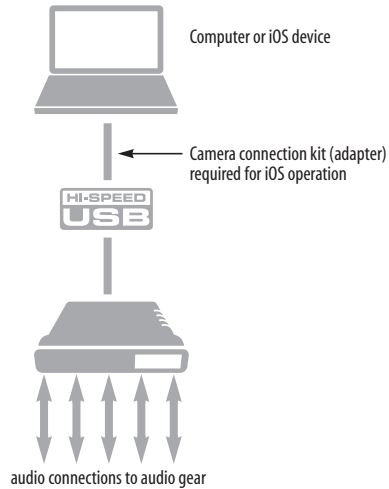

Figure 5-1: Using the UltraLite-mk4 as an audio interface.

INTERFACE + MIXER

Choose the *Interface + Mixer* preset to use the UltraLite-mk4 as both an audio interface and mixer, simultaneously. Doing so routes all physical inputs and outputs to and from the computer, connected through USB. In addition, the following audio sources are routed to the mixer, which mixes them to the Main Mix bus, plus three stereo aux busses for independent monitor mixes:

- The UltraLite-mk4's eight analog inputs
- The UltraLite-mk4's optical inputs
- USB channels from the host computer

The Monitor bus is set up as a solo bus.

In this scenario, you can control the mixer from the MOTU Pro Audio Control web app running on the computer. You can also run the web app from wireless devices on the same Wi-Fi network as the computer.

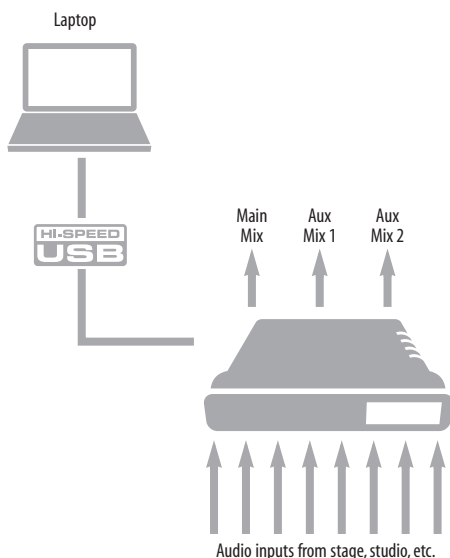

Figure 5-2: Using the UltraLite-mk4 as an audio interface and mixer, simultaneously.

LIVE RECORDING WITH MONITOR MIXING

Choose the *Live recording with monitor mixing* preset when you are tracking in the studio. The setup is pretty much the same as for the “Interface + mixer” preset shown in Figure 5-2 on page 40. All physical inputs on the interface are routed to both the computer (for recording) and the Main Mix and Monitor busses in the mixer (for near-zero latency monitoring). USB channels from the computer are included in the UltraLite-mk4's mix. As with the other presets, aux busses are routed to the UltraLite-mk4's line outs, for independent monitor mixes.

OPTICAL CONVERTER

Choose the *Optical converter* preset if you would like the UltraLite-mk4 to serve as a multi-channel digital-to-analog and analog-to-digital converter connected to another device equipped with an optical port. For example, if you have another MOTU interface equipped with optical, you could connect its optical output banks to the UltraLite-mk4's optical input banks, or vice versa. The UltraLite-mk4 then serves as an 8-channel expander that adds the UltraLite-mk4's analog outputs (and/or inputs) to your setup.

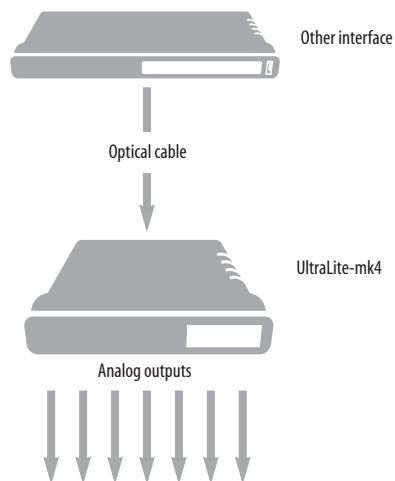

Figure 5-3: Use the *Optical converter* preset to use the UltraLite-mk4 as an optical-to-analog expander for both input and output.

OPTICAL CONVERTER WITH MIXING

The *Optical converter with mixing* preset does not route incoming optical audio directly to the UltraLite-mk4's analog outputs. Instead, this preset routes the incoming optical audio to the mixer. The mixer then distributes separate mixes to the UltraLite-mk4's analog output pairs.

CHAPTER 6 The Front Panel LCD

OVERVIEW

The front panel LCD displays level meters for all analog inputs and outputs and activity indicators for MIDI, optical and S/PDIF I/O. The LCD also provides several navigable menus that provide status information and basic hardware settings.

- Level meters 43
- Push-button Knobs 43
- Power..... 43
- Channel focus 43
- Main volume..... 43
- Menu Navigation 43
- Device menu..... 44
- Settings menu 44
- Presets menu 44
- Version menu..... 44
- Clock..... 44

LEVEL METERS

In its default state when the unit is first powered on, the LCD displays level meter activity for all analog audio inputs and outputs (Figure 6-1).

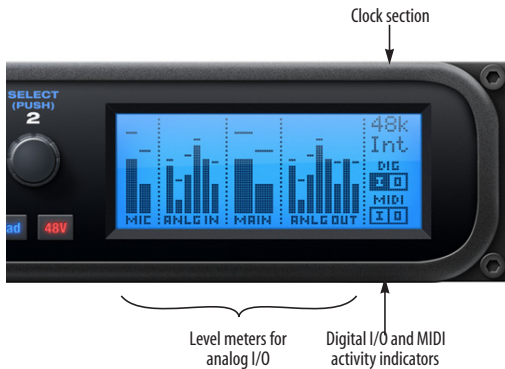

Figure 6-1: Analog metering and activity indicators for MIDI and optical I/O.

PUSH-BUTTON KNOBS

The front-panel knobs (Figure 6-2) are push-button digital rotary encoders. Push the knob for the function labeled in blue.



Figure 6-2: Push the knob to activate the functions labeled in blue.

POWER

Push and hold the power knob (Figure 6-2) to switch the unit on or off. The LCD provides feedback as you hold to power down.

CHANNEL FOCUS

When turning a knob to adjust volume or input gain, the LCD shows the level setting. A few seconds after you stop turning the knob, the LCD returns to the previous display. To temporarily suspend the focus timeout, push the knob while focused. A “pin” icon appears in the LCD to indicate that the focused metering will remain on screen until you push the knob again to dismiss it.

MAIN VOLUME

Push the PHONES volume knob (MAIN VOL) to toggle volume control between the phones and main outs. The LCD provides visual feedback.

MENU NAVIGATION

Push SELECT to access the main menu, which provides settings and status information.

Main Menu

Turn the SELECT knob to scroll through the menu settings.

Push SELECT to enter the selected sub-menu or to select the currently highlighted parameter.

Push BACK to go to the parent menu.

To exit the menu entirely, push BACK repeatedly until the menu disappears from the display.

Device menu

The Device menu provides information about the device, such as its name and connection mode.

Settings menu

The Settings menu provides access to basic hardware settings, such as Clock Mode, Sample Rate, and so on.

Setting	What it does
Clock Mode	Sets the digital audio clock source for the device.
Sample Rate	Sets the sample rate for the device.
Optical	Specifies ADAT or TOSLink, or the SMUX format when operating at 88.2 or 96 kHz. See “Optical I/O” on page 34.
MIDI Thru	When enabled, MIDI data passes directly from the MIDI input to the MIDI output when the UltraLite-mk4 is disconnected from USB (running standalone).
LCD Contrast	Adjusts the contrast of the LCD.
Clear Password	Removes password protection in the web app.
Factory Defaults	Restores factory default settings.

Presets menu

The Presets menu lets you recall settings that have been saved as a *device preset*. Use the web app to create and save presets (item #7 in the “Device tab” on page 12).

Version menu

The Version menu displays firmware version info.

CLOCK

The Clock section of the LCD (Figure 6-1 on page 43) displays the sample rate at which the unit is currently operating, and the current Clock Mode setting (item #13 in the Devices tab on page 12). The Clock Mode setting can also be found (and changed) in the Settings Menu.

CHAPTER 7 Working with Host Audio Software

OVERVIEW

The UltraLite-mk4 provides multi-channel audio input and output for Core Audio compatible audio applications on the Mac and ASIO or Wave compatible applications on Windows, including MOTU's Digital Performer and AudioDesk, Apple's Logic Pro and GarageBand, and other third-party software applications such as Ableton Live, Avid Pro Tools, Cockos Reaper, Propellerhead Reason, Steinberg Cubase and Nuendo, Cakewalk SONAR, PreSonus Studio One, Bitwig, and others.

AudioDesk is available as a free download for UltraLite-mk4 owners at motu.com/download. For complete information about all of AudioDesk's powerful workstation features, refer to the *AudioDesk User Guide.pdf* included in the AudioDesk application.

Digital Performer, MOTU's state-of-the-art digital audio workstation software, is available separately; for details about upgrading from AudioDesk to Digital Performer, talk to your authorized MOTU dealer or visit motu.com.

Preparation	45
Run the web app.....	45
Choose the MOTU Pro Audio driver.....	46
Reducing monitoring latency.....	46
Working with the Routing grid	49
Working with on-board mixing and effects.....	51
LTC-to-MTC conversion	51

PREPARATION

Install your host audio software first if you haven't already done so, and complete these chapters before proceeding:

- chapter 3, "Software Installation" (page 27)
- chapter 4, "Hardware Installation" (page 31)

RUN THE WEB APP

Before you run your host audio software, launch the web app to configure your MOTU hardware.

The web app lets you configure important settings in your audio interface, enable the desired inputs and outputs, and set up audio streams to and from the computer.

Sample rate

Choose the desired sample rate for the UltraLite-mk4 (item #12 in the Device tab on page 12) and your host audio software. Make sure the rates for the hardware and software match. Newly recorded audio will have this sample rate.

Clock mode

The *Clock Mode* setting (item #13 in the Device tab on page 12) is important because it determines the master digital audio clock for your system.

If you do not have any digital audio connections to your MOTU device (you are using the analog inputs and outputs only), and you will not be resolving your host software to optical or another external clock source, choose *Internal*.

If you have devices connected to the optical ports, see "Choosing a clock source for optical connections" on page 34. If you have S/PDIF devices connected, see "S/PDIF" on page 34.

Audio Interface preset

Click *Launch Quick Setup* (item #9 in the Device tab on page 12) and choose the *Audio Interface* preset. Your MOTU interface is now set up for operation as an audio interface with any host audio software. For details about customizing the audio routing to and from the computer, see "Working with the Routing grid" on page 49.

CHOOSE THE MOTU PRO AUDIO DRIVER

Once you've made the preparations described so far in this chapter, you're ready to run your audio software and enable the MOTU Pro Audio driver, which allows your host software to use the UltraLite-mk4 as an audio interface.

For Mac OS X audio software

For audio software running under Mac OS X, go to the menu item or preference where you choose the audio device (Core Audio driver) you wish to use, and then select the UltraLite-mk4 by name.

For Windows audio software

For audio software running under Windows, go to the menu item or preference where you choose the ASIO driver you wish to use, and then choose *MOTU Pro Audio ASIO*. If your host audio software doesn't support ASIO, choose the *MOTU Pro Audio Wave* driver instead.

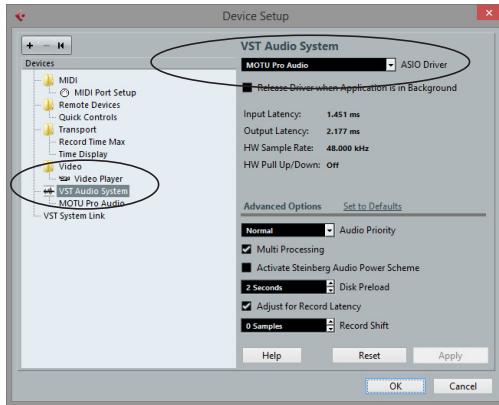

Figure 7-1: Choosing the MOTU Pro Audio ASIO driver in Cubase.

Where to go in popular audio hosts

Here is the location for this setting in various popular audio software host applications:

Host software	Location for choosing the UltraLite-mk4
Digital Performer and AudioDesk	Setup menu > Configure Audio System > Configure Hardware Driver
Pro Tools 9 or later	Setup menu > Playback Engine or Current Engine
Logic Pro	Preferences > Audio tab > Devices tab > Core Audio tab
Garage Band	Garage Band menu > Preferences > Audio/MIDI > Audio Output/Input menus
Cubase and Nuendo	Device Setup > Devices list > VST Audio System menu
Live	Preferences > Audio tab
Reason	Preferences > Audio preferences
Reaper	Preferences > Audio prefs > Devices

Other audio software

Consult your software's manual for further information.

REDUCING MONITORING LATENCY

Monitoring latency is a slight delay caused by running an input signal through your host audio software and back out. For example, you might hear it when you drive a live guitar input signal through an amp modeling plug-in running in your audio sequencer.

This delay is caused by the amount of time it takes for audio to make the entire round trip through your computer, from when it first enters an input on the UltraLite-mk4, passes through the interface hardware into the computer, through your host audio software, and then back out to an output.

Monitoring through the UltraLite-mk4

If you don't need to process a live input with plug-ins, the easiest way to avoid monitoring latency is to disable your DAW's live monitoring feature and instead use the digital mixer in the UltraLite-mk4 to route the input directly to your

outputs. For details, see “Mixing tab” on page 16. The mixer in the UltraLite-mk4 even provides zero latency effects processing (EQ, compression and reverb), which can be applied to the signal.

Direct hardware playthrough / Direct ASIO monitoring

When managing your live monitor mix through the UltraLite-mk4 mixer, remember to disable your DAW’s live monitoring features, so that you won’t hear record-enabled tracks in your DAW. Also note that the UltraLite-mk4 does not support *Direct Hardware Playthrough* in Digital Performer, or the *Direct ASIO Monitoring* feature (or similar) offered and other DAWs, which lets you control no-latency hardware monitoring from within the host application. Instead, you can use the MOTU Pro Audio Control web app mixer (“Mixing tab” on page 16) to make these live monitoring connections manually.

If you don’t require any effects processing on the input signal (no reverb or compression, for example), all this takes is one click in the routing grid to route the input being recorded to the output you are using for monitoring.

If you are recording a mono input that you’d like to monitor in stereo, or if you need to apply effects to the monitored signal, you can simply route the input to the mixer in the UltraLite-mk4. This is done by opening the *Mix In* group in the *Outputs* column along the left side of the grid, and clicking the tile at the intersection of the input’s column and the desired mixer input’s row. Once routed to the mixer, use the input channel, reverb bus, and monitor bus in the mixer to apply effects as desired, and perhaps include other channels to the mix, and then assign the monitor bus output in the routing grid to the output you are using for monitoring.

In either case (routing directly in the grid or routing through the mixer), be sure to maintain the input’s connection to the computer as well, so the

input signal can be recorded in your host software. In other words, you’ll want to make sure there are two tiles enabled in the input’s column in the grid: one tile for the connection to the computer and another tile for your monitoring output (or a mixer input, if you are using the mixer to apply effects). If you need to route the input signal to other destinations, too, you can certainly do so (you can route the input to multiple destinations).

Monitoring through your host audio software

If you *do* need to process a live input with host software plug-ins, or if you are playing virtual instruments live through your MOTU audio hardware, you can significantly reduce latency by adjusting the audio buffer setting in your host audio software, as explained in the next section.

☛ It is important to note that monitoring delay has no effect on the recording, or playback, of audio data from disk. The actual recording and playback is extremely precise, it is only the monitoring of your live input signal which may be delayed.

Adjusting your host software audio buffer

Buffers are small bundles of audio data. The UltraLite-mk4 “speaks” to your computer in buffers, rather than one sample at a time. The size of these buffers determine how much delay you hear when monitoring live inputs through your audio software: larger buffers produce more delay; smaller buffers produce less.

Adjusting buffer size on Mac OS X

Under Mac OS X, audio I/O buffer size is handled by the host audio application (not by the UltraLite-mk4’s Core Audio driver). Most audio software applications provide an adjustable audio buffer setting that lets you control the amount of delay you’ll hear when monitoring live inputs or processing them with software plug-ins. Here are a few examples.

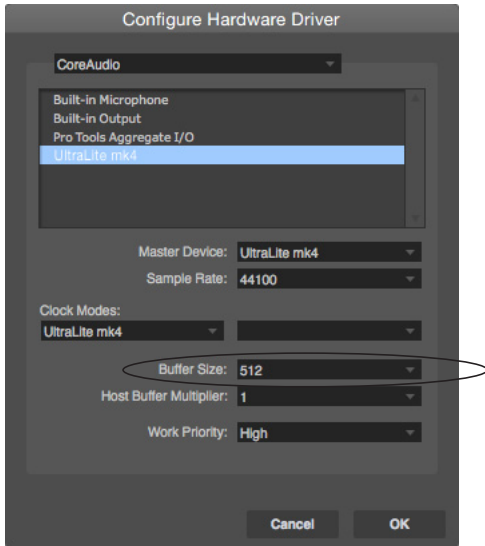

Figure 7-2: In Digital Performer and AudioDesk, choose Setup menu > Configure Audio System > Configure Hardware Driver to open the dialog shown above and access the Buffer Size setting. Refer to your Digital Performer or AudioDesk manual for information about the Host Buffer Multiplier setting.

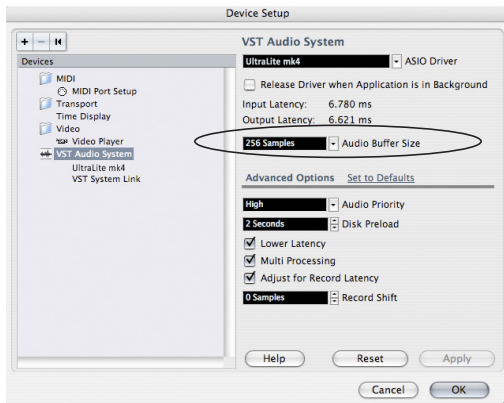

Figure 7-3: In Cubase or Nuendo, choose Devices menu > Device Setup. Select your interface (UltraLite-mk4), then click the Control Panel button to access the window above and the Buffer Size setting.

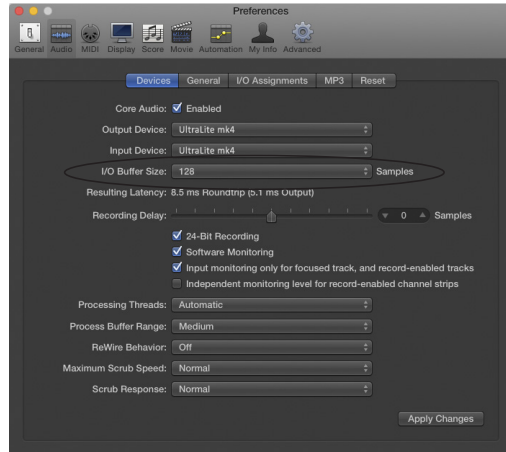

Figure 7-4: In Logic Pro, go to the Audio Driver preferences to access the Buffer Size option shown above.

Adjusting buffer size on Windows

On Windows, the buffer size is adjusted in the web app Device tab (page 12). See “Host Buffer Size” and “Host Safety Offset” on page 28.

Lower latency versus higher CPU overhead

Buffer size has a large impact on the following:

- Monitoring latency
- The load on your computer’s CPU
- Responsiveness of transport controls and effect knobs in AudioDesk, Digital Performer or other audio software.
- Real-time virtual instrument latency.

The buffer setting presents you with a trade-off between the processing power of your computer and the delay of live audio as it is being patched through your software. If you reduce the size, you reduce monitoring latency, but significantly increase the overall processing load on your computer, leaving less CPU bandwidth for things like real-time effects processing. On the other hand, if you increase the buffer size, you reduce the load on your computer, freeing up bandwidth for effects, mixing and other real-time operations.

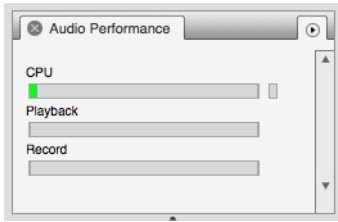

Figure 7-5: When adjusting the buffer size to reduce monitoring latency, watch the 'processor' meter in Digital Performer or AudioDesk's Performance Monitor. If you hear distortion, or if the Performance meter is peaking, try raising the buffer size.

If you are at a point in your recording project where you are not currently working with live, patched-thru material (e.g. you're not recording vocals), or if you have a way of externally processing inputs, choose a higher buffer size. Depending on your computer's CPU speed, you might find that settings in the middle work best (256 to 1024).

Transport responsiveness

Buffer size also impacts how quickly your audio software will respond when you begin playback, although not by amounts that are very noticeable. Lowering the buffer size will make your software respond faster; raising the buffer size will make it a little bit slower.

Effects processing and automated mixing

Reducing latency with the buffer size setting has another benefit: it lets you route live inputs through the real-time effects processing and mix automation of your audio software.

WORKING WITH THE ROUTING GRID

The Routing grid (Figure 7-6) gives you a lot of control over the audio routing to and from your computer, as explained in the following sections.

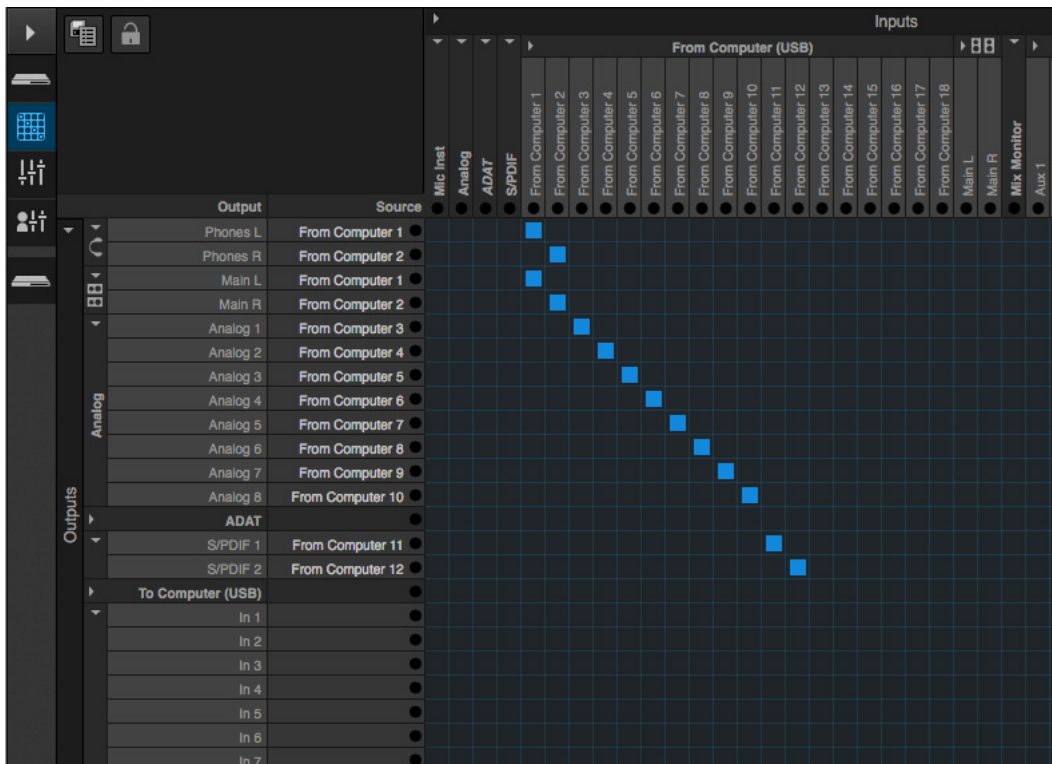

Figure 7-6: An example of routing computer channels (from host audio software) to the analog outputs on a UltraLite-mk4, plus the S/PDIF digital output. Computer channels 1-2 are being split to two pairs of outputs: Phones L-R and Main L-R. The ADAT bank is not being used.

Enabling and disabling input/output banks

In the web app Routing tab (page 15), you can enable any input and output banks on your MOTU device that you wish to make available to your host audio software. You can disable banks you are not using to simplify operation.

Specifying the number of computer channels

In the web app Routing tab *Enable Inputs/Outputs* sections (Figure 7-6), you can specify the number of computer channels for streaming audio to and from your host audio software. You might want enough channels to cover the following:

- Physical inputs you want to record on your computer.
- The physical outputs you want to send audio playback to.
- Any audio streams going to and from the on-board mixer in your MOTU device.

If you aren't sure how many channels you'll need, visit the Routing tab, as explained below.

Making inputs and outputs available to your host software

In the web app, use the Routing tab (page 15) to map inputs and outputs to computer channels, as demonstrated in Figure 7-6 and Figure 7-7.

Configuration presets

The presets menu (item #7 in the Devices tab on page 12) provides many useful presets for various host routing scenarios. These presets are a convenient shortcut for the routing grid setups discussed in the next few sections.

Naming computer input and output channels

Click on any computer input or output name in the routing grid (Figure 7-6) to change its name.

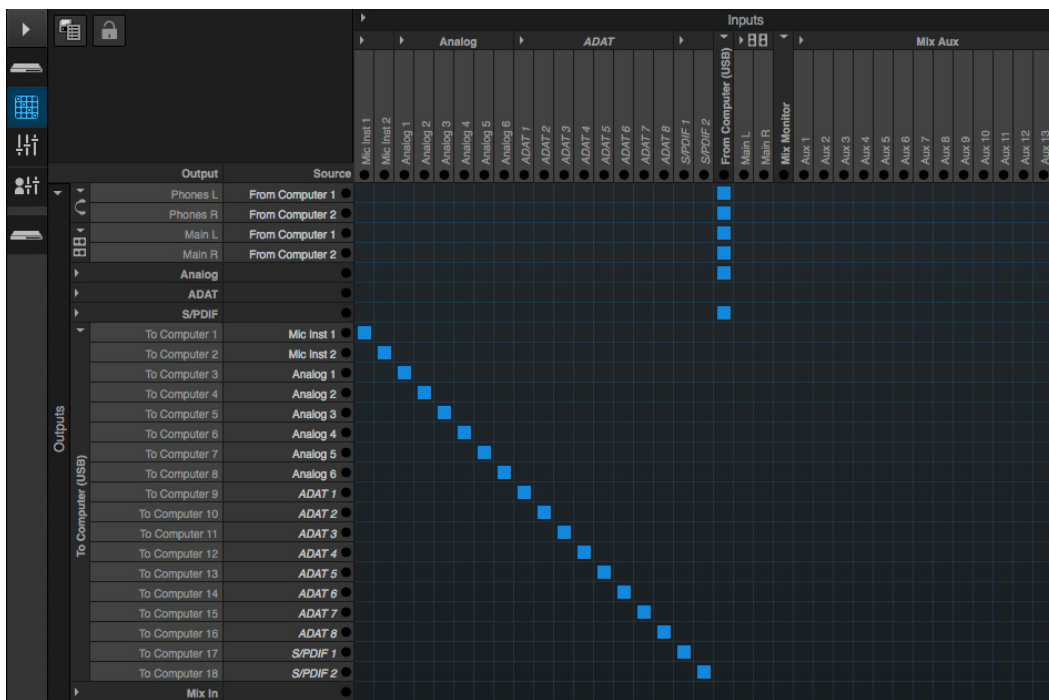

Figure 7-7: An example of routing all eighteen physical inputs on the UltraLite-mk4 to computer channels (for host audio software).

Streaming computer audio to and from the on-board mixer

In Figure 7-6, you'll see mixer inputs across the top of the grid (Main, Monitor, Aux, etc.) These are output buses from the UltraLite-mk4's on-board mixer. To route one of these mix buses to your host computer software, click the grid at the intersection of the mix column and desired computer channel row. Now, the mix bus output will be routed to the computer via the channel you selected.

Conversely, you can stream audio from the computer into the mixer. Channels coming from the computer are represented across the top of the routing grid as inputs. To route a computer channel to the mixer, click the grid at the intersection of the computer channel column and the desired mix input row. Now, that computer channel will be routed to the mixer input.

Mirroring computer channels to multiple outputs

Figure 7-6 shows an example of mirroring one stereo audio stream from host audio software to several outputs. In the example, computer channels 1-2 are being sent to Phones L-R and Main L-R. To route a source to multiple destinations, click multiple boxes in its column, (see *From Computer* channels 1-2 in Figure 7-6).

Combining multiple sources to one output

To merge (mix) any channels in the grid (computer streams or otherwise), route them to mixer inputs and then use the on-board mixer ("Mixing tab" on page 16).

Routing grid tutorials

For further info about using the routing grid, including many useful tips and techniques, visit:

www.motu.com/techsupport/technotes/avbrouting

and

www.motu.com/avb

WORKING WITH ON-BOARD MIXING AND EFFECTS

the UltraLite-mk4 provides powerful mixing, EQ, compression and reverb, which can operate hand-in-hand with your host's mixing environment. For example, the UltraLite-mk4 can serve as a monitor mixer, routing channels to musicians, or it can serve as an integrated extension of your host's mixing environment. You can even save a particular mixing configuration as a preset for future recall. For details, see "Mixing tab" on page 16.

LTC-TO-MTC CONVERSION

When connected to a Mac, your MOTU interface can convert SMPTE time code (LTC) to MIDI Time Code (MTC), allowing any MTC-compatible host audio software to resolve to MTC.

LTC-to-MTC conversion can be done even when the Clock Mode setting for the MOTU interface is set to *Internal* (or any other setting). Note that the Clock Mode setting does NOT have to be set to *LTC*. In other words, the interface can convert LTC to MTC even when it is not resolving its audio engine to the incoming time code. This allows your DAW host software to resolve to time code with fast lockup response.

To set up LTC-to-MTC conversion:

- 6 Set the interface Clock Mode to *Internal* (or any other desired setting).
- 7 Set the other LTC settings as needed, as discussed in "Syncing to SMPTE time code (LTC)" on page 35, including the *Computer Channel for LTC-to-MTC Conversion* setting.
- 8 If you would like MIDI Time Code to continue to be generated, even after LTC stops being received, check *Enable Jam Sync* (Figure 4-5 on page 36). Otherwise, leave it unchecked.

9 Follow the directions for MTC (SMPTE) sync in your DAW software.

Your MOTU interface driver automatically communicates with OS X, creating a device in the computer's Audio MIDI Setup configuration that reports its time code port to any MTC-compatible host software. If your host software requires that you specify the port, you should see your MOTU interface SMPTE Sync port as an available option in the list. In Digital Performer, this is the *Sync to port* menu in the Receive Sync settings (Setup menu), which is set to *Any* by default (so it should just work). Here's a summary for a few popular DAW hosts:

Host software	Sync settings
Digital Performer and AudioDesk	Settings menu > Receive Sync > Sync to port menu
Pro Tools	Setup > Peripherals > Synchronization
Logic	File > Project Settings > Synchronization > General
Live	Preferences > MIDI Sync
Cubase	Transport > Project Synchronization Setup

CHAPTER 8 Mixer Effects

OVERVIEW

This chapter provides further information about the effects processors available in the DSP mixer in the UltraLite-mk4. For basic mixer operation, see:

- Mixing tab 16
- Aux Mixing tab 17
- Mixer input channel strips 18
- Main Mix and Monitor channel strips 19
- Aux bus channel strips 20
- Group and Reverb channel strips 21

Powerful DSP-driven mixing and effects

The mixer is driven by a powerful DSP that delivers 32-bit floating point precision and plenty of processing bandwidth for no-latency effects, including parametric EQ, dynamics, and reverb. Effects can be applied when operating as an audio interface or as a stand-alone mixer without a computer. Input signals to the computer can be recorded wet and/or dry, or recorded dry while a real-time wet monitor mix is sent to musicians. Effects include:

- High Pass Filter 53
A conventional high pass filter
- Gate 54
A standard gate with threshold/attack/release controls
- Four-band parametric EQ 54
Multi-band parametric EQ modeled after British analog consoles
- Compressor 55
A standard compressor with threshold/ratio/attack/release/gain controls

- Leveler 57

The Leveler™, an accurate model of the legendary LA-2A optical compressor, which provides vintage, musical automatic gain control

- Reverb 58

Classic reverb with tail lengths up to 60 seconds

Advantages over host-based mixing and processing

The hardware mixer in the UltraLite-mk4 provides several major advantages over mixing and processing in your host audio software:

- No buffer latency. The DSP-mixer provides the same near-zero latency throughput performance as a conventional digital mixer. Effects processing doesn't impact your computer's CPU.
- DSP mixing and routing can be maintained independently of individual software applications or projects.
- DSP-driven mixing can function without the computer, allowing the UltraLite-mk4 to operate as a portable, stand-alone mixer with effects.
- ☛ Effects are disabled when operating at 4x sample rates (176.4 or 192 kHz).

HIGH PASS FILTER

All input channel strips provide a 12 dB per octave high pass filter. High Pass filters are often used to remove unwanted mic rumble, for example.

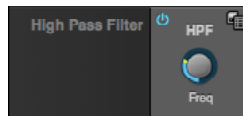

Figure 8-1: The High Pass Filter.

GATE

All input channel strips provide a Gate module.



Figure 8-2: The Gate module.

The gate silences the signal when the input signal's level drops below the *Threshold*.

The rate at which the gate responds, (opens to let signal through) is determined by the *Attack* parameter. With a short Attack time, the gate will open as soon as the signal crosses the Threshold; with longer Attack times, the gate will gradually open, much like a fade-in.

When the input level falls back below the Threshold, the time it takes for the gate to close (how quickly the signal is attenuated), is determined by the *Release* parameter. Short Release times will close the gate quickly, abruptly attenuating your signal, versus longer release times, which will gradually attenuate your signal, like a natural fade-out.

FOUR-BAND PARAMETRIC EQ

All mixer channel strips, (except for the Monitor bus), provide modeled, four-band parametric EQ.

Vintage EQ

Inspired by legendary British large console EQs, the *EQ section* (Figure 8-3) models the sound of the most sought-after classic equalizers. Four bands of center frequency parametric EQ filtering are provided, each with a bandwidth control. The High and Low bands include a shelf filtering option. With 32-bit floating point precision, the vintage EQ has been carefully crafted and meticulously engineered to produce musical results in a wide variety of applications.

Enabling EQ

Each band has an *enable/disable* button (Figure 8-3), allowing you to enable as few or as many bands as needed for the channel strip.

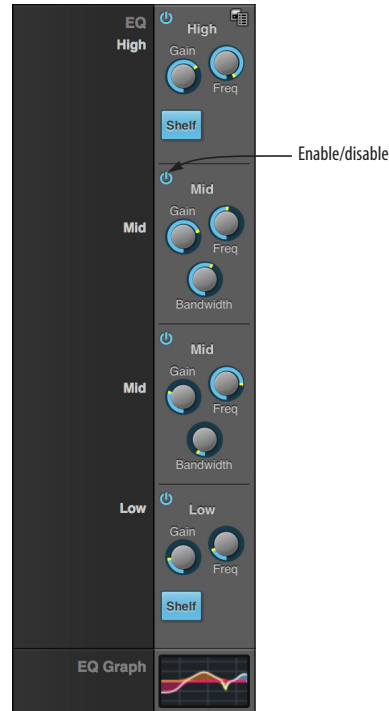

Figure 8-3: The Four-band parametric EQ module.

EQ filter controls

The EQ filters have three controls:

Control	unit	range
Gain	dB	-20.00 to +20.00
Frequency	Hertz	20 to 20,000
Bandwidth	Octaves	0.01 to 3.00

Double-click a knob to return to its default position.

EQ filter characteristics

EQ is one of the most widely used processing tools and can be applied to many different situations, from minor corrective tasks to creative tone

sculpting. The four-band EQ has been designed to be flexible enough to cover a broad range of applications. By adjusting Gain and Bandwidth together, you can emulate the smooth and musical character of classic analog EQ circuits, in which the Gain/Bandwidth dependency was dictated by the actual circuit design and electrical components used.

Low and high shelf filters

The Low and High bands offer a shelf option that is similar to those found in most conventional parametric EQs.

EQ graph

The EQ graph below the EQ section (Figure 8-3) provides a thumbnail visual indication of the current EQ settings for the input channel. It is for visual reference only and cannot be edited directly. However, you can click it to open the full-size EQ graph in a separate window (Figure 8-4), which is fully editable.

COMPRESSOR

All mixer input channel strips provide a compressor module.



Figure 8-5: The Compressor module.

The *Compressor* (Figure 8-5) lowers the level of the input when amplitude of the signal is above the *Threshold*. The amount of attenuation is determined by the *Ratio* and the input level. For example, if the input is 6 dB above the *Threshold* and the *Ratio* is 3:1, the compressor will attenuate

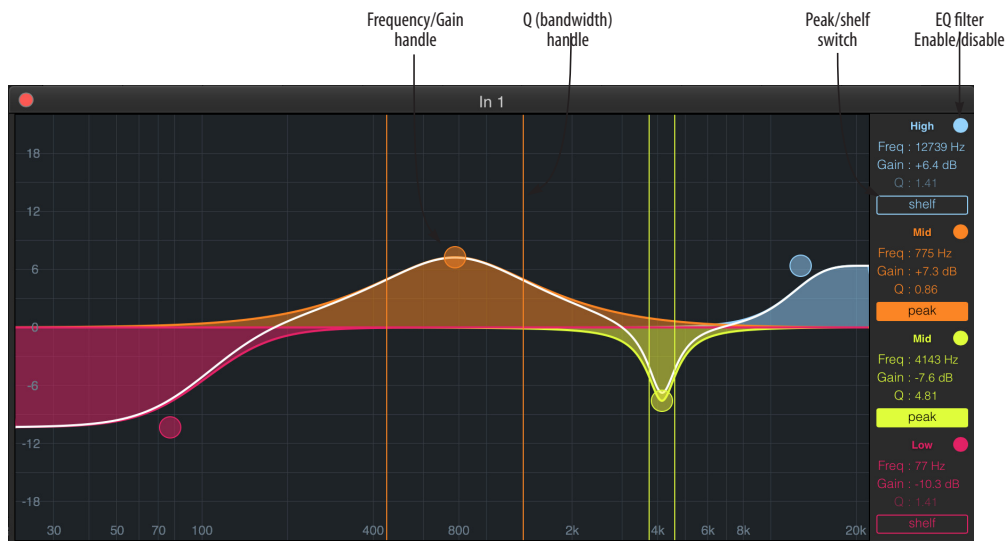

Figure 8-4: The full-size EQ graph.

the signal to 2 dB above the Threshold. When the input level goes above the threshold, the attenuation is added gradually to reduce distortion. The rate at which the attenuation is added is determined by the *Attack* parameter. Likewise, when the input level falls below the Threshold, the attenuation is removed gradually. The rate at which the attenuation is removed is determined by the *Release* parameter. Long Release times may cause the audio to drop out briefly when a soft passage follows a loud passage. Short Release times may cause the attenuation to “pump”, a term used to describe the sound of the compressor when the average input level quickly fluctuates above and below the Threshold. These types of issues can be addressed by adjusting the compressor’s parameters, or applying the Leveler instead. *Gain* adjusts the overall output level of the compressor, post processing. The Level meter (Figure 8-5) shows the level of the input signal entering the compressor. It shows either the Peak envelope or the RMS level, if enabled.

Gain reduction meter

The Gain reduction meter (Figure 8-5) displays the current amount of attenuation applied by the compressor, before the makeup gain stage.

RMS mode

By default, the compressor operates in Peak mode, which uses signal peaks to determine the input level. In RMS mode, the compressor measures the input signal’s loudness, using the root-mean-square computational method. When RMS is disabled, RMS mode will let brief peaks through because the detector sidechain is only looking at the average signal level. By contrast, peak mode will catch those brief peaks. Peak mode is generally used for drums, percussion and other source material with strong transients, while RMS mode is mostly used for everything else.

The level meter shows either the peak level or the RMS level, depending on the mode.

Compressor graph

The Compressor graph below the Compressor section (Figure 8-5) provides a thumbnail visual indication of the current compressor settings for the input channel. It is for visual reference only and cannot be edited directly. However, you can click it to open the full-size Compressor graph in a separate window (Figure 8-6), which provides graphic editing of the Ratio and Threshold controls.

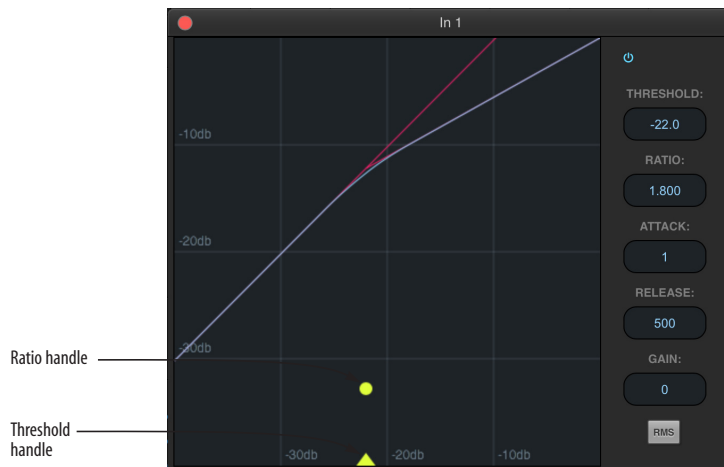

Figure 8-6: The full-size Compressor graph.

LEVELER

The Leveler™ (Figure 8-7) provides an accurate model of the legendary Teletronix™ LA-2A® optical compressor, known for its unique and highly sought-after Automatic Gain Control (AGC) characteristics.



Figure 8-7: The Leveler module.

The Leveler is available on the Main Mix bus and all Group busses, including the Reverb bus.

A model of an optical compressor

An optical leveling amplifier works by shining a light on a photoresistor. The intensity of the light source is proportional to the audio signal, and the resistance of the photoresistor is in turn inversely proportional to the intensity of the light. Photoresistors respond quite quickly to increases in light intensity, yet return to their dark resistance very slowly. Thus, incorporation of the photoresistor into an attenuator followed by an amplifier which provides make-up gain produces a signal which maintains a constant overall loudness.

Automatic gain control using light

The AGC circuit of the LA-2A uses a vintage optocoupler known by its model number T4. The T4 contains an electroluminescent-panel (ELP) and photoresistor mounted so that the emission of the panel modulates the resistance. An ELP consists of a thin layer of phosphorescent material sandwiched between two insulated electrodes to form a capacitor. Making one of the electrodes transparent allows the light to escape. These

devices are essentially glow-in-the-dark paint on a piece of foil covered by metalized glass or plastic, and are the same devices used in low-power night lights. Unfortunately, these devices need high voltages to operate, and are best driven by tube circuits which can supply voltage swings of several hundred volts.

Response characteristics

Once the light has faded away, the photoresistor then decays back to its dark state. The shape of the decay curve varies depending on how bright the light was, and how long the light lasted. A general rule of thumb is that the louder the program, the slower the release. Typically, the release can take up to and over one minute. One thing to keep in mind when using these types of devices is that the typical concepts of compression ratio, attack, release, and threshold do not apply. The light intensity is determined by the highly non-linear interactions of the input signal, AGC circuit, and ELP, and thus exhibit a strong program dependence that is impossible to describe without the mind-numbing mathematics of statistical mechanics. The actual results, however, can be almost mystical: even when you feed the same material (a loop perhaps) through the Leveler twice, you'll often see a new response the second time through a loop, complete with unique attack times, release times and compression ratios. Furthermore, two different input signals with the same RMS levels may be leveled in a drastically different manner.

It is precisely this self-adjusting behavior that makes optical compressors the tool of choice for smoothing out vocals, bass guitar and full-program mixes without destroying perceived dynamics.

Enabling or disabling the Leveler

The Leveler models the LA-2A so closely, it also models the time it takes for an actual LA-2A to “warm up” after it is turned on. Therefore, when you enable the Leveler, give it a moment to “settle” before you begin processing signals with it.

Gain Reduction

Gain Reduction (Figure 8-7) sets the strength of the signal sent to the AGC model.

Makeup Gain

Makeup gain (Figure 8-7) amplifies the output signal to make up for gain reduction.

Limit button

The *Limit* button (Figure 8-7) models the original LA-2A Limit/Compress mode switch. The effect is very subtle, with the Limit option behaving only slightly more like a limiter than a compressor. The switch increases the level of the input to the AGC model and runs the attenuator at a slightly lower level. The Leveler then responds more strongly to transients, but otherwise still behaves like a leveling amplifier.

REVERB

Use the enable/disable button (Figure 8-8) to turn the reverb processor on or off. Since reverb uses considerable DSP resources, it is best to leave it off when you are not using it.



Figure 8-8: The Reverb processor.

Routing inputs and groups to the reverb processor

The reverb processor is a single, independent unit that provides stereo reverb. You can route any input channel or Group bus to the Reverb processor with the Reverb send on its channel strip. All incoming signals to the reverb processor are merged and processed together. The resulting stereo output from the reverb can then be merged into the Main Mix bus with the Main send on the Reverb channel strip (item #7 on page 21).

Reverb Time

Reverb time (Figure 8-8) determines the length of decay, or *tail*, of the reverb. The knob’s range is from 100 milliseconds to 60 seconds.

Predelay

Predelay is the amount of time before the acoustic energy from the source returns to the listener, after reflecting off the surfaces of the listening space. The very first reflections helps you perceive information about the listening space, (size, distance, surface type, etc.). In large rooms, it takes a while (on the order of milliseconds) before the first reflections return to the listener. Predelay is useful for adding clarity, as it delays these reflections, before the onset of full reverberation. For example, with pre-delay added to vocals, the reflections won’t start until after the initial sound of a word has been sung.

Spread

Spread controls stereo imaging. A position of 12 o’clock produces essentially a mono image. Turning the control all the way to the left completely swaps the stereo image.

High and Mid frequency bands

The High and Mid frequency bands let you independently control the reverb time for separate frequency bands, relative to the low frequency reverb time. The *High* setting represents the bottom frequency of the High band; the *Mid*

setting represents the bottom frequency of the Mid band. The *Ratio* determines the length for each band specified in a percentage of the low frequency reverb time.

DSP USAGE

The DSP Usage meter (item #30 on page 18) shows how much of the available DSP processing power is currently being used by the mixer for the mix and for effects processing. If there aren't enough DSP resources for all effects to be enabled on a channel, effects are disabled for that channel and all subsequent channels.

☛ Unlike other effects, HPF and EQ on a stereo channel requires approximately twice the DSP resources as on a mono channel.

CHAPTER 9 MOTU Audio Tools

The MOTU Audio Tools application provides advanced audio analysis tools, which can be applied to a left channel input, right channel input, or both.

- Installation..... 61
- Device menu..... 61
- Analysis menu 62
- Left/right input 62
- FFT and Spectrogram display..... 63
- Oscilloscope 65
- X-Y Plot 70
- Phase Analysis..... 73

INSTALLATION

MOTU Audio Tools is a standard software application installed on your Mac or PC when you run the MOTU Pro Audio installer or setup app. It can be found in the Applications folder (Mac) or Start menu under MOTU (Windows).

DEVICE MENU

If you are working with more than one MOTU audio interface, the *Device* menu (Figure 9-1) displays all interfaces that are currently connected to your host computer. Choose the device you wish to work with.

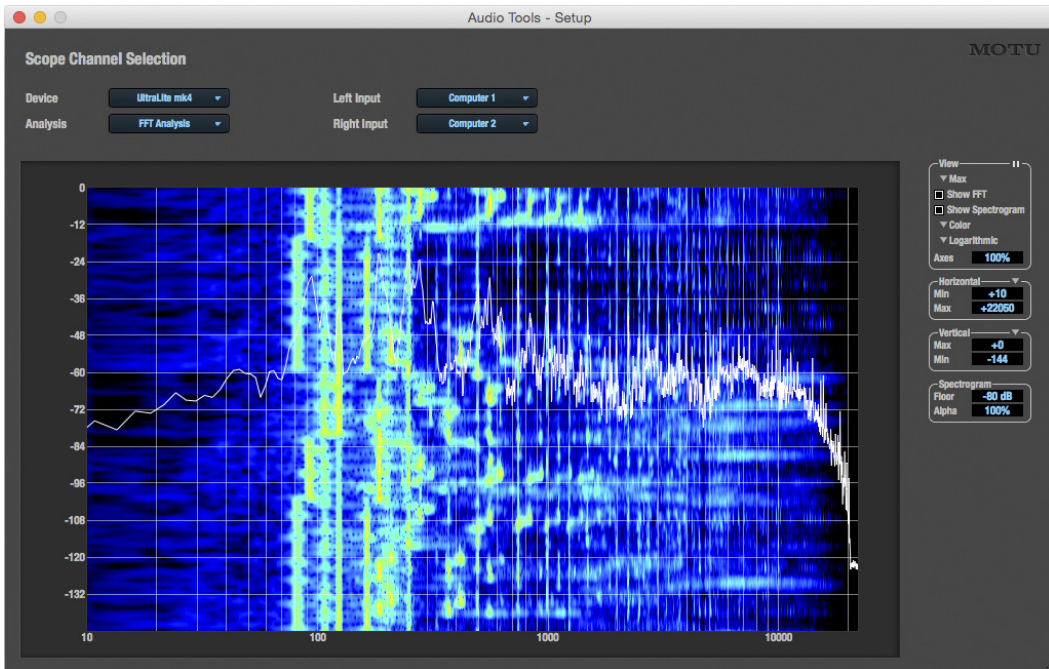

Figure 9-1: The MOTU Audio Tools window with the FFT and Spectrogram Analysis.

ANALYSIS MENU

Choose the desired form of audio analysis from the *Analysis* menu (Figure 9-1). For details on each analysis pane, see the following sections of this guide.

LEFT/RIGHT INPUT

Choose the desired channel(s) you wish to scope from the *Left Input* and *Right Input* menus (Figure 9-1). These menus display the *To Computer* channels configured in the MOTU Pro Audio Control web app. The number of channels shown is controlled by the *From device to computer* setting in the Device tab. For example, if 18 channels are specified, you'll see 18 channels in the *Left/Right*

Input menus. Use the Routing tab to map desired audio sources (listed across the top of the grid) to the *To Computer* audio channels, as demonstrated with the UltraLite-mk4 interface in Figure 9-2.

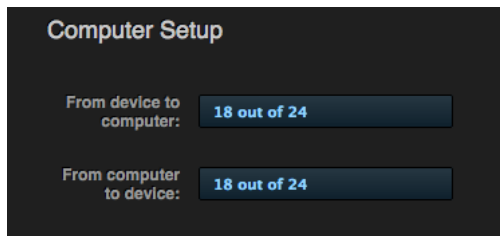

Figure 9-3: The 'From device to computer' setting determines how many channels you see in the Left Input and Right Input menus.

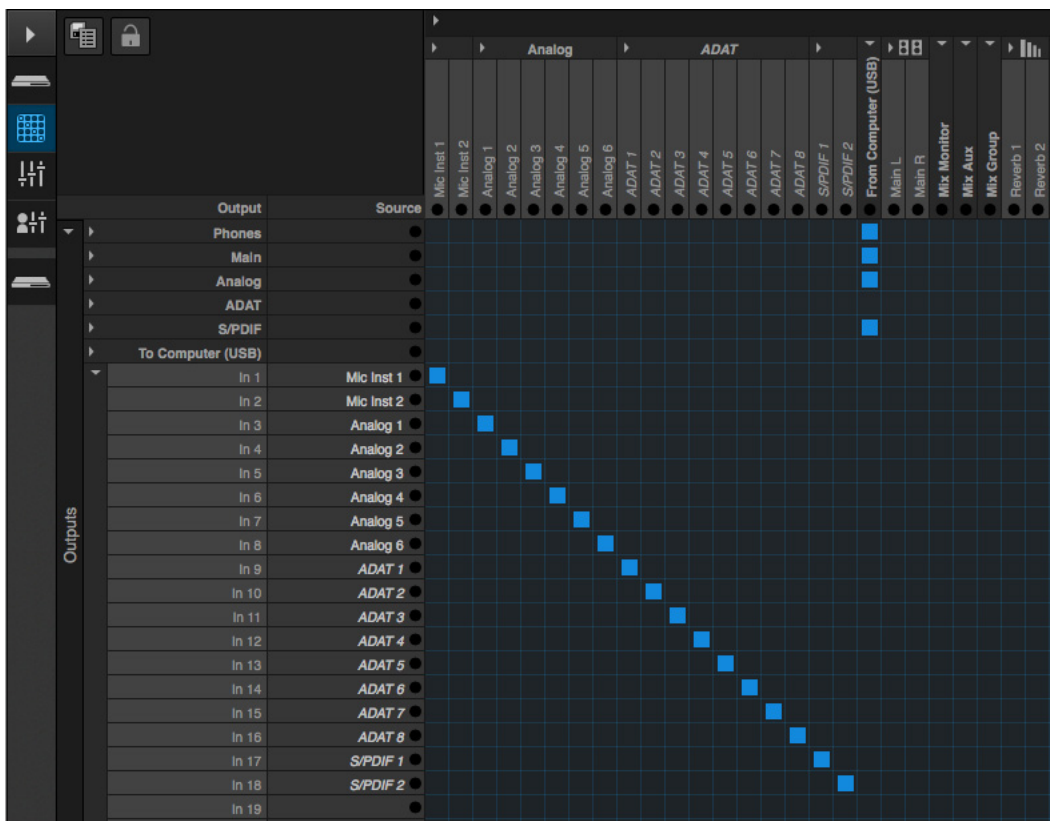

Figure 9-2: An example of routing audio sources (listed across the top of the routing grid) on an UltraLite-mk4 interface to computer channels (for routing to the MOTU Audio Tools application).

FFT AND SPECTROGRAM DISPLAY

The FFT analysis pane displays a real-time Fast Fourier Transform (FFT) frequency measurement and spectrogram “waterfall”, as shown in Figure 9-4.

Spectrogram

The spectrogram scrolls from top to bottom, where the top edge of the display represents what you are hearing “now”. Color represents amplitude along the left/right frequency spectrum. The amplitude color scale runs from black (silence) to red (full scale) as follows:

Silence —————> Full scale
 Black —> Blue —> Green —> Yellow —> Orange —> Red

Figure 9-5: Spectrogram color-to-amplitude spectrum.

View controls

You can show and hide the FFT display and spectrogram as desired using the *View* controls (Figure 9-6).

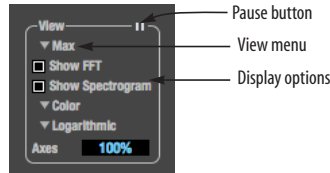

Figure 9-6: FFT view controls.

View menu

This menu provides various options for displaying the two input channels.

View menu setting	What it does
Left	Displays the left channel only.
Right	Displays the right channel only.
Split Screen H	Shows both channels side by side, with the screen split horizontally.
Split Screen V	Shows both channels side by side, with the screen split vertically.
Shared	Displays both FFTs (left is green and right is red), and the spectrogram waterfall shows the maximum level of either the left or right channel (whichever is greater).
Max	The FFT and spectrogram shows the maximum level of either the left or right channel.
Subtract L - R	Subtracts the right channel from the left channel and displays the results.

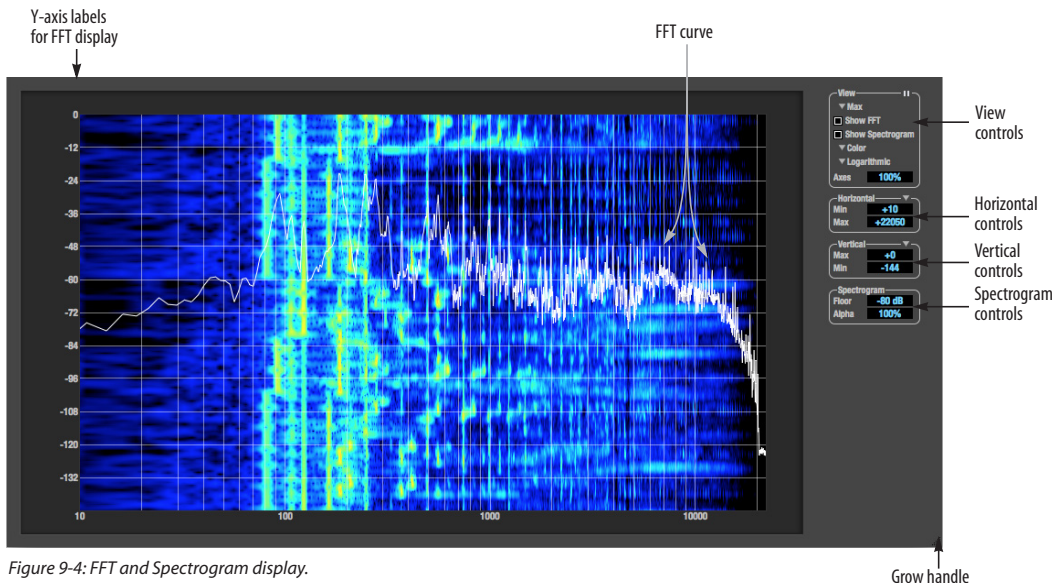

Figure 9-4: FFT and Spectrogram display.

Logarithmic or Linear X-Axis Scale

The x-axis defaults to a logarithmic scale, but it can be changed to a linear scale if desired. In the View controls (Figure 9-6), click *Logarithmic* to access the x-axis scale options menu. With a linear scale selected, frequency is constant, but the width of each octave along the x-axis is different. With a logarithmic scale selected, octaves are displayed with a constant width, but frequency is displayed logarithmically within each octave.

Axes display

The *Axes* control (Figure 9-6) sets the opacity of the grid displayed in the graph, from 100% (fully visible) down to 0% (fully hidden).

Pausing the display

The *Pause* button in the upper right corner of the View section (Figure 9-6) allows you to freeze the display at any time. To resume, click the button again.

Horizontal controls (frequency axis)

The *Horizontal* controls (Figure 9-7) configure the value range of the x-axis (frequency). Click and drag the values up or down to set them, or double-click to return to the default value.



Figure 9-7: The Horizontal controls.

There are two modes for the controls: *Zoom/Offset* and *Min/Max*. To change the mode, use the Horizontal control menu (Figure 9-7).

In *Zoom/Offset* mode, *Zoom* sets the display zoom from 1x to 100x, where the number represents the zoom factor relative to the entire frequency range. For example, when the horizontal zoom value is 1x, the entire frequency range from 10 to 24000 Hertz is displayed; when the horizontal zoom value is 2x,

one half of the entire frequency range is displayed. *Pos* determines which frequency is displayed at the center of the graph.

In *Min/Max* mode, *Min* and *Max* set the lowest and highest displayed frequencies (in Hertz).

Vertical controls (amplitude axis)

The *Vertical* controls (Figure 9-8) operate similarly to the Horizontal controls, except that they configure the y-axis (amplitude).



Figure 9-8: The Vertical controls.

In *Zoom/Offset* mode, *Zoom* sets the display zoom from 1x to 100x, and *Pos* sets the center amplitude of the graph. In *Min/Max* mode, *Min* and *Max* set the smallest and largest displayed amplitude.

Spectrogram controls

The *Floor* control (Figure 9-9) sets the amplitude threshold for the spectrogram display, from -144 dB up to 0 dB.

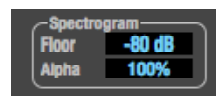

Figure 9-9: The Spectrogram controls.

The *Alpha* control (Figure 9-9) sets the opacity of the spectrogram information displayed in the graph, from 100% (fully visible) to 0% (hidden).

OSCILLOSCOPE

The Oscilloscope (Figure 9-10) graphs the amplitude of an audio signal over time.

Amplitude is displayed on the y-axis and time is displayed on the x-axis. A thick white vertical line marks where time equals zero; a thick white horizontal line marks where amplitude equals zero (Figure 9-10, below).

Level meters are displayed to the right of the graph. One or two meters are shown, depending on the current view mode (see “View controls”).

View controls

The View controls (Figure 9-11) provide several options for the oscilloscope display.

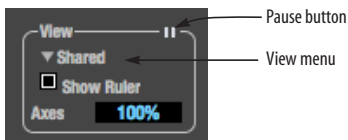

Figure 9-11: View controls.

View menu

The View menu (Figure 9-11) lets you choose how to display the audio channel(s) being displayed.

View menu setting What it displays

Left	Left channel only
Right	Right channel only
Split screen	Left channel on top; right channel on the bottom
Shared	Left and right on top of each other; left is green, right is red
Add	Left and right channels' amplitudes are added together
Subtract L-R	The right channel's amplitude is subtracted from the left channel's amplitude

Display options

The Axes control (Figure 9-11) sets the opacity of the grid displayed in the graph, from 100% (fully visible) down to 0% (fully hidden). The Show Ruler option toggles the measurement items (see “Measurement information” on page 68).

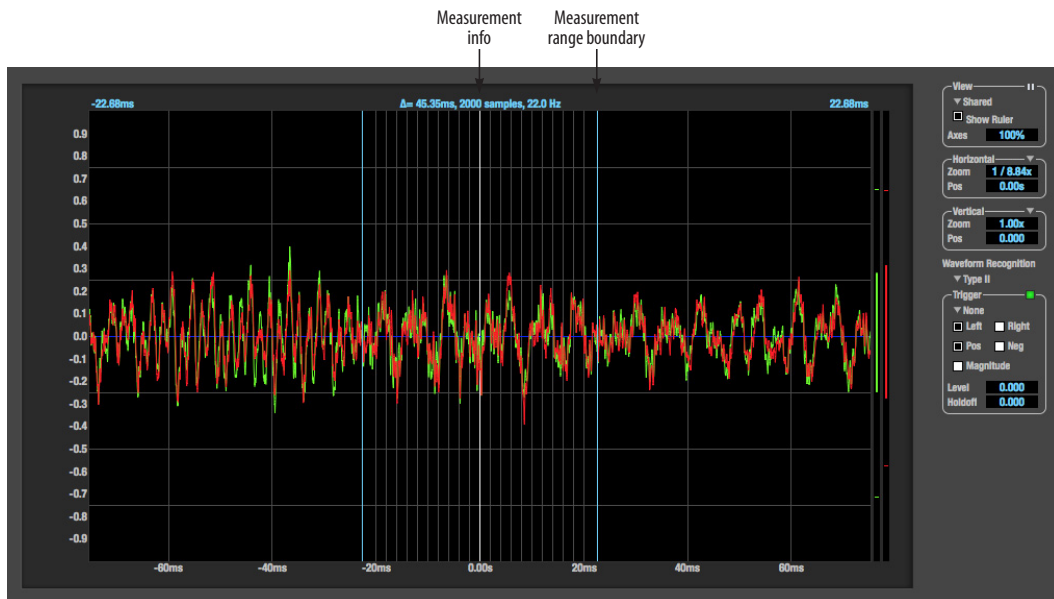

Figure 9-10: Oscilloscope.

Pausing the display

The Pause button in the upper right corner of the View section (Figure 9-11) allows you to freeze the display at any time. To resume, click the button again. The level meters will remain active while the display is paused.

Horizontal controls (time axis)

The *Horizontal* controls (Figure 9-12) configure the value range of the x-axis (time). Click and drag the values up or down to set them, or double-click to return to the default value.

There are two modes for the controls: *Zoom/Offset* and *Min/Max*. To change the mode, use the Horizontal control menu (Figure 9-12).



Figure 9-12: Horizontal controls.

In *Zoom/Offset* mode, *Zoom* sets the display zoom from 1/1000x to 10x, where the number represents the number of pixels per sample. For example, when the horizontal zoom value is 10x, 10 samples are displayed in 100 pixels; when the horizontal zoom value is 1/10x, 100 samples are displayed in 10 pixels. *Pos* moves the line marking time equals zero left or right.

In *Min/Max* mode, *Min* and *Max* set the earliest and most recent displayed time.

Time Units

The *Time Units* sub-menu (Figure 9-12) provides the option to view the X axis in Seconds or Samples.

Vertical controls (amplitude axis)

The *Vertical* controls (Figure 9-10) operate similarly to the Horizontal controls, except that they configure the y-axis (amplitude).

In *Zoom/Offset* mode, *Zoom* sets the display zoom from 1/2 to 100x, and *Pos* moves the line marking amplitude equals zero line up or down.

In *Min/Max* mode, *Min* and *Max* set the smallest and largest displayed amplitude.

Waveform Recognition

The Waveform Recognition option (Figure 9-10) searches through new audio data looking for a waveform which most resembles that which was previously displayed. The region where this takes place is a small window around the line marking time equals zero, denoted by the extra vertical graph lines surrounding it. There are two kinds of waveform recognition available: Type I and Type II.

Type I recognition provides the most stable display of the waveform. It is the most resistant to change. Louder transients, such as those produced by a snare drum, are not displayed inside of the waveform window. Type I is best for observing the shape of a signal produced by a synthesizer or observing the tone of a guitar through a chain of pedals.

Type II recognition is less resistant to change. It will include loud transients within the waveform recognition window. Type II is better for observing percussive music where the beat itself is to be centered within the waveform window.

Trigger

When the *Trigger* (Figure 9-13) is not enabled (the Trigger menu is set to *None*), the graph updates based on time: after every *n* samples of the monitored audio signal, the most recent samples are displayed. When the Trigger is enabled (set to any mode other than *None*), the graph updates in response to specific conditions in the signal. The Trigger section defines that criteria and how the graph will display the events that match.

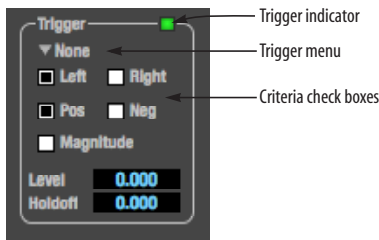

Figure 9-13: Trigger settings.

Criteria

The criteria checkboxes (Figure 9-13) determine the conditions that the trigger is looking for and where it will look for them.

The *Left* checkbox causes the condition to be looked for in the left channel of the signal; likewise, the *Right* checkbox looks for the condition in the right channel. One or both of these can be enabled simultaneously. If neither is enabled, the criteria will not be found because the trigger is not looking at any audio signal.

The *Pos* and *Neg* checkboxes determine the slope of the event. When the *Pos* checkbox is enabled, the trigger will look for an event where amplitude is increasing; likewise, enabling the *Neg* checkbox tells the trigger to look for an event where amplitude is decreasing. One or both of these can be enabled simultaneously. If neither is enabled, the criteria will not be found because the trigger is not looking for any particular kind of event.

The *Level* setting defines the amplitude threshold that the trigger is looking for. The Level is indicated on the graph by a blue horizontal line (or two blue horizontal lines, if *Magnitude* is enabled). Events which cross this threshold using the enabled slope(s) in the enabled channel(s) will activate the trigger. The response of the trigger is set by the Trigger mode (see “Trigger modes”, below).

Enabling the *Magnitude* checkbox tells the trigger to look for both positive and negative Level values, regardless of whether the Level value is positive or negative. For example, if Level is set to +0.500 and *Magnitude* is enabled, the trigger will look for both +0.500 and -0.500. You will see a second blue line appear in the display when *Magnitude* is enabled to denote the second value.

Holdoff

Holdoff defines a time interval during which the oscilloscope does not trigger. The most recent trace will be displayed during that period. When the period is over, the trigger is “re-armed”, i.e. it will begin looking for the criteria again.

Click and drag this value up or down to set it, or double-click to return to the default value.

Trigger modes

The Trigger menu (Figure 9-13) provides four modes:

Trigger mode	What it does
None	The Trigger is not active; this is the default mode. The incoming audio signal will be displayed continuously as audio is received.
Auto	The display is always updating, but when the condition is met, the trigger event will be displayed centered around the line marking time equals zero.
Normal	The display updates only when the condition is met; the last trace will be displayed until the next matching event is found.
Single Sweep	Similar to Normal mode, but the last trace will be displayed until you manually arm the trigger by clicking the Trigger indicator (Figure 9-13 on page 67) or by pressing the spacebar.

Trigger indicator

The Trigger indicator (Figure 9-13) displays the state of the trigger, and also provides a way to manually interact with it. The Trigger indicator always displays one of three colors:

Color	Status
Green	When the current Trigger criteria has been met (including when the Trigger mode is <i>None</i>).
Yellow	When the Trigger is armed, but has not yet found an event which matches its criteria. Yellow can also indicate that the graph has been manually paused using the Pause button in the View section (see “Pausing the display” on page 66).
Red	When the Trigger is being held off, either because the Trigger mode is set to Single Sweep or the Holdoff time is not set to zero.

You can also click on the Trigger indicator to force certain actions, depending on the Trigger mode. In Auto and Normal modes, clicking on the Trigger indicator causes the display to run freely; you may click & hold to force this to occur for as long as you'd like. In Single Sweep mode, clicking on the Trigger indicator re-arms the trigger. When the Trigger mode is *None*, clicking on the Trigger indicator has no effect.

Measurement information

You can view detailed information about a particular time range by using the measurement bars (Figure 9-10).

To adjust the left and right edges of the measurement area, click and drag the blue bars in the graph (Figure 9-10), or click and drag the blue numbers in the upper left or right corners. To reset them to the default value, double-click the numbers.

Information about the measured area is displayed at the center of the top ruler: the duration (in seconds and samples), the approximate frequency,

and the scientific note name. If the measured area is long enough, the approximate beats per minute (bpm) is displayed.

Ideas for using the Oscilloscope

The Oscilloscope can be used in many useful ways during the routine operation of your recording studio. Here are just a few examples.

Analyzing and comparing harmonic content

The oscilloscope lets you “see” the nature of the harmonic profile in any audio material. You can also view two signals side by side (in stereo mode) to compare their profiles and, if necessary, make adjustments to the source of each signal and view your changes in real time.

Viewing transients such as drum hits

If you loop a snare hit or other similar transient audio clip and feed it through the oscilloscope, you can more or less “freeze” the transient waveform in the oscilloscope frame. This can be useful, for example, for viewing the results of real-time compression that you are applying with an effects plug-in. For example, when you are compressing a snare hit, as you make adjustment the compressor, you can see the transient waveform change the next time the Oscilloscope triggers. For compression, this can be particularly useful for balancing the effect of the attack on the transient, relative to the decay portion of the waveform. Conversely, you can see the effect of the threshold setting directly on the decay portion, relative to the attack. In effect, you can see as well as hear the results of your compression adjustments.

To view a transient waveform in the Oscilloscope display, turn off Waveform Recognition and use the *Normal* Trigger mode. Adjust the level high enough to encompass the vertical amplitude of most of the transient. If the transient pulse sweeps across the screen, try raising the Holdoff level. Once the transient is settled in the display and fairly stable, you may need to adjust the horizontal position to

center it in the display. You can also pause the display at any time and adjust the horizontal bounds to locate a transient.

Clip detection

You can use the Oscilloscope to detect clipping in a digital audio signal. To do so, enable all criteria (Figure 9-13), choose *Single Sweep* from the trigger menu (Figure 9-13), set the level to 0.999 and click the trigger indicator (Figure 9-13) to arm it (yellow). As soon as the signal clips, the trigger indicator will turn red, and the display will show the offending clip at the line marking time equals zero.

Viewing timing pulses

If you have two audio signals with recognizable, timed pulses in them, and you wish to compare their timing with respect to each other, you can use Split Screen or Shared view to visually compare the timing of the two signals. You can zoom in to the sample level for sample accurate viewing.

Building synthesizer patches

If you are building a synth patch on a synthesizer (or forming similar highly periodic audio material), you can run the audio signal through the Oscilloscope as you adjust its sound to check in real time for undesirable (and possibly inaudible) characteristics, which are easily seen in the Oscilloscope display. A good example is DC offset. If a signal develops DC offset, the apparent vertical center of its overall waveform will drift above or below the line marking amplitude equals zero. Try setting Waveform Recognition to *Type I* and setting Trigger to *None*.

Another example is waveform polarity. If you are combining several raw waveforms, polarity is a critical, yet not always obvious, factor in determining the resulting sound. You can use the Oscilloscope to easily view and compare polarities

to see if they are inverted from one another or not. The *Add* and *Subtract L - R* View menu settings are particularly useful here.

You can also use the Oscilloscope to help you apply waveform modulation and keep it “in bounds”. For example, you could easily see if pulse width modulation is collapsing in on itself to choke the sound, an effect that is readily seen in the Oscilloscope display but not necessarily easy to determine by ear when using multiple modulation sources.

Guitarists can also visually observe the effects of their pedals and processing, while playing. With the Trigger mode set to *None* and Waveform Recognition set to *Type I*, the waveform will be tracked automatically.

When applying filters and filter resonance, the visual effect on the waveform can be invaluable in reinforcing what you are hearing as you make adjustments.

X-Y PLOT

The *X-Y Plot* window (Figure 9-14) graphs the amplitude of a stereo audio signal on a two-dimensional grid.

For each unit of time (i.e., each sample), the amplitude of the left channel is displayed on the x-axis and the amplitude of the right channel is displayed on the y-axis. A thick white vertical line marks where left channel amplitude equals zero; a thick white horizontal line marks where right channel amplitude equals zero (Figure 9-14). There are also thick white diagonal lines for $y = x$ and $y = -x$.

Metering

Level meters are displayed above and to the right of the graph for the left (green) and right (red) channels, respectively. An additional *Correlation meter* (blue) is displayed on the right. This meter displays the correlation between the two channels.

The higher the meter, the higher the correlation between the two channels. Below are a few examples:

Situation	Meter level	X-Y Plot graph	Mathematical relationship
Perfect correlation	+1	Diagonal line going from lower left to upper right:	$y = x$
Zero correlation	0	No discernible pattern	None
Perfectly out of phase	-1	Diagonal line going from upper left to lower right:	$y = -x$

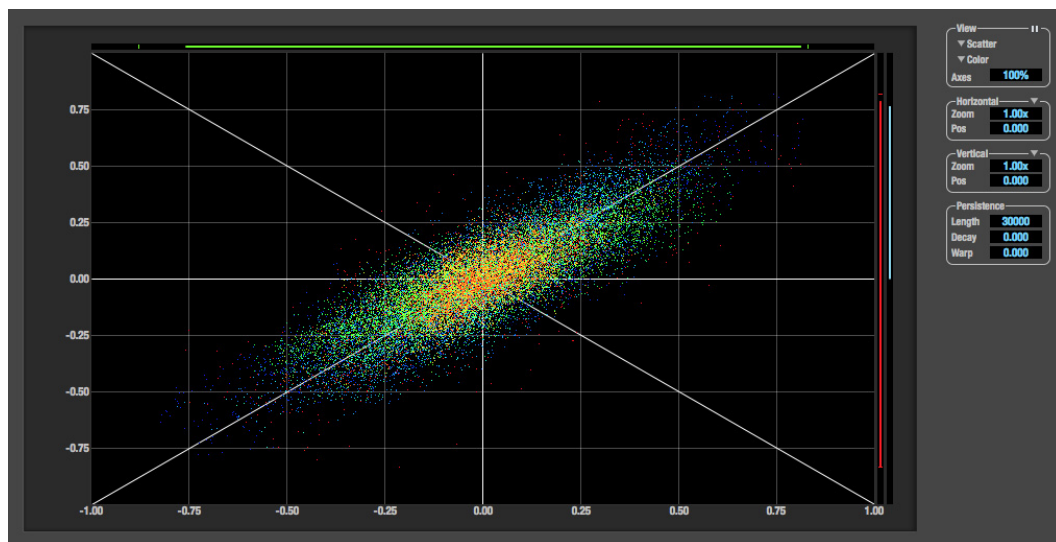

Figure 9-14: X-Y Plot.

View controls

The View controls (Figure 9-15) provide several options for the X-Y Plot display.

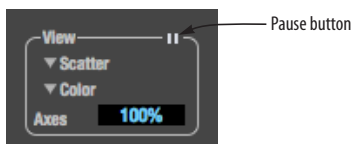

Figure 9-15: View controls.

Pausing the display

The Pause button in the upper right corner of the View section (Figure 9-15) allows you to freeze the display at any time. To resume, click the button again. The level meters will remain active while the display is paused.

Line/Scatter

Choose either *Line* or *Scatter* from the menu in the View section (Figure 9-15) to plot each point (sample) as either a single pixel or as a continuous line that connects each plot point to the next, as shown below in Figure 9-16.

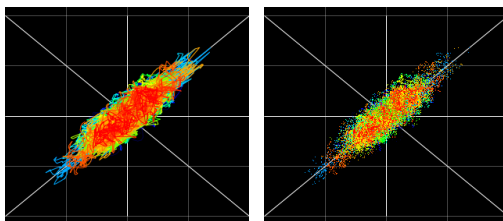

Figure 9-16: The same X-Y Plot displayed in Line versus Scatter mode.

Line mode is significantly more CPU intensive than Scatter. You can reduce Line mode CPU overhead on the X-Y Plot by reducing the Length parameter (described below).

Color/Grayscale

In *Color* mode (Figure 9-15) the most recently displayed audio data is shown in red, which fades to yellow, green and then finally blue, before disappearing. In Grayscale mode, data is first

shown in white and then fades to gray. To adjust the scale of this color/brightness change, see “Decay” on page 72.

Axes

The *Axes* control (Figure 9-15) sets the opacity of the grid displayed in the graph, from 100% (fully visible) down to 0% (fully hidden).

Horizontal and vertical controls

The *Horizontal* and *Vertical* controls (Figure 9-17) configure the value range of the x-axis (left channel amplitude), and y-axis (right channel amplitude), respectively. Click and drag the values up or down to set them, or double-click to return to the default value.

There are two modes for the controls: *Zoom/Offset* and *Min/Max*. To change the mode, use the menu shown in Figure 9-17.

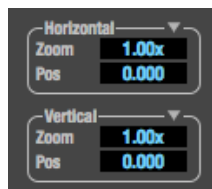

Figure 9-17: Setting the Horizontal or Vertical control modes.

In *Zoom/Offset* mode, *Zoom* scales the axis. *Pos* moves the lines marking $x = 0$ left and right, or $y = 0$ up and down.

In *Min/Max* mode, *Min* and *Max* let you scale the grid by moving the -1.0 and $+1.0$ points along the axis. *Min/Max* mode lets you control the graph boundaries directly.

Persistence

The *Persistence* controls (Figure 9-18) affect the appearance of data from when it is first displayed until it disappears from the grid.

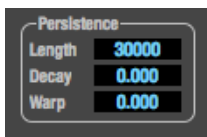

Figure 9-18: The Persistence controls.

Length

Length (Figure 9-18) sets the number of recent samples to show on the plot. For example, when Length is set to 10,000, the 10,000 most recent samples are shown.

Decay

The brightness (in Grayscale mode) or hue (in Color mode) of each sample on the plot is determined by a linear scale, with the most recent sample displayed at the maximum value and the oldest sample displayed at the minimum value.

Decay (Figure 9-18 on page 72) determines the brightness or hue of the minimum value. When Decay is zero, the oldest sample is black. When Decay is +1.000, the oldest sample is fully opaque (in Grayscale mode) or red (in Color mode).

Warp

Warp (Figure 9-18) determines the position of data points after they are first drawn. When warp is zero, data points remain in the same position.

When warp is positive, they contract towards the origin (center of the grid). When warp is negative, they expand away from the origin. The further the warp value is from zero, the greater the effect.

Using the X-Y Plot

The X-Y Plot helps you “see” the width of the stereo field of a mix (Figure 9-19). It also helps you determine if a mix has issues with polarity, as follows:

Activity on the X-Y Plot	What it indicates
Signal activity occurs mostly along the $x = y$ axis (lower left to upper right) and the Correlation meter reading is high	Left and right channels are predominantly in polarity (the stereo field is relatively narrow)
Signal activity occurs mostly along the $y = -x$ axis (upper left to lower right) and the Correlation meter reading is low (near -1)	Left and right channels are predominantly out of polarity (not in phase)
Signal activity occurs in a seemingly random fashion throughout the grid	No phase relationship exists (i.e. it is probably a wide stereo field)

If a stereo signal is out of phase, it is not mono compatible because it can cancel itself out, either partially or nearly completely, when collapsed to mono.

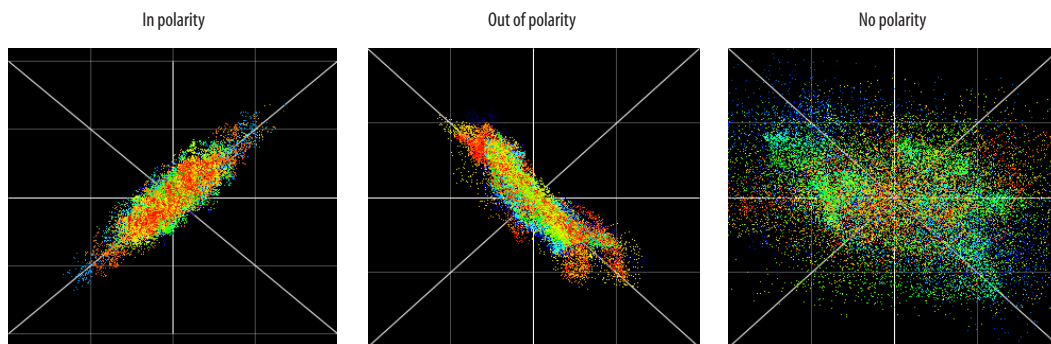

Figure 9-19: Checking polarity in a stereo signal with the X-Y Plot.

PHASE ANALYSIS

The *Phase Analysis* window (Figure 9-20) graphs frequency versus phase difference versus amplitude of a stereo signal on either rectangular or polar coordinates.

In rectangular coordinates, the vertical axis represents frequency, and the horizontal axis represents the phase of the left channel minus the phase of the right channel (measured in radians).

In polar coordinates, the radius represents frequency and the angle (theta) from the +y vertical axis represents the phase difference of left channel minus the right channel.

Correlation Meter

The blue *Correlation Meter* to the right of the display shows the correlation between the two channels. The higher the meter, the higher the correlation between the two channels.

View controls

The View controls (Figure 9-21) provide several options for the Phase Analysis display.

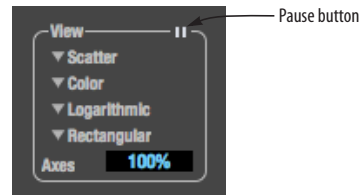

Figure 9-21: View controls.

Pausing the display

The Pause button in the upper right corner of the View section (Figure 9-21) allows you to freeze the display at any time. To resume, click the button again. The correlation meter will remain active while the display is paused.

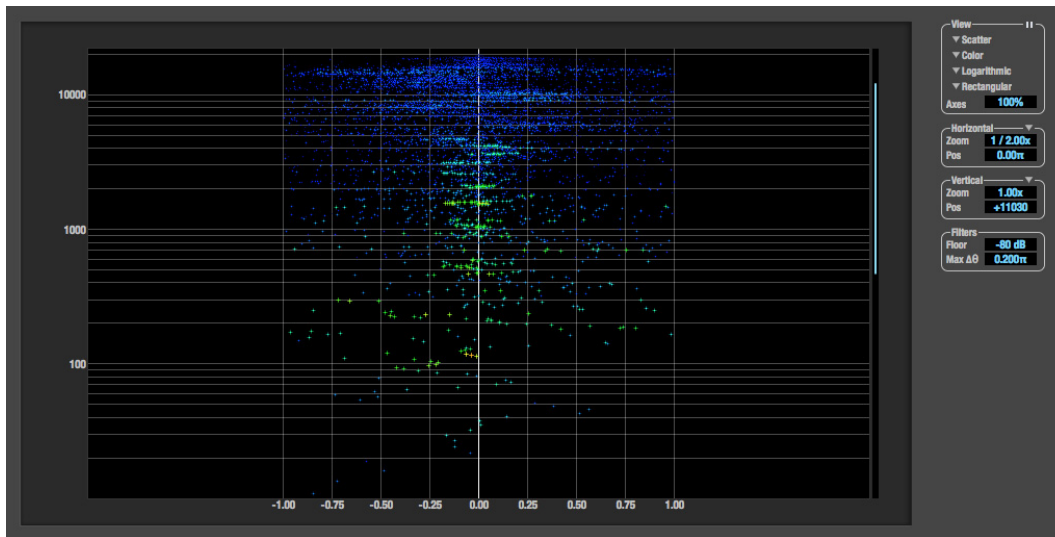

Figure 9-20: Phase Analysis.

Line/Scatter

Choose either *Line* or *Scatter* from the menu in the View section (Figure 9-21) to plot each data point as either a single pixel or as a continuous line that connects each frequency data point to the next, as shown below in Figure 9-16.

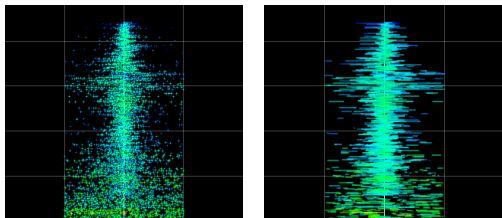

Figure 9-22: The same Phase Analysis displayed in Line versus Scatter mode.

Line mode is significantly more CPU intensive than Scatter. You can reduce Line mode CPU overhead for the Phase Analysis display by increasing the Floor filter and reducing the Max Delta Theta filters (see “Filters” on page 75).

Color/Grayscale

In *Color* mode (Figure 9-21) signal amplitude is indicated by color as follows: red is loud and blue is soft. In grayscale mode, white is loud and gray is soft.

Linear/Logarithmic

Choose either *Linear* or *Logarithmic* from the menu in the View section (Figure 9-21) to change the scale of the frequency axis. In rectangular coordinates, the vertical axis represents frequency, and in polar coordinates, the radius from the center is frequency. With a linear scale, frequencies are spaced evenly; in a logarithmic scale, each octave is spaced evenly (frequencies are scaled logarithmically within each octave).

Linear is better for viewing high frequencies; logarithmic is better for viewing low frequencies.

Rectangular/Polar

Choose either *Rectangular* or *Polar* from the menu in the View section (Figure 9-21) to control how audio is plotted on the Phase Analysis grid.

Rectangular plots the audio on an X-Y grid, with frequency along the vertical axis and phase difference on the horizontal axis. *Polar* plots the data on a polar grid with zero Hertz at its center. The length of the radius (distance from the center) represents frequency, and the angle (theta) measured from the +y (vertical) axis represents the phase difference in degrees.

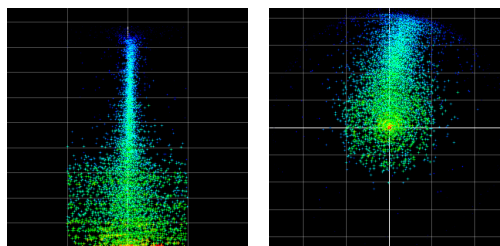

Figure 9-23: Rectangular versus Polar display (with a linear plot).

Above, Figure 9-23 shows Rectangular versus Polar display with a Linear plot. Below, Figure 9-24 shows the same displays (and the same data) with a Logarithmic plot:

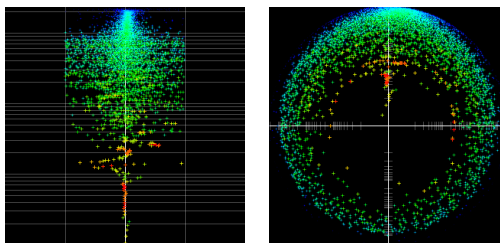

Figure 9-24: Rectangular versus Polar display with a logarithmic plot.

Axes

The *Axes* control (Figure 9-21) sets the opacity of the grid displayed in the graph, from 100% (fully visible) down to 0% (fully hidden).

Horizontal and vertical controls

The *Horizontal* and *Vertical* controls (Figure 9-25) let you scale each axis of the grid and offset its zero point. Click and drag the values up or down to set them, or double-click to return to the default value.

There are two modes for the controls: *Zoom/Offset* and *Min/Max*. To change the mode, use the menu shown in Figure 9-25.

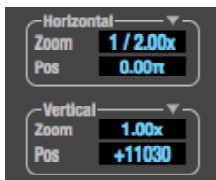

Figure 9-25: Setting the Horizontal or Vertical control modes.

In *Zoom/Offset* mode, *Zoom* scales the axis. *Pos* moves the zero line.

In *Min/Max* mode, *Min* and *Max* let you scale the grid by moving the end points along the axis. *Min/Max* mode lets you set the boundaries of the graph directly.

Filters

The *Filters* section (Figure 9-26) lets you control the density of the Phase Analysis display.



Figure 9-26: Filters.

Floor

Floor (Figure 9-26) determines the amplitude threshold for the display. When the amplitude of both channels drops below this threshold, the signal is not shown.

Max delta theta

Max delta theta (Figure 9-26) only affects Line view (see “Line/Scatter” on page 74) and sets the maximum difference in frequency between plot points in the line plot. For two adjacent frequencies, if the distance (phase difference) between the two frequencies is greater than the *Max delta theta*, then the line is not drawn.

Using the Phase Analysis

In the polar display (top row of Figure 9-27 on page 76), stereo material that is predominantly phase-aligned (correlated) appears along the vertical axis, as demonstrated in the first column (*Perfectly in phase*) in Figure 9-27. If the vertical line tilts left or right, this indicates general differences in phase; the more the tilt (delta theta), the more the phase difference. If the vertical line points downwards in the polar display, this indicates that the stereo image is predominantly out of polarity, as demonstrated by the fourth column (*Inverted*) in Figure 9-27. Delays appear as spirals in the polar display.

The rectangular display (bottom row of Figure 9-27) also shows a predominantly phase-aligned stereo image along the vertical axis, and tilt (or left-right offset) from the center vertical axis represents differences in phase. If a signal is predominantly out of polarity, it appears along the $\theta = -1.0$ or $\theta = +1.0$ lines in the rectangular display, as demonstrated in the fourth column (*Inverted*) in Figure 9-27 on page 76.

Using Phase Analysis for multiple mic placement

The polar display can be very useful when recording drums or another instrument with multiple microphones. The slight delays caused by the differences in distance to the source can often create a comb filtering (delay) effect between two mic signals, due to phase cancellation. These comb filter effects appear as spirals in the polar display. If you arrange the mics so that the null points (where the spiral pattern meets the negative y axis) are

outside the critical frequency range of the instrument being recorded, you can avoid phase problems among the mic signals.

Tuning PA systems

The Phase Analysis window can also be used to troubleshoot and tune PAs and sound reinforcement systems by placing microphones in strategic locations, comparing the two signals in the Phase Analysis grid and looking for phase issues at various locations.

Summing to mono

The Phase Analysis window is ideal for checking stereo audio that needs to be summed to mono. The Phase Analysis lets you see what frequencies will be canceled out when summed.

In the rectangular view, any lines in the signal that touch the +1.0 or -1.0 vertical lines in the grid will be canceled out at the frequency where they touch, when the signal is summed to mono.

In the polar view, any signal that falls on the negative y axis (below zero) will be canceled out when the signal is summed to mono.

Checking for phase issues in stereo tracks

You can use the Phase Analysis window to check the overall polarity of a stereo mix. Figure 9-28 is an example of a full stereo mix that has phase issues, as indicated by the majority of the signal's energy, which is predominantly skewed to the left side of the rectangular view (left) and spread along the -y axis in the polar view (right).

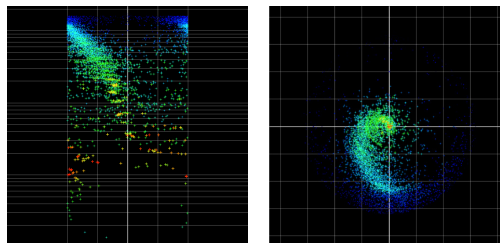

Figure 9-28: A stereo mix with phase issues.

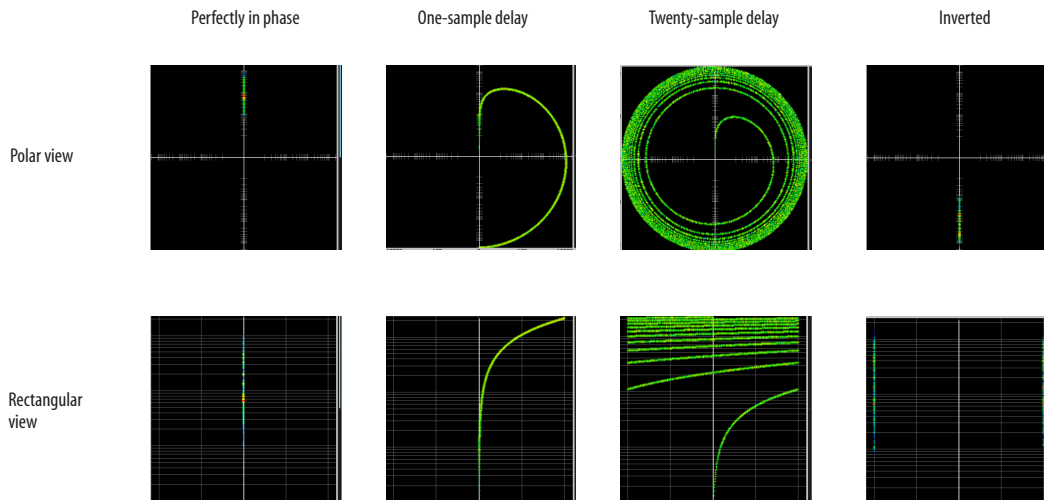

Figure 9-27: Two identical audio streams in the Phase Analysis.

Part 3

Appendices

APPENDIX A Troubleshooting

Some or all of my MOTU interface inputs and outputs are not available in my host audio software.

Make sure that the inputs and outputs are enabled in the Device tab (“Device tab” on page 12) and routed to and from the computer in the Routing tab (“Routing tab” on page 15). For details, see “Making inputs and outputs available to your host software” on page 50.

I have absolutely no audio input or output happening to or from my interface. Why?

Make sure that the unit has a stable sample rate (the sample rate will flash if the clock hasn’t settled yet). Try setting the unit’s clock source to *Internal* if you can’t sync to any external clock sources. Check that audio is working with Internal sync, and if so, then work on establishing a stable external clock.

I can't hear computer audio output through my MOTU interface.

In the Sound panel of System Preferences, the UltraLite-mk4 should be selected as the output device. Almost all applications will use just the first two output channels, so make sure that *From Computer 1* and *From Computer 2* are routed to the physical outputs that you are listening to in the Routing tab (e.g. Phones 1-2 or Analog 1-2).

How do I monitor live inputs?

Please refer to the documentation for the audio application that you are using. If your application does not support input monitoring, you will need to use the mixer in the UltraLite-mk4. Please see “Monitoring through the UltraLite-mk4” on page 46.

How do I control monitoring latency?

See “Reducing monitoring latency” on page 46.

The Routing tab (page 15) doesn't display some of the inputs or outputs on my interface.

The Routing tab only displays input and output banks that are enabled in the Device tab (page 12), so be sure any banks you wish to work with are enabled there. However, to conserve DSP resources and help consolidate screen-space in the other tabs, it is efficient practice to disable unused input or output banks (optical banks, for example, when only working with analog banks, or all output banks when only working with Phones).

I'm getting a "Could not enable this effect because DSP is overloaded" error. What should I do?

Disable other effects or reduce the number of mixer inputs to conserve DSP resources. If there are audio input and output banks on your interface that you are not using (such as the optical banks), disable them in the Device tab (page 12).

I accidentally deleted my factory presets. How do I restore them?

In the Device tab (page 12), click the *Restore Factory Presets* button to restore all factory presets.

How do I factory reset my device?

Push the SELECT knob/button to enter the main menu. Navigate to *Settings > Factory Default* and push the SELECT knob/button twice to reset.

Clicks and pops due to hard drive problems...

If you have checked your clock settings and you are still getting clicks and pops in your audio, you may have a drive related problem. Set your Clock Source to *Internal* and try recording just using the analog inputs and outputs on the UltraLite-mk4. If you encounter the same artifacts you may want try using another drive in your computer. Clicks and pops can also occur when the drive is severely fragmented or there are other drive-related issues.

Connecting or powering gear during operation...

It is not recommended that you connect/disconnect, or power on/off devices connected to the UltraLite-mk4 while recording or playing back audio. Doing so may cause a brief glitch in the audio.

CUSTOMER SUPPORT

We are happy to provide complimentary customer support to our registered users. If you haven't already done so, please take a moment to register online at MOTU.com, or fill out and mail the included registration card. Doing so entitles you to technical support and notices about new products and software updates.

TECHNICAL SUPPORT

If you are unable, with your dealer's help, to solve problems you encounter with your MOTU device, you may contact our technical support department in one of the following ways:

- Tech support hotline: (617) 576-3066 (Monday through Friday, 9 a.m. to 6 p.m. EST)
- Online support: www.motu.com/support

Please provide the following information to help us solve your problem as quickly as possible:

- The serial number of your MOTU device. This is printed on a label placed on the bottom of the rack unit. You must be able to supply this number to receive technical support.
- A brief explanation of the problem, including the exact sequence of actions which cause it, and the contents of any error messages which appear on the screen.
- The pages in the manual that refer to the features or operation of your MOTU Device or AudioDesk with which you are having trouble.
- The version of your computer's operating system.

We're not able to solve every problem immediately, but a quick call to us may yield a suggestion for a problem which you might otherwise spend hours trying to track down.

If you have features or ideas you would like to see implemented, we'd like to hear from you. Please write to the Development Team, MOTU Inc., 1280 Massachusetts Avenue, Cambridge, MA 02138, or use our online suggestion box at www.motu.com/suggestions.

APPENDIX B Audio Specifications

Line Out

Connector Type	1/4" Female, TRS	Balanced, tip hot
Output Impedance	100 ohm	Per leg
Dynamic Range	117 dB	A-weighted
THD+N	-101 dB	-1 dBFS, Unweighted, 1 kHz
Frequency Response	+0, -0.1 dB, 20 Hz/20 kHz	Ref. 1 kHz
Max Level Out	+20 dBu	
Trim Range	24 dB	-4 dBu to +20 dBu in 1 dB steps

Guitar In

Connector Type	Combo-style, TS female	Unbalanced
Impedance	1 megohm	
Dynamic Range	101 dB	A-weighted
THD+N	-94 dB	-1 dBFS, Unweighted
Frequency Response	+0.05, -0.1 dB	Ref. 1 kHz
Max Level In	-2 dBu with trim down, +10 dBu with trim up	0.615v to 2.45v
Trim Range	24 dB	-12 dBu to +12 dBu in 1 dB steps

Line In

Connector Type	1/4" Female, TRS	Balanced/unbalanced, Tip hot
Specification	Complies with EBU-R68 / SMPTE RP-155	
Impedance Load	10 k ohm	
Dynamic Range	110 dB	A-weighted
THD+N	-102 dB	-1 dBFS, Unweighted
Frequency Response	+0, -0.1 dB, 20 Hz/20 kHz	Ref. 1 kHz
Max Level In	+24 dBu	
Trim Range	118 dB	-96 dBu to +22 dBu in 1 dB steps

MIC In

Connector Type	Combo-style, XLR Male, Balanced	Pin 2 hot
Impedance Load	3k ohm, 4.5k with Pad	
Pad	-20 dB, Switchable per channel	
Phantom Power	+48v, Switchable per channel	DIN 45596 / IEC 61938-P48
EIN	-128 dBu, 20 – 20 kHz	Rs = 150 ohm
Dynamic Range	112 dB	A-weighted
THD+N	-104 dB	-1 dBFS, Unweighted, 1 kHz
Frequency Response	+0, -0.1 dB, 20 Hz/20 kHz	Ref. 1 kHz
Max Level In	+24 dBu	With pad
Trim Range	56 dB	0 to +56 dB in 1dB steps

Phones

Connector Type	1/4" Female, TRS Stereo	Tip Left, Ring Right
Dynamic Range	112 dB	A-Weighted
THD+N	-94 dB	Unweighted
Frequency Response	+0 -0.15 dB, 22 Hz/20 kHz	Ref. 1 kHz
Drive	Max. 80 mw	16/32/55 ohms
Trim Range	128 dB	0 to -127 dB (muted) in 1 dB steps

S/PDIF

Connector Type	RCA	
Termination	75 ohm I/O	
Lock Range	44.1k/48k, +/- 0.5%	1x, 2x
Input Voltage Range	0.2 Vpp/1Vpp	With termination
Output Drive	0.5.0 Vpp With termination	DC coupled
THD+N In (SRC)	-122 dB	Unweighted, With SRC
Specification	IEC-958/60968-3	

Power Supply

Connector Type	Concentric barrel, tip positive or negative	For external DC power supply (included)
Configuration	External power supply	
Power Input	12-18V DC, 10 watts	

APPENDIX C Mixer Schematics

MONO INPUT CHANNEL

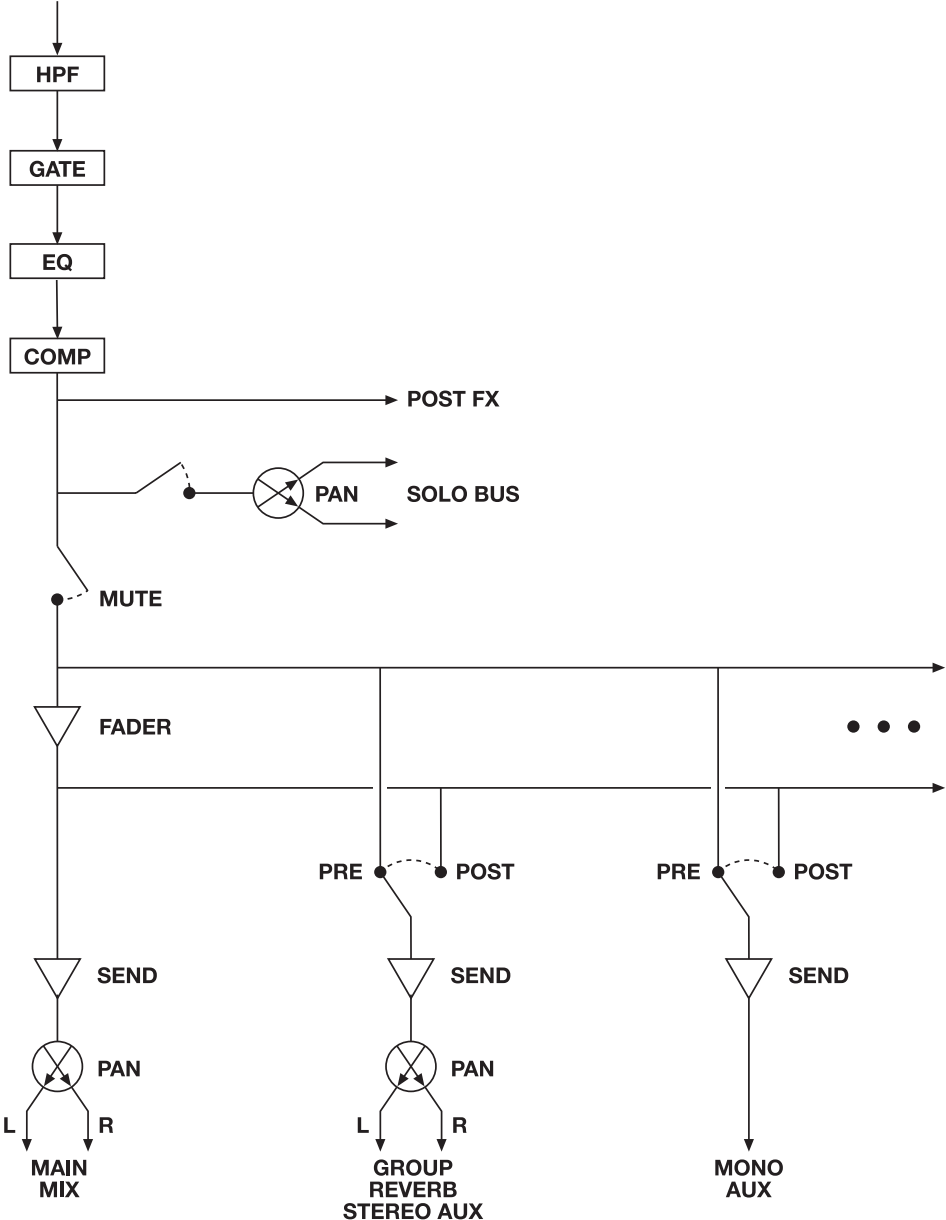

STEREO INPUT CHANNEL

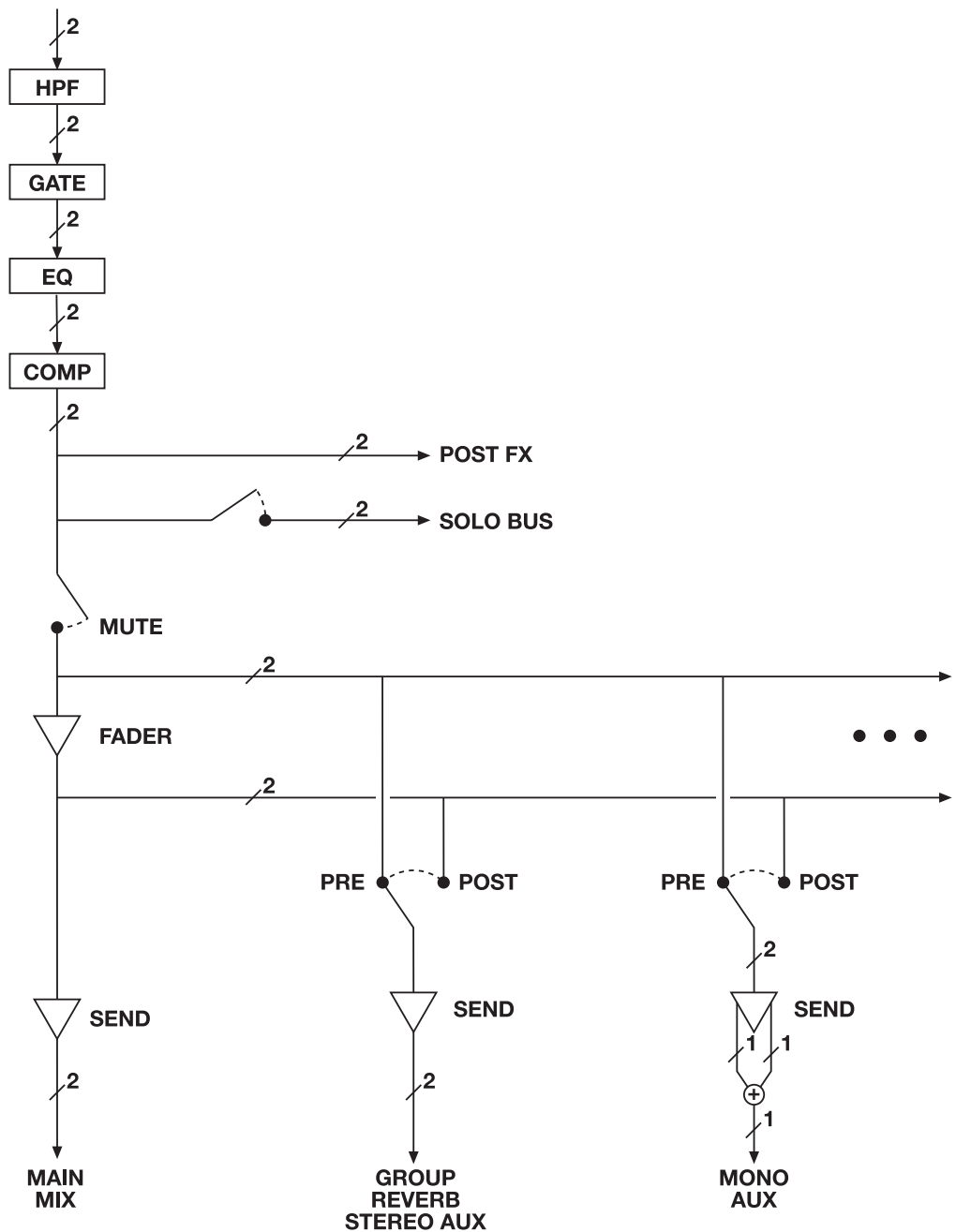

GROUP BUS

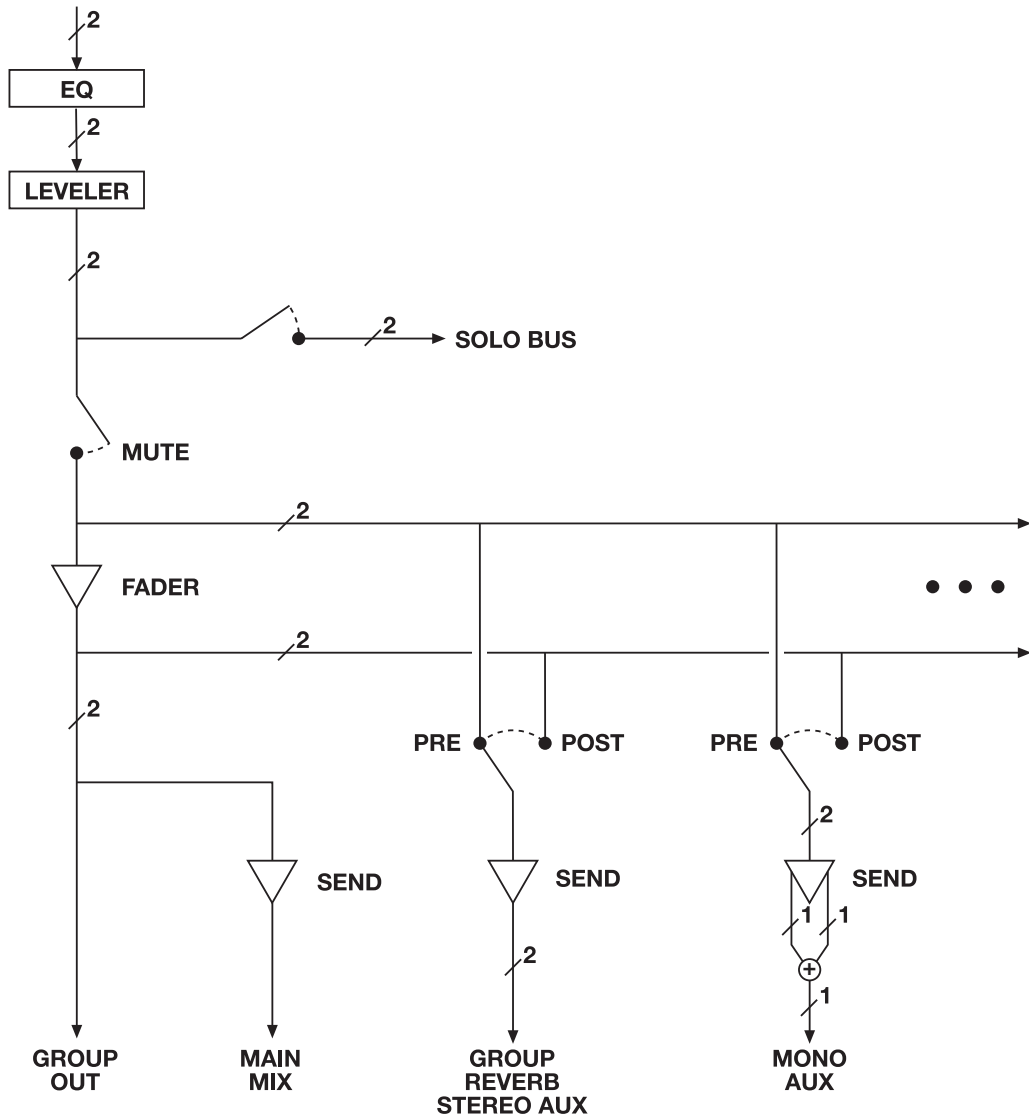

MONITOR BUS

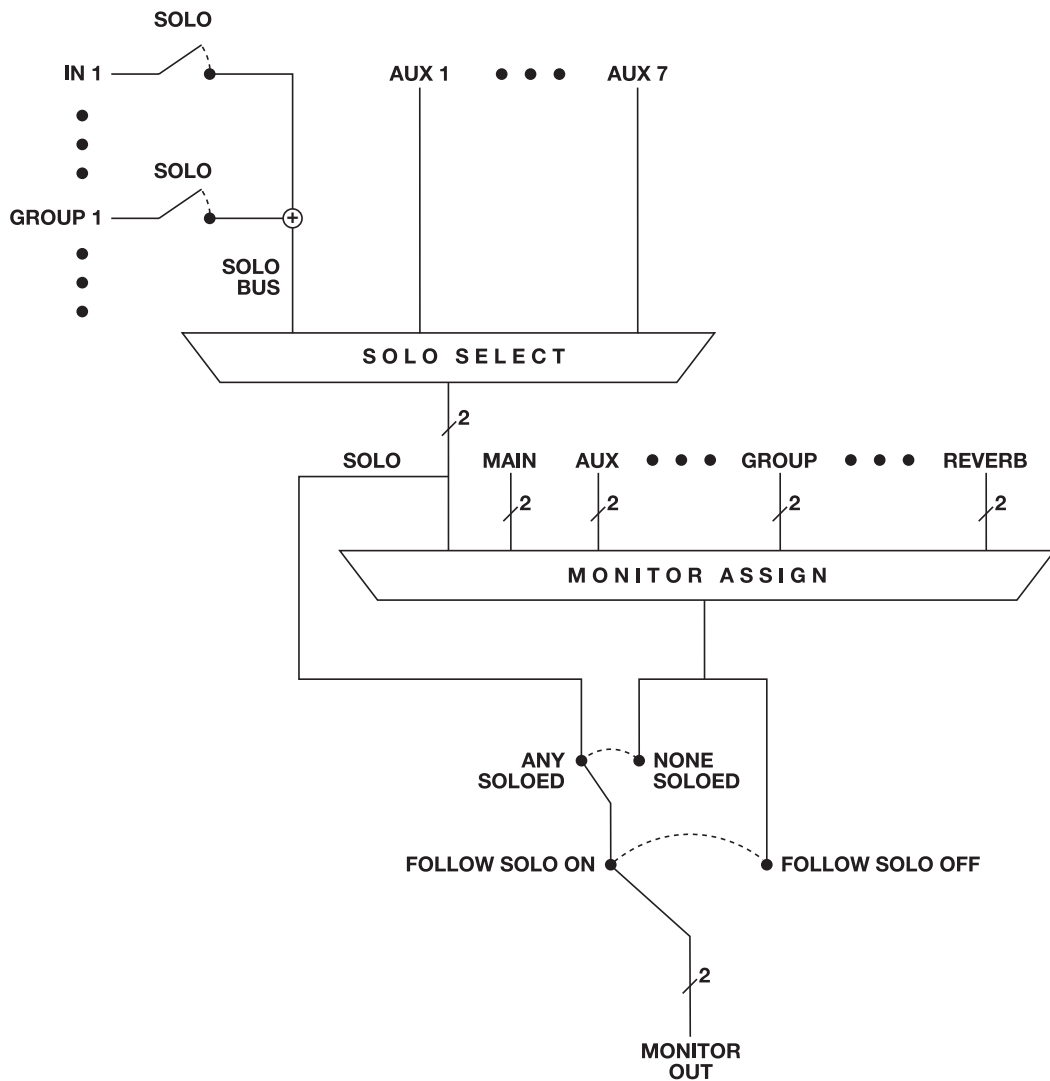

APPENDIX D **Updating Firmware**

MOTU periodically posts firmware updates for the UltraLite-mk4. These updates may include bug fixes, enhancements, and new features.

Updates are posted on MOTU's servers. If your computer has access to the internet, the MOTU Pro Audio Control app notifies you as soon as an update is made available. Otherwise, you can check motu.com/download periodically for the latest firmware update.

Updating with internet access

You are now ready to update:

- 1 Launch the MOTU Pro Audio Control web app on your computer, as usual.
- 2 Go to the Device tab.
- 3 In the *New Update Available* banner (Figure D-1), click *More Info*.
- 4 After reviewing the list of enhancements, click OK to start the update.
- 5 Follow the on-screen instructions.

Updating off-line, without internet access

If the UltraLite-mk4 (and the computer it is connected to) has no internet access, you can download a firmware update file from another computer that does have internet, and then use the file to update the UltraLite-mk4, as follows:

- 1 Download the firmware file.
- 2 Transfer the file to the computer connected to the UltraLite-mk4.
- 3 Launch the MOTU Pro Audio Control web app on the computer, as usual.
- 4 Go to the Device tab.
- 5 Scroll down to the bottom and click *Update from File*.
- 6 Locate the file on your hard drive and click OK to start the update.
- 7 Follow the on-screen instructions.

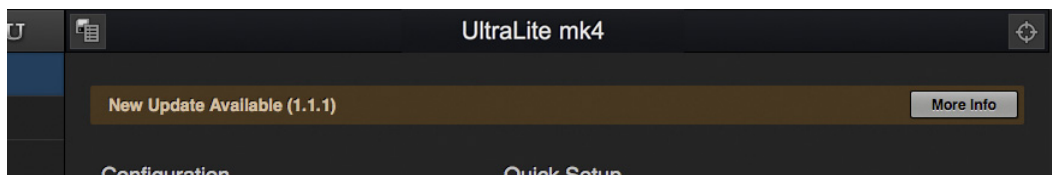
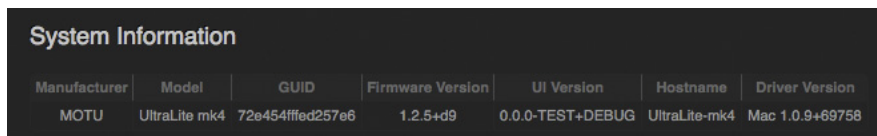

Figure D-1: The firmware update banner appears automatically at the top of the Device tab when your web host has internet access and MOTU posts an update.

Viewing the latest firmware version information

You can confirm the firmware version at the bottom of the Device tab (Figure D-2).



The screenshot shows a dark-themed table titled "System Information" with seven columns: Manufacturer, Model, GUID, Firmware Version, UI Version, Hostname, and Driver Version. The data row contains the following values: MOTU, UltraLite mk4, 72e454ffed257e6, 1.2.5+d9, 0.0.0-TEST+DEBUG, UltraLite-mk4, and Mac 1.0.9+69758.

Manufacturer	Model	GUID	Firmware Version	UI Version	Hostname	Driver Version
MOTU	UltraLite mk4	72e454ffed257e6	1.2.5+d9	0.0.0-TEST+DEBUG	UltraLite-mk4	Mac 1.0.9+69758

Figure D-2: The currently installed firmware version is displayed at the bottom of the Device tab.

APPENDIX E Auto-on Mode

From the factory, the UltraLite-mk4 must be manually powered on by pushing and holding the PHONES knob on the front panel (Figure 6-2 on page 43).

However, there may be situations where you want the unit to power on automatically as soon as power is introduced. For this situation, the UltraLite-mk4 circuit board provides a jumper to put the unit into *Auto-on* mode. In *Auto-on* mode, the UltraLite-mk4 powers on automatically, as soon as it receives power. No manual intervention is required.

CHANGING THE AUTO-ON JUMPER

To access the Auto-on jumper:

1 Switch off the UltraLite-mk4 and unplug the unit.

⚠ **WARNING:** be absolutely sure to unplug the unit before proceeding! Risk of electric shock and serious injury could result otherwise.



2 Carefully remove the two screws on the top of the unit.

3 Carefully remove the top cover of the unit.

4 Find the Auto-on jumper (Figure 9-29), which is located along the right-hand side of the circuit board (when looking at the unit from the front).

5 Move the jumper to pins 1-2, as shown in Figure 9-30.

6 Carefully replace the top cover of the unit, with the MOTU logo facing the front of the unit, taking care to make sure that the top edges of the front and rear faceplates fit into the grooves on the underside of the top cover.

7 Secure the top cover with the two screws.

⚠ Be sure to fully reinstall the cover as described above in steps 6 and 7 before attempting to power on the unit after this procedure.

8 Plug in the unit to confirm that it powers on immediately, as soon as it receives power.

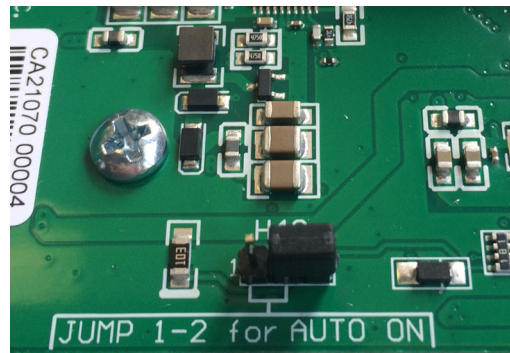

Figure 9-29: Normal power-on mode (jumper is in position 2-3).

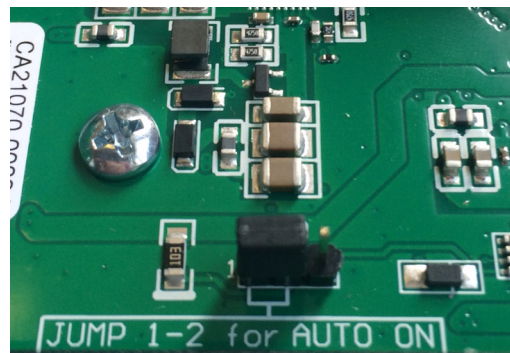

Figure 9-30: Move the jumper to position 1-2 for Auto-on mode.

- 24-bit
 - optical 10
- 2x SMUX mode 13, 34
- A**
 - Ableton Live 45, 46
 - ADAT optical 10
 - connecting 34
 - settings 13
 - Analog inputs/outputs 33
 - making connections to 33
 - Apple
 - Garage Band 46
 - Logic Pro 46
 - ASIO driver 46
 - ASIO monitoring 47
 - Attack
 - Compressor 54, 56
 - Audio
 - MIDI Setup utility 29
 - Audio interface preset 7, 39
 - Audio Tools 61
 - AudioDesk 24, 30, 45, 46
 - Aux Mix Target 17
 - Aux Mixing tab 17
 - Avid
 - Pro Tools 46
- B**
 - Balanced analog 33
 - Buffer Size 12, 28
- C**
 - Check for Updates 14
 - Chrome 11
 - Class compliance 27
 - Clear Password 14, 44
 - Clock Mode 12
 - Clock section (LCD) 44
 - Cockos Reaper 46
 - Compressor effect 16, 55
 - Computer Channel for LTC-to-MTC
 - Conversion 14
 - Computer Setup 14
 - Computer Volume Controls option 14
 - Controller
 - connecting 35
 - Converter mode
 - setup/example 40
 - Converters 10
 - Core Audio driver 46
 - Core MIDI
 - Audio MIDI Setup 29
 - benefits 29
 - Correlation Meter 73
 - Cubase 45, 46
 - clock source 45
 - sample rate 45
 - CueMix FX
 - Devices menu 21
 - installation 61
 - Customer
 - support 80

- D**
 - DAT
 - connecting 34
 - Device tab 12, 13
 - Devices menu 61
 - Digital converter (see Optical converter)
 - Digital Performer 45, 46
 - Direct hardware playthrough 47
 - Direct ASIO monitoring 47
 - Direct hardware playthrough 47
 - Discovery app 7, 28
 - Driver installation 7, 11
 - Drivers
 - installing USB drivers 27
 - DSP
 - effects 53
 - meter 59
 - resources 59
 - DSP Usage 18, 59

- E**
 - Effects 53
 - Enable Jam Sync 14
 - EQ 54
 - enabling 54
 - filter types 54
 - frequency 54
 - gain 54
 - Q 54

- F**
 - Factory Defaults 44
 - Firefox 11
 - Firmware
 - version 14
 - Firmware updates 12
 - Follow Solo 16, 19
 - Four-band EQ 54
 - Frequency
 - EQ 54
 - From Computer 15
 - Front panel 43
 - menu navigation 43
 - metering 43

- G**
 - Gain
 - EQ 54
 - reduction 56
 - reduction (Leveler) 58
 - Garage Band 45, 46
 - clock source 45
 - sample rate 45
 - Gate effect 16, 54
 - GR (gain reduction) 56

- H**
 - Headphone outputs 9
 - Headphones
 - connecting 32
 - High pass filter 53
 - Host
 - Buffer Size 12, 28

- Safety Offset 12, 28

- I**
 - ID knob/button 12, 43
 - Input banks 13
 - Input settings 12
 - Inputs
 - optical 10
 - S/PDIF (RCA) 10
 - Installation
 - iOS connection 31
 - QuickStart Guide 7
 - software 27
 - USB connection 31
 - Interface + mixer preset 7, 40
 - iOS operation 27, 31
 - iPad
 - QuickStart 7
 - iPad/iPhone support 27
- J**
 - Jam Sync 14
 - Jam sync 36
- K**
 - Keyboard controller
 - connecting 35
- L**
 - Latency 12, 27, 28, 46, 48
 - LCD
 - contrast 44
 - menu 43
 - Leveler 16, 57
 - Lightpipe 34
 - Limit button 58
 - Live 46
 - Live recording with monitor mixing preset
 - 7, 40
 - Lock button 15
 - Logic Pro 46
 - Logic Pro/Express 45
 - clock source 45
 - sample rate 45
 - LTC
 - to MTC conversion 51
 - LTC Input Source 14
 - LTC Setup 35
- M**
 - Mac OS X 45
 - input and output names 50
 - system requirements 25
 - Main outs
 - front panel volume control 33
 - making connections to 33
 - Makeup gain 58
 - Mic inputs
 - preamp gain/pad/48V 9
 - Mic/guitar inputs 33
 - Mic/instrument inputs 33
 - MIDI
 - connections 35
 - jacks 10

- overview 24
- software setup 29
- thru 35
- Windows driver installation 29
- MIDI Thru 44
- MIDI Time Code 14, 51
- Mixer
 - accessing 16
 - aux bus 20
 - connecting 32
 - effects 53
 - group bus 21
 - input channel strip 18
 - main mix channel strip 19
 - Monitor channel strip 19
 - overview 16
 - Reverb bus 21
 - schematics 83
 - Setup 13
 - stand-alone operation 53
- Mixing tab 16
- Monitoring
 - thru main outs 33
- MOTU
 - Audio Tools 61
 - AudioDesk 46
 - Control web app 11
 - Digital Performer 46
 - Discovery app 7, 11, 28
 - Pro Audio
 - WebUI Setup 11
 - Pro Audio ASIO driver 46
 - Pro Audio Control web app 7, 11-21
 - Aux Mixing tab 17
 - Device tab 12, 13
 - Mixing tab 16
 - Routing tab 15
 - Pro Audio Installer 7, 11
- MOTU Pro Audio WebUI Setup 28
- MTC 14, 51

N

- Nuendo 45, 46
 - clock source 45
 - sample rate 45

O

- Optical
 - connectors 10, 34
 - S/PDIF 34
- Optical Converter preset 7, 40
- Optical converter preset
 - setup/example 40
- Optical converter with mixing preset 41
- Optical setup 13
- Optimization 48
- OS X audio software
 - clock source 45
 - sample rate 45
- Oscilloscope 65
- Output banks 13
- Output settings 12
- Outputs

- optical 10
- S/PDIF (TOSLink) 10

P

- Packing list 25
- Pad 33
- Password protection 14
- Patch thru
 - latency 48
- Performance 48
- Phantom power 33
- Phase Analysis 73
- Phone outputs 9
- Power supply
 - jack 10
- Power switch 43
- PRE switch 16
- PreDelay 58
- Prefader button 17
- Presets 7, 12
 - Mixer tab 16
 - overview 39
 - Routing tab 15
- Pro Audio Control web app 7, 11-21
 - Aux Mixing tab 17
 - Device tab 12, 13
 - Mixing tab 16
 - Routing tab 15
- Pro Tools 45, 46
- Processing 53

Q

- Q 54
- Quick Setup window 7
- QuickStart Guide 7

R

- Ratio
 - Compressor 55
- Reaper 45, 46
- Reason 45
 - Propellerhead Reason 46
- Reboot 14
- Registration 25
- Release
 - Compressor 54, 56
- Restore Factory Presets 14
- Reverb 58-59
 - design section 58
 - enabling/disabling 58
 - predelay 58
 - routing to/from 58
 - time 58, 59
 - width 59
- RMS mode 56
- Routing tab 15

S

- S/PDIF 24
 - connection 34
 - optical 10
 - RCA 10
 - sync 34
- S/PDIF (optical) 34

- Safari 11
- Sample rate 12
- Samplers
 - connecting 32
- SC button 19
- Schematics 83
- Set password 14
- SMPTE sync 35
- SMPTE time code 14
- SMUX 34
- Software
 - installation 27
- Software installer 7, 11
- Solo bus 19
- Solo Clear button 18
- SONAR 45
- Sound module
 - connecting 35
- Soundtrack Pro
 - clock source 45
 - sample rate 45
- Stage monitors
 - connecting 32
- Stand-alone mixer preset 7
- Stand-alone operation 43
- Standard (optical setting) 34
- Steinberg
 - Cubase 46
 - Nuendo 46
- Stop Jam Sync 14
- Studio setup (example) 32
- Synchronization
 - SMPTE time code 35
- Synths
 - connecting 32
- System Information 14
- System requirements
 - minimum 25
 - recommended computer 25

T

- Technical support 80
- Threshold
 - Compressor 55
- Time code 14
- Time code sync 35
- To Computer 15
- TOSLink 10, 13, 34
- Trim 33
- Troubleshooting 79
- TRS analog inputs/outputs 33
- TRS connectors 33
- Type II (Legacy) optical setting 34

U

- UltraLite-mk4
 - setup example 32
 - specifications 81
 - summary of features 23
- Unbalanced analog 33
- Update From File 14
- USB
 - class compliance 27

installing drivers 27

V

View Personal Mix 17

W

Wave driver 46

WDM (Wave) Driver 28

Width

 reverb 59

Windows

 shortcut 28

 system requirements 25

 WDM (Wave) driver 28

X

X-Y Plot 70

