

# Instruction Manual

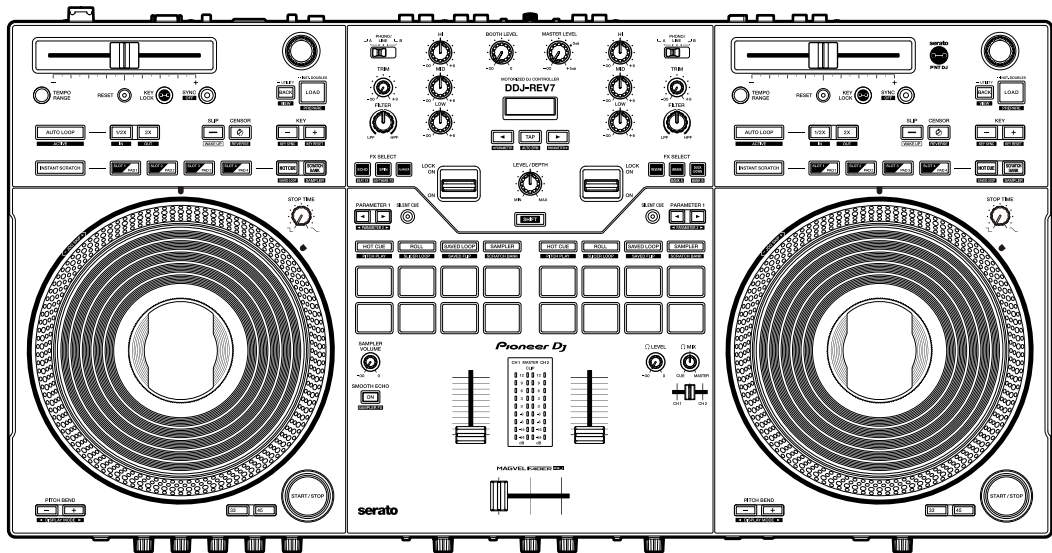

DJ Controller

# DDJ-REV7

[pioneerdj.com/support/](http://pioneerdj.com/support/)

[serato.com](http://serato.com)

For FAQs and other support information for this product, visit the websites above.

*Pioneer Dj*

**serato**

---

---

# Contents

<b>Before you start</b> .....	<b>6</b>
How to read this manual .....	6
What's in the box.....	6
User guides .....	7
<b>DJ software</b> .....	<b>8</b>
Serato DJ Pro.....	8
Installing Serato DJ Pro .....	9
Activating Pitch 'n Time DJ .....	11
<b>Part names</b> .....	<b>12</b>
Top panel .....	12
Front panel .....	13
Rear panel.....	13
On Jog Display .....	15
<b>PC/Mac setup</b> .....	<b>21</b>
Setting Utility .....	23
<b>Connections (basic styles)</b> .....	<b>31</b>
Connecting to the input terminals.....	31
Connecting to the output terminals .....	33
Step-by-step connections.....	34
<b>Using Serato DJ Pro</b> .....	<b>35</b>
Launching Serato DJ Pro .....	35
Importing a track .....	36
<b>Loading a track</b> .....	<b>38</b>
Browse section .....	38
Loading a track to a deck .....	39
<b>Playback</b> .....	<b>40</b>

Deck section.....	40
Play/pause .....	42
Reverse playback.....	42
Adjusting the playback speed (tempo control) .....	42
Adjusting the playback speed without changing the pitch (Key Lock)...	43
Using the jog wheels .....	43
Adjusting the time until playback stops .....	44
Beat Sync.....	44
Key Sync .....	45
<b>Looping.....</b>	<b>46</b>
Loop section .....	46
Using a loop .....	47
<b>Using Performance Pads and Deck Pads.....</b>	<b>49</b>
Performance Pads section .....	49
Hot Cue mode .....	50
Roll mode .....	51
Saved Loop mode .....	52
Sampler mode .....	53
Pitch Play mode .....	54
Slicer Loop mode .....	55
Saved Flip mode .....	57
Scratch Bank mode .....	59
Deck Pads section .....	60
Hot Cue mode .....	60
Scratch Bank mode .....	61
Saved Loop mode .....	62
Sampler mode .....	63
<b>Slip .....</b>	<b>64</b>
Turning Slip mode on .....	65

<b>Instant Scratch</b> .....	<b>66</b>
Instant Scratch section .....	66
Using Instant Scratch .....	67
<b>Audio output</b> .....	<b>68</b>
Channel section/master section .....	68
Outputting sound .....	70
Adjusting the sound.....	71
Setting the faders .....	71
<b>Monitoring sound</b> .....	<b>74</b>
Headphones section .....	74
Monitoring with headphones .....	75
Booth section .....	75
Using a booth monitor .....	76
<b>Microphone</b> .....	<b>77</b>
MIC section .....	77
Using a microphone .....	78
Using the microphone echo .....	78
<b>External input</b> .....	<b>79</b>
Mixing sounds of external inputs .....	79
Using AUX.....	80
<b>Filter</b> .....	<b>81</b>
Filter section .....	81
Using a filter or an effect .....	81
Effect types and settings .....	82
<b>Beat FX/software effects</b> .....	<b>84</b>
Effects section.....	84
Effects section display.....	85
Using Beat FX/software effects .....	86
Beat FX types and settings .....	87

Using FX Bank .....	93
Using FX Trigger mode .....	94
<b>Smooth Echo.....</b>	<b>95</b>
Smooth Echo section .....	95
Using Smooth Echo .....	95
<b>Settings.....</b>	<b>97</b>
Changing the settings .....	97
Utility settings .....	98
Replacing the slip sheets .....	103
<b>Using other types of DJ software (via MIDI).....</b>	<b>105</b>
<b>Specifications .....</b>	<b>106</b>
Block diagram .....	109
<b>Additional information .....</b>	<b>111</b>
Troubleshooting .....	111
LCD display .....	115
Trademarks and registered trademarks .....	115
Software license notice .....	116
Cautions on copyrights.....	118

---

---

# Before you start

---

---

## How to read this manual

- Thank you for choosing this Pioneer DJ product.  
Be sure to read this manual, the “Quick Start Guide” and the “Precautions for Use” which are also included with this product. These documents include important information that you should understand before using the unit.
- In this manual the names of buttons, knobs and terminals that appear on the product, and the names of buttons, menus etc. in the software on your PC/Mac or mobile device, are indicated within square brackets ([ ]). (e.g. **[File]**, **[CUE]** button)
- Please note that the software screens and their specifications, as well as the external appearance and specifications of the hardware, are subject to change without notice.
- Please note that depending on the operating system version, web browser settings, etc. operation may differ from the ways described in this manual.
- Please note that the language on the screens of the software described in this manual may differ from the language on your screen.

---

---

## What’s in the box

- AC adapter
- Power cord
- USB cable<sup>\*1</sup>
- Warranty (for some regions)<sup>\*2</sup>
- Quick Start Guide
- Precautions for Use
- Serato DJ Pro Expansion Pack voucher<sup>\*3</sup>
- Marking sticker<sup>\*4</sup>

\*1 One USB cable is included with the unit. To connect 2 devices to the unit, use an additional cable that conforms to USB 2.0 standards.

\*2 Only products in Europe.

Products in North America and Japan include warranty information in the “Precautions for Use”.

- \*3 The voucher code needed to activate your Expansion Pack can't be reissued. Keep it in a safe place to be sure you don't lose it.
- \*4 Attach to the top of the jog wheel to indicate the playback position.  
You can also use the digital marker on the On Jog Display to indicate the playback position (pages 16, 17, 19, 20)

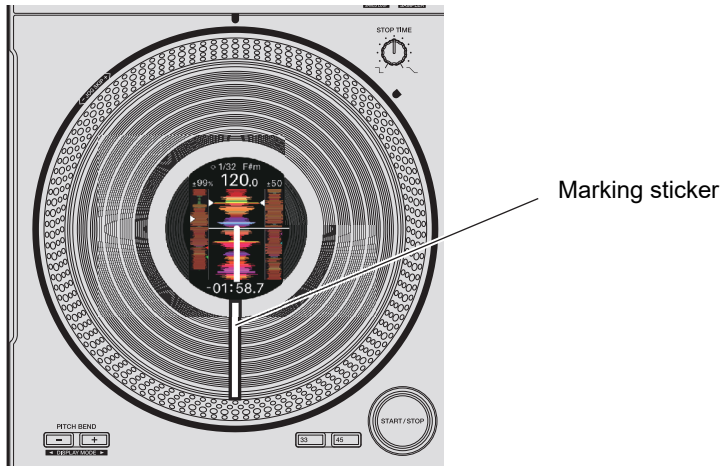

---

---

## User guides

### ❖ Serato DJ Pro software manual

Refer to the following site.

[serato.com/dj/pro/downloads](http://serato.com/dj/pro/downloads)

---

---

# DJ software

You can DJ with this unit by connecting it to a PC/Mac running Serato DJ Pro.

---

---

## Serato DJ Pro

Serato DJ Pro is DJ software from Serato.

The Serato DJ Pro software isn't included with the unit. Download the software from the URL below.

[serato.com](http://serato.com)

- For information on the latest system requirements, compatibility, and supported operating systems, visit the URL below.

[serato.com/dj/pro/downloads](http://serato.com/dj/pro/downloads)

- Operation isn't guaranteed on all PC/Mac models, even if the system requirements are met.
- Depending on power-saving settings and other conditions of your PC/Mac, the CPU and hard disk may not provide sufficient processing capabilities. For laptops in particular, make sure the PC/Mac is in the best condition to provide constant high-level performance when using Serato DJ Pro (for example by keeping the AC power connected).



---

# Installing Serato DJ Pro

## ❖ Installation procedure (for Mac)

Do not connect your Mac to the unit until the installation is complete.

- Close all applications running on your Mac before starting the installation.

### 1 Unzip the downloaded Serato DJ Pro software file.

### 2 Double-click the unzipped software file.

The installer launches.

### 3 Read the License Agreement terms carefully.

If you agree to the terms, click [Agree].

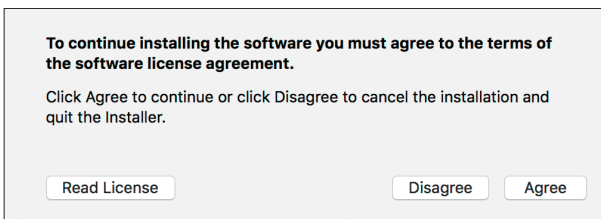

- If you don't agree to the License Agreement terms, click [Disagree] to cancel the installation.

### 4 Click [Install].

### 5 Follow the on-screen instructions to complete the installation.

### 6 Click [Close].

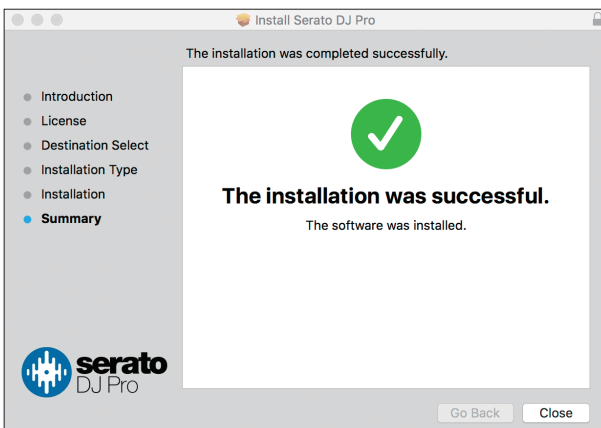

The installer closes.

## ❖ Installation procedure (for Windows)

**Do not connect your PC (Windows) to the unit until the installation is complete.**

- You'll need admin rights to install the software on your PC (Windows).
- Close all applications running on your PC (Windows) before starting the installation.

### 1 Unzip the downloaded Serato DJ Pro software file.

### 2 Double-click the unzipped software file.

The installer launches.

### 3 Read the License Agreement terms carefully.

**If you agree to the terms, select [I agree to the license terms and conditions] and then click [Install].**

- If you don't agree to the License Agreement terms, click [**Close**] to cancel the installation.

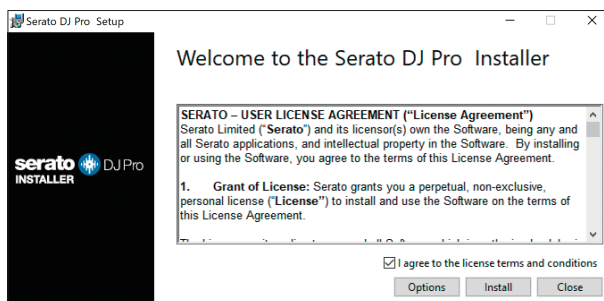

The installation completion screen appears when it's finished.

### 4 Click [**Close**].



The installer closes.

---

## Activating Pitch 'n Time DJ

To use Pitch 'n Time DJ with Serato DJ Pro, activate it on the “my serato” screen. You'll need an internet connection to do this.

For Pitch 'n Time DJ support information, visit the URL below.

[serato.com](http://serato.com)

- 1 Connect your PC/Mac to the unit with a USB cable.**
- 2 Launch Serato DJ Pro.**
- 3 Click [My Serato].**
- 4 Log in with the account registered to [serato.com](http://serato.com).**
- 5 Click [Enter Voucher Code].**
- 6 Enter the supplied voucher code, then click [Activate].**
- 7 Click the [SETUP] icon in the upper-right area of the screen.**
- 8 Click the [Expansion Packs] tab.**
- 9 Select [Pitch 'n Time DJ].**
- 10 Mark the [Enable Pitch 'n Time DJ] check box.**
- 11 Click the [SETUP] icon.**

The setup screen closes.

- 12 Restart Serato DJ Pro.**

---

---

# Part names

---

---

## Top panel

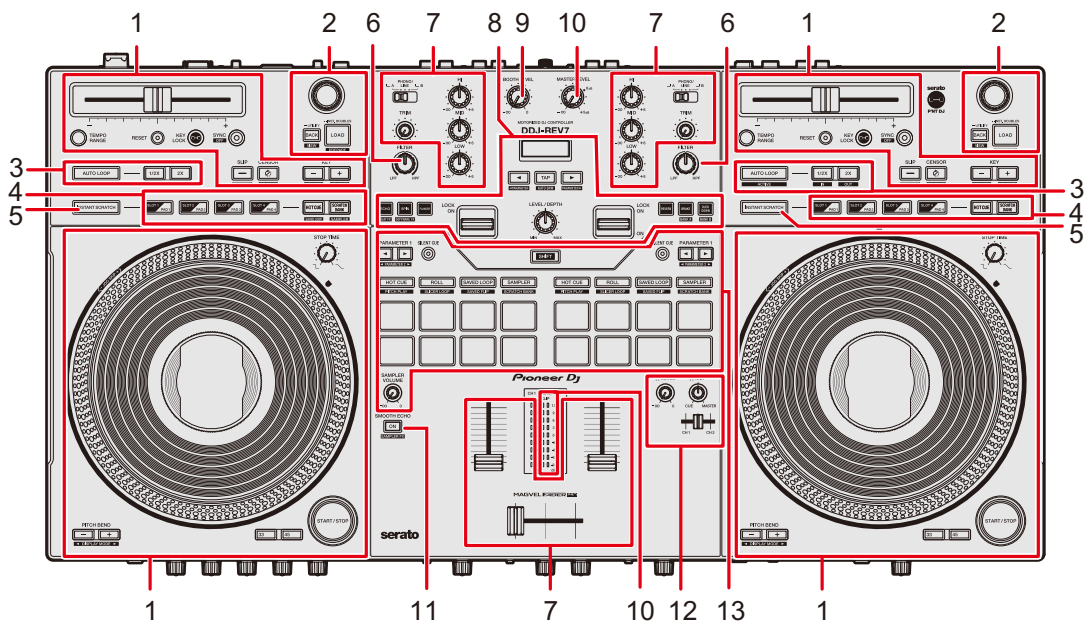

1. **Deck section** (page 40)
2. **Browse section** (page 38)
3. **Loop section** (page 46)
4. **Deck Pads section** (page 60)
5. **INSTANT SCRATCH button** (page 66)
6. **FILTER knob** (page 81)
7. **Channel section** (page 68)
8. **Effects section** (page 84)
9. **BOOTH LEVEL knob** (page 75)
10. **Master section** (page 68)
11. **SMOOTH ECHO button** (page 95)
12. **Headphones section** (page 74)
13. **Performance Pads section** (page 49)

## Front panel

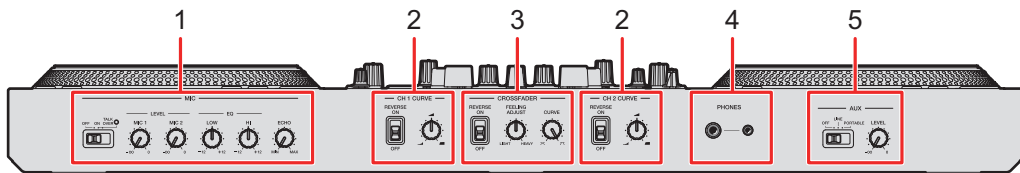

1. **MIC section** (page 77)
2. **CH Curve section** (page 71)
3. **Crossfader section** (page 72)
4. **PHONES terminals** (stereo phone plugs Ø 6.3 mm, Ø 3.5 mm) (page 74)

Connect headphones to one of the terminals (1/4" stereo jack or 3.5 mm stereo mini-jack). If you use both terminals at the same time, when you insert or remove headphones into/from a terminal, the volume for headphones connected to the other terminal may suddenly increase or decrease.

5. **AUX section** (page 80)

## Rear panel

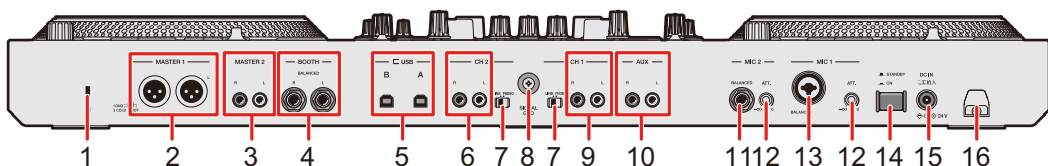

1. **Kensington security slot**

Connect a cable lock.

2. **MASTER 1 terminals (balanced XLR)**

Connect to analog input terminals on a power amplifier, etc.

- Use the terminals for balanced output only. Connecting the terminals to unbalanced inputs (RCA, etc.) with an XLR-RCA conversion cable (conversion adapter), etc. results in unwanted noises and/or poor sound quality.
- Do not connect a power cord from another product to the terminals.
- Do not connect to a terminal that can supply phantom power.

## 3. **MASTER 2 terminals (RCA)**

Connect to analog input terminals on a power amplifier, etc.

- Use the [**MASTER 2**] terminals for unbalanced input (RCA, etc.).

## 4. **BOOTH terminals (1/4"/6.35 mm, TRS)** (page 76)

Connect a booth monitor.

- Use the terminals for balanced output only. Connecting the terminals to unbalanced inputs results in unwanted noises and/or poor sound quality.

## 5. **USB ports** (page 31)

Connect a PC/Mac.

## 6. **CH 2 terminals** (pages 31, 79)

## 7. **LINE/PHONO selector switch** (page 79)

Set to [**LINE**] when you connect a DJ player or line-level output device to the [**CH 1**]/[**CH 2**] terminals, and set to [**PHONO**] when you connect a turntable or phono-level (MM cartridge) output device to the terminals.

## 8. **Signal GND terminal**

Connect a turntable's ground wire.

Reduces unwanted noises that occur when a turntable is connected to the unit.

## 9. **CH 1 terminals** (pages 31, 79)

## 10. **AUX terminals**

Connect a line-level output device.

## 11. **MIC 2 terminal (1/4"/6.35 mm, TRS)** (page 78)

## 12. **ATT. knob** (page 78)

Adjusts the sound level input to the [**MIC 1**] and [**MIC 2**] terminals.

- Microphone gain varies depending on the microphone you use. Adjust the sound level according to your microphone before using it.

To adjust the microphone volume during a performance, use the [**LEVEL (MIC 1, MIC 2)**] knobs on the front panel (page 77).

## 13. **MIC 1 terminal (XLR or 1/4"/6.35 mm, TRS)** (page 78)

## 14. **⏻ button**

Turns the unit on (⏻) and off (■).

## 15. **DC IN terminal**

Connect to a power outlet with the supplied AC adapter and power cord (page 31).

## 16. **Cord hook** (page 32)

Put the cord of the AC adapter through the hook to fix it to the unit.

## On Jog Display

When a track from Serato DJ Pro is loaded to the unit or a scratch sound is loaded in Instant Scratch mode, the information is displayed on the jog wheel (On Jog Display).

You can switch On Jog Display to show WAVEFORM MODE, VIRTUAL DECK MODE, ARTWORK DISPLAY, or DJ LOGO DISPLAY by pressing the [33] or [45] button while holding the [SHIFT] button.

 Read more: Deck section (page 40)

---

## WAVEFORM MODE

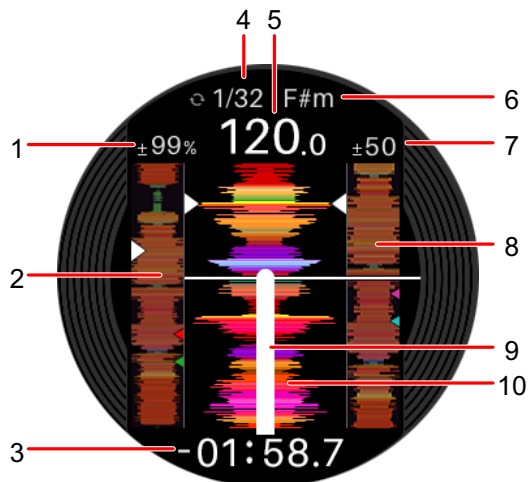

### 1. Playback speed

Displays the playback speed set by the [TEMPO] slider.

### 2. Overall waveform

Displays the overall waveform for the track.

### 3. Time display

Displays the remaining time or elapsed time.

- You can choose to display remaining time or elapsed time in [Time Mode] in the Setting Utility (page 27).

### 4. Loop indicator

Displays the number of beats for the loop in blue when a loop is playing.

5. **BPM**

Displays BPM for a track.

6. **Key**

Displays the current key for a track.

7. **Playback speed adjustment range**

Displays the adjustable range from the original playback speed.

8. **Detailed waveform for a track loaded on the other deck**

Displays a detailed waveform for a track loaded on the other deck.

9. **Digital marker**

Displays the playback point. It rotates during playback and stops when playback is paused.

- Press the [33] or [45] button twice to display or hide the marker.
- The digital marker isn't displayed by default.

10. **Detailed waveform**

Displays the detailed waveform of the loaded track around the current playback point.

- Press the [PITCH BEND -] or [PITCH BEND +] button while pressing the [SHIFT] button to enlarge or reduce the waveform.



---

## VIRTUAL DECK MODE



1. **Loop indicator**  
Displays the number of beats for the loop in blue when a loop is playing.
2. **Playback speed**  
Displays the playback speed set by the [TEMPO] slider.
3. **Elapsed time**
4. **Remaining time**
5. **Slip indicator**  
Lights up when Slip mode is turned on.
6. **BPM**  
Displays BPM for a track.
7. **Key**  
Displays the current key for a track.
8. **Key shift**  
Displays the amount of shift for the current key from the original key.
9. **Digital marker**  
Displays the playback point. It rotates during playback and stops when playback is paused.
  - Press the [33] or [45] button twice to display or hide the marker.
  - The digital marker isn't displayed by default.

## 10. Playback point

Displays playback point. It rotates during playback and stops during pause.

## 11. Playback speed adjustment range

Displays the adjustable range from the original playback speed.

## 12. Hot Cue indicator

Displays a Hot Cue point closest to the current playback point.

- You can change the setting in [**Display HOT CUE INDICATOR**] in the Setting Utility (page 27) to display the same Hot Cue information as what's displayed on the virtual deck of Serato DJ Pro.

## 13. Key Sync indicator (page 45)

Lights up when Key Sync is turned on.

---

## ARTWORK DISPLAY

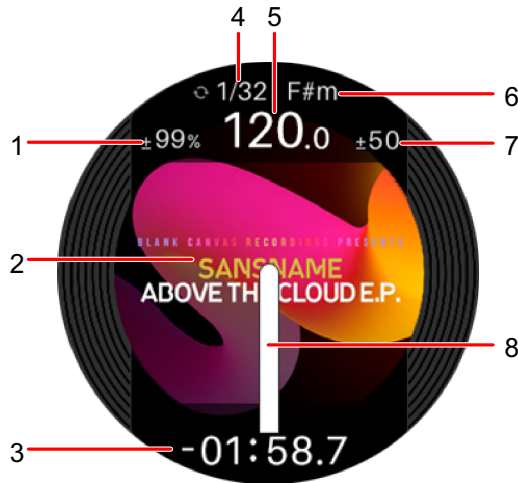

### 1. Playback speed

Displays the playback speed set by the [**TEMPO**] slider.

### 2. Artwork

Displays the track's artwork.

### 3. Time display

Displays the remaining time or elapsed time.

- You can choose to display remaining time or elapsed time in [**Time Mode**] in the Setting Utility (page 27).

## 4. Loop indicator

Displays the number of beats for the loop in blue when a loop is playing.

## 5. BPM

Displays BPM for a track.

## 6. Key

Displays the current key for a track.

## 7. Playback speed adjustment range

Displays the adjustable range from the original playback speed.

## 8. Digital marker

Displays the playback point. It rotates during playback and stops when playback is paused.

- Press the [33] or [45] button twice to display or hide the marker.
- The digital marker isn't displayed by default.

---

## DJ LOGO DISPLAY

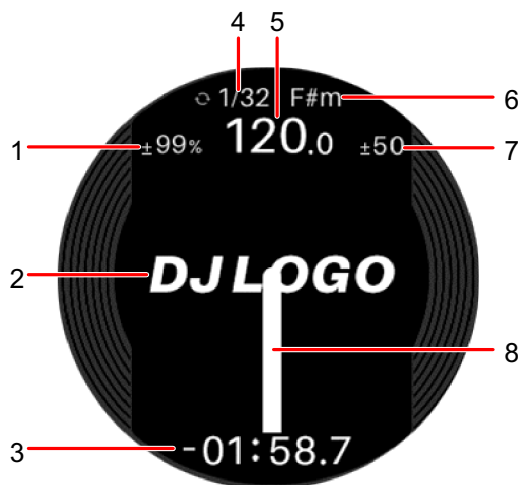

## 1. Playback speed

Displays the playback speed set by the [TEMPO] slider.

## 2. DJ logo

Displays a DJ logo.

- You can set a DJ logo in [DJ LOGO DISPLAY] in the Setting Utility (page 27).

## 3. Time display

Displays the remaining time or elapsed time.

- You can choose to display remaining time or elapsed time in [**Time Mode**] in the Setting Utility (page 27).

#### 4. **Loop indicator**

Displays the number of beats for the loop in blue when a loop is playing.

#### 5. **BPM**

Displays BPM for a track.

#### 6. **Key**

Displays the current key for a track.

#### 7. **Playback speed adjustment range**

Displays the adjustable range from the original playback speed.

#### 8. **Digital marker**

Displays the playback point. It rotates during playback and stops when playback is paused.

- Press the [**33**] or [**45**] button twice to display or hide the marker.
- The digital marker isn't displayed by default.

---

---

# PC/Mac setup

To input or output your PC/Mac's audio to/from the unit, install the dedicated audio driver software and/or Setting Utility on your computer.

If you install the audio driver software to your PC (Windows), Setting Utility will also be installed with the driver software.

If you use a Mac, install Setting Utility only.

- For information on the latest system requirements, compatibility, and supported operating systems, visit the URL below.

[pioneerdj.com/support/](http://pioneerdj.com/support/)

- Operation isn't guaranteed on all PC/Mac models, even if the system requirements are met.
- Operation isn't guaranteed when multiple units are connected to a PC/Mac.
- If a PC (Windows) without the dedicated audio driver software installed is connected to the unit, errors may occur on the PC.
- Malfunctions may occur due to incompatibility with other software installed on a PC/Mac.

---

## Installation

### ❖ Notes on installation

- Turn the unit off and disconnect the USB cable connected to the unit and the PC/Mac before installation.
- Close all applications running on the PC (Windows) before installation.
- You'll need admin rights to install the dedicated audio driver software to your PC (Windows).
- Read the License Agreement terms carefully before installation.
- If you quit the installation halfway through, perform the installation procedure from the beginning again.
- After the installation is complete, connect the PC/Mac to the unit.
- Operation isn't guaranteed on all PC/Mac models.

---

## Downloading the dedicated software

**1 Visit the URL below.**

[pioneerdj.com/support/](http://pioneerdj.com/support/)

**2 Click [Software & firmware updates].**

**3 Click [DDJ-REV7] under [DJ CONTROLLER].**

**4 Click [Drivers].**

**5 Click [Download link] and save the file.**

- Download the audio driver software dedicated to your PC/Mac.

---

## Installing the dedicated software

**1 Unzip the downloaded dedicated software.**

**2 Double-click the installation file.**

- Double-click “DDJ-REV7\_#.###.exe” if you’re using a PC (Windows), or “DDJ-REV7\_M\_#.###.dmg” → “DDJ-REV7SettingUtility.pkg” if you’re using a Mac (# indicates the version number of the software).

**3 Read the Software end user license agreement carefully. If you agree to the terms, mark the [Agree] check box and click [OK].**

- If you don’t agree to the license agreement terms, click [Disagree] (for Mac)/[Cancel] (for Windows) to cancel the installation.

**4 Follow the on-screen instructions to complete the installation.**

## Setting Utility

Once you've installed the dedicated software on your PC/Mac, you can use the Setting Utility to check and set connections between the unit and a PC/Mac.

---

### Launching Setting Utility

#### ❖ For Mac

- 1 Open the [Applications] folder in Finder.
- 2 Click [Pioneer] → [DDJ-REV7] → [DDJ-REV7 Setting Utility].

#### ❖ For PC (Windows)

- 1 Open the Start menu and click [Pioneer] → [DDJ-REV7 Setting Utility].

---

### Checking the status of the input selector switches on the unit

- 1 Click the [DDJ INPUT] tab.

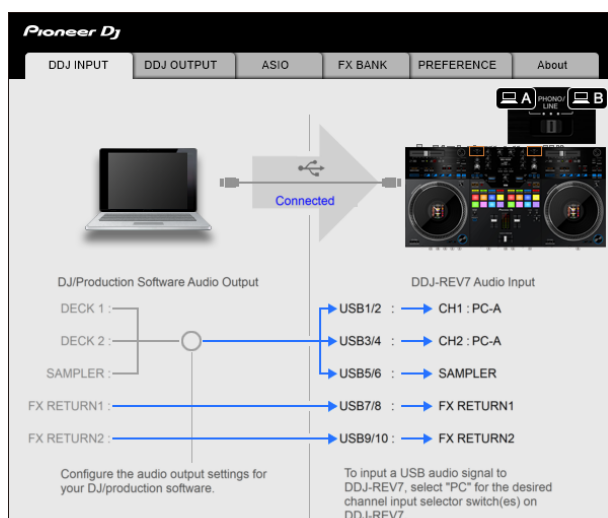

---

## Setting the audio data output from the unit to a PC/Mac

- 1 Click the [DDJ OUTPUT] tab.
- 2 Click the pull-down list under [DDJ-REV7 Audio Output] and select the audio data output from the unit to the PC/Mac.

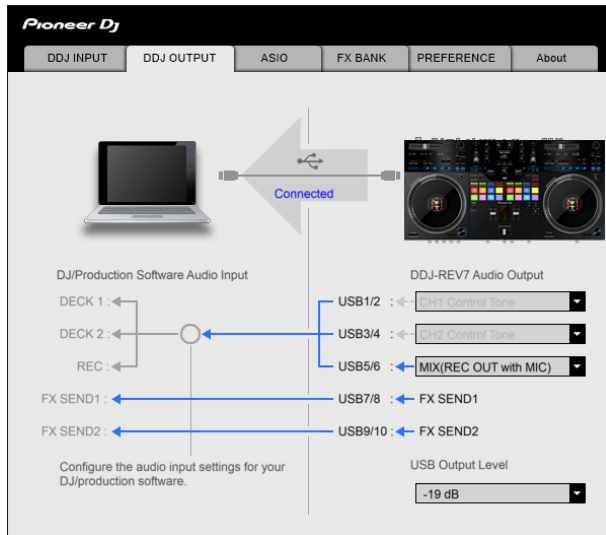

📖 Read more: Audio Output pull-down list (page 30)

- 3 Click the pull-down list under [USB Output Level] and select a level of volume to output from the unit.

- Set the volume in [USB Output Level] when you can't produce as much volume as you expect using the volume adjustment in your DJ application. Note that the sound may be distorted if you set the volume too high.



---

## Adjusting the buffer size (for Windows ASIO)

- Close any running applications (DJ applications, etc.) which use the unit as the default audio device before adjusting the buffer size.

**1 Click the [ASIO] tab.**

**2 Adjust the buffer size with the slider.**

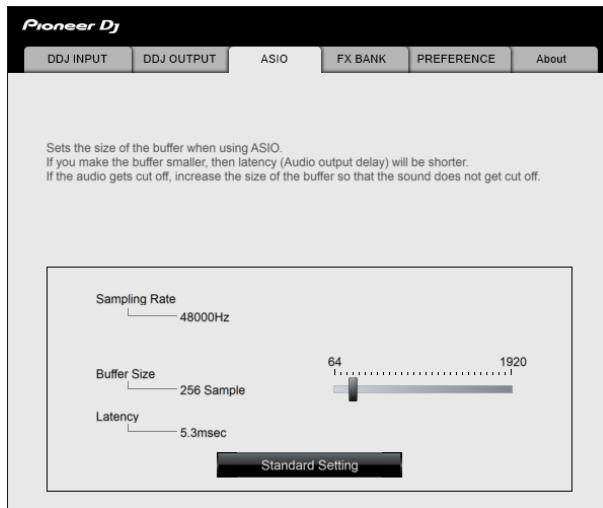

- Breaks in sound are less likely to occur if you set a large buffer size, but this increases lag time due to the latency of audio data transmission.

## Changing the assignment of the effects

You can change the effects assigned to the [FX SELECT] buttons and the [FILTER] knobs on the unit.

You can register the settings to [BANK A] or [BANK B], and call up the settings when you need to.

### 1 Click the [FX BANK] tab.

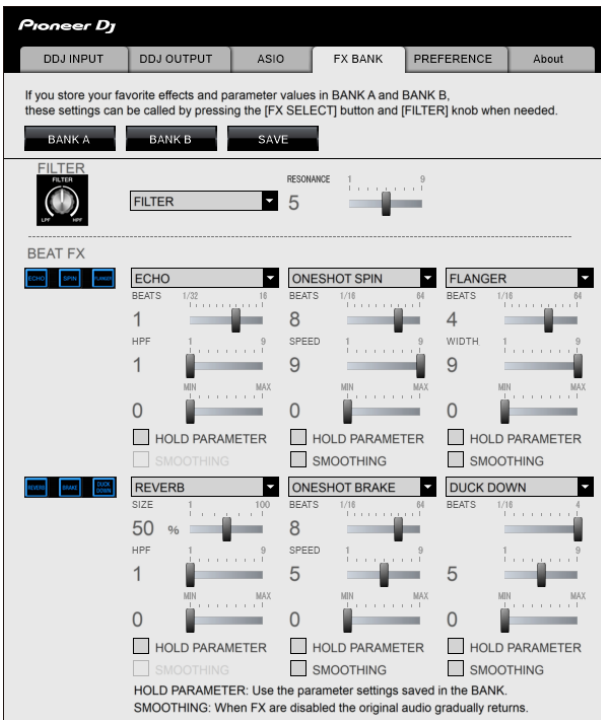

### 2 Select a filter or an effect to assign to the [FILTER] knobs from the [FILTER] pull-down list.

➤ Read more: Effect types and settings (page 82)

### 3 Select an effect to assign to each button from the pull-down list.

➤ Read more: Beat FX types and settings (page 87)

## 4 Mark the check box of [HOLD PARAMETER] and/or [SMOOTHING] as necessary.

- [HOLD PARAMETER]: Retains the parameters changed after the bank is called up.
- [SMOOTHING]: Gradually returns to the original sound after the effect turns off.

## 5 Click [SAVE], and save the bank.

The setting is saved to the FX Bank.

- You can also change the effects assigned to the [FX SELECT] buttons by turning the rotary selector while pressing a [FX SELECT] button.

---

## Changing the settings

### 1 Click the [PREFERENCE] tab.

### 2 Change the settings.

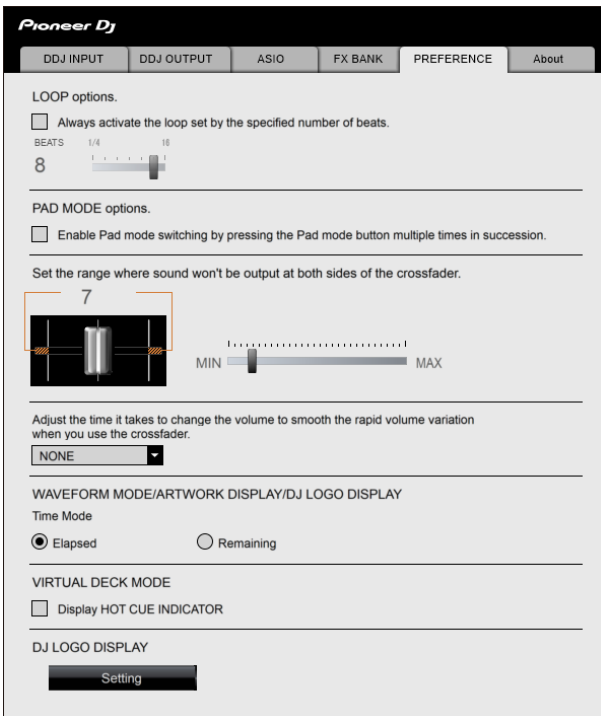

Setting item	Description
<b>LOOP options.</b>	<p>Mark the check box to activate the loop length set by the slider.</p> <p>Clear the check box to set the <b>[AUTO LOOP]</b> button on the unit to work as the Auto Beat Loop button.</p>
<b>PAD MODE options.</b>	<p>Mark the check box to enable Pad mode switching by pressing a Pad mode button twice in succession.</p> <ul style="list-style-type: none"> <li>When 2 computers (PC/Mac) are connected to the unit and the input selector switches for CH 1 and CH 2 are set to the different computers, this setting will be valid when it's enabled on each PC/Mac.</li> </ul>
<b>Set the range where sound won't be output at both sides of the crossfader.</b>	<p>Use the slider to set the range where sound won't be output at both ends of the crossfader.</p> <ul style="list-style-type: none"> <li>When 2 computers (PC/Mac) are connected to the unit and the input selector switches for CH 1 and CH 2 are set to <b>[PHONO/LINE]</b>, this setting is invalid (the default setting is applied).</li> </ul>
<b>Adjust the time it takes to change the volume to smooth the rapid volume variation when you use the crossfader.</b>	<p>Adjusts the time it takes to change the volume to smooth the rapid variation in the volume when you use the crossfader.</p> <ul style="list-style-type: none"> <li>When 2 computers (PC/Mac) are connected to the unit, <b>[NONE]</b> is automatically applied in the following cases. <ul style="list-style-type: none"> <li>The input selector switches for CH 1 and CH 2 are set to different computers (PC/Mac).</li> <li>The input selector switches for CH 1 and CH 2 are set to <b>[PHONO/LINE]</b>.</li> </ul> </li> </ul>
<b>Time Mode</b>	<p>Sets the time display (<b>[Elapsed]</b> or <b>[Remaining]</b>) in WAVEFORM MODE, ARTWORK DISPLAY, and DJ LOGO DISPLAY on the On Jog Display.</p>

Setting item	Description
<b>Display HOT CUE INDICATOR</b>	<p>Mark the check box to display the Hot Cue indicator in VIRTUAL DECK MODE.</p> <p>Clear the check box to display the same Hot Cue information in VIRTUAL DECK MODE as what's displayed on the virtual deck of Serato DJ Pro.</p>
<b>DJ LOGO DISPLAY</b>	<p>Sets an image to display in DJ LOGO DISPLAY.</p> <ol style="list-style-type: none"> <li>Click [<b>Setting</b>]. DDJ-REV7 Image Transfer Tool launches.</li> <li>Click [<b>Open</b>].</li> <li>Select an image (in bmp, jpeg, png, or gif format) to display on the On Jog Display.</li> <li>Click [<b>Transfer</b>]. The selected image is transferred to the unit and set.</li> <li>Switch to DJ LOGO DISPLAY (page 19) and check if the selected image is displayed on the On Jog Display.</li> </ol> <ul style="list-style-type: none"> <li>To clear the selected image, click [<b>Delete</b>] in DDJ-REV7 Image Transfer Tool.</li> <li>Close Serato DJ Pro before using DDJ-REV7 Image Transfer Tool.</li> </ul>

## Checking the firmware and dedicated software versions

### 1 Click the [About] tab.

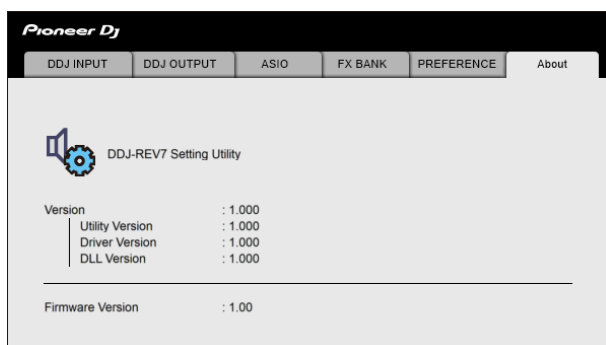

## Audio Output pull-down list

- CH 4 (USB 7/8), CH 5 (USB 9/10) is fixed to [FX SEND].

#: indicates channel number

CH 1 (USB 1/2), CH 2 (USB 3/4)	CH 3 (USB 5/6)
CH# Control Tone <sup>1</sup>	MIX(REC OUT with MIC) <sup>2</sup> <sup>4</sup>
MIX(REC OUT with MIC) <sup>2</sup> <sup>4</sup>	MIX(REC OUT without MIC) <sup>2</sup> <sup>4</sup>
MIX(REC OUT without MIC) <sup>2</sup> <sup>4</sup>	CROSSFADER A <sup>2</sup> <sup>3</sup>
Post CH# Fader <sup>2</sup>	CROSSFADER B <sup>2</sup> <sup>3</sup>
CROSSFADER A <sup>2</sup> <sup>3</sup>	MIC
CROSSFADER B <sup>2</sup> <sup>3</sup>	AUX
MIC	Post CH1 Fader <sup>2</sup>
AUX	Post CH2 Fader <sup>2</sup>

- <sup>1</sup> Available for software applications that support the function. Outputs sound at the volume input to the unit regardless of the [USB Output Level] setting.
- <sup>2</sup> For uses other than recording, be sure to set the DJ application so that no sound loop occurs. Sound may be input or output at an unintended volume level when a sound loop occurs.
- <sup>3</sup> The sound applied with the [ECHO], [TIME SWEEP ECHO], [DUCKING ECHO], [ECHO OUT], [SPIRAL], [HELIX OUT], [DELAY], or [DUCK DOWN] effect is output from [CROSSFADER A] or [CROSSFADER B].
- <sup>4</sup> The sound applied with the [REVERB] effect is output from [MIX(REC OUT with MIC)] or [MIX(REC OUT without MIC)].

---

---

# Connections (basic styles)

Turn the unit off and disconnect the power cord before connecting other units.

Connect the power cord after all the connections are complete.

- Use the supplied AC adapter and power cord.
- Read the instruction manuals for the devices you are going to connect with the unit.
- Connect the unit directly to your PC/Mac with the supplied USB cable or a USB cable that conforms to USB 2.0 standards (do not use a USB hub).

---

---

## Connecting to the input terminals

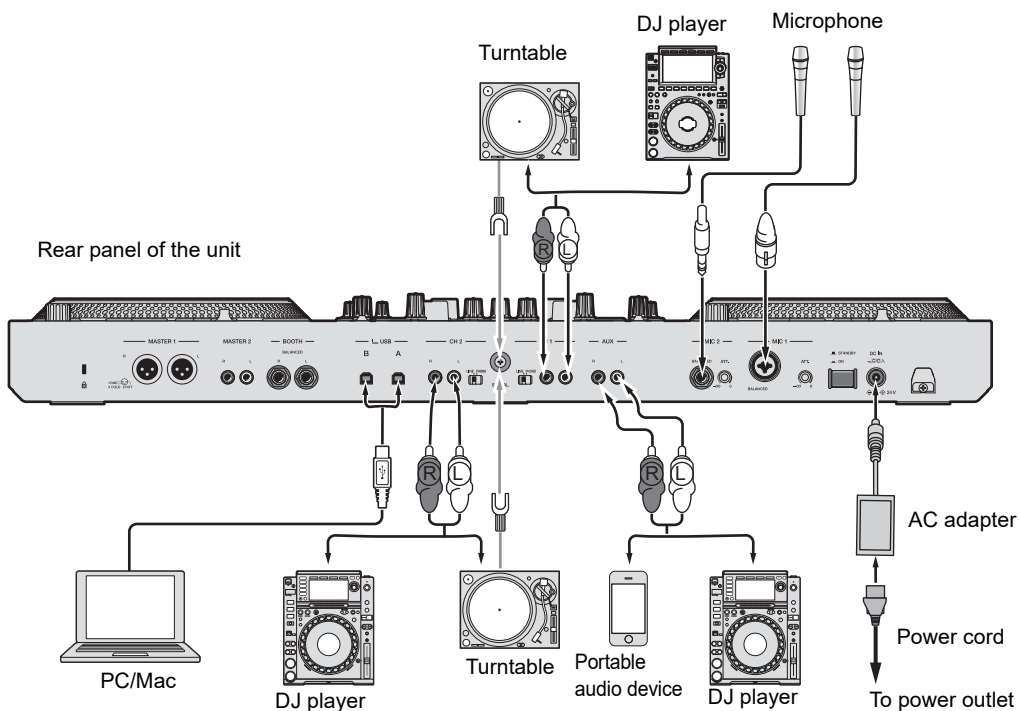

- Set the **[LINE/PHONO]** selector switches for the **[CH 1]** and **[CH 2]** terminals to **[PHONO]** when you connect a turntable to the terminals, and to **[LINE]** when you connect a DJ player to the terminals.

---

## Cord hook

Put the cord of the AC adapter through the cord hook to fix it to the unit.

It prevents accidental unplugging of the cord which would result in sound being interrupted.

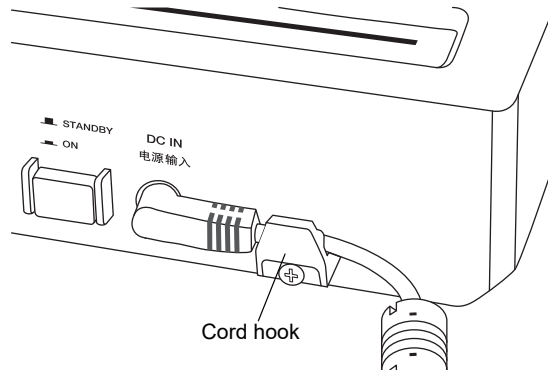

- Do not fix the cord with its root bent as this may break the cord and affect the unit's performance.



## Connecting to the output terminals

### ❖ Front panel

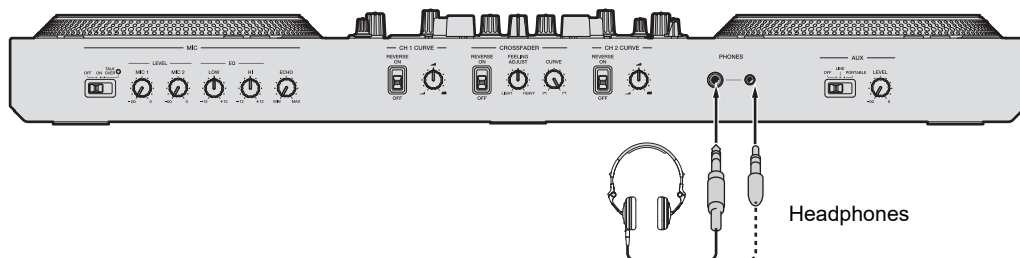

### ❖ Rear panel

Power amplifier,  
powered speakers, etc.

Power amplifier (for booth monitor),  
powered speakers, etc.

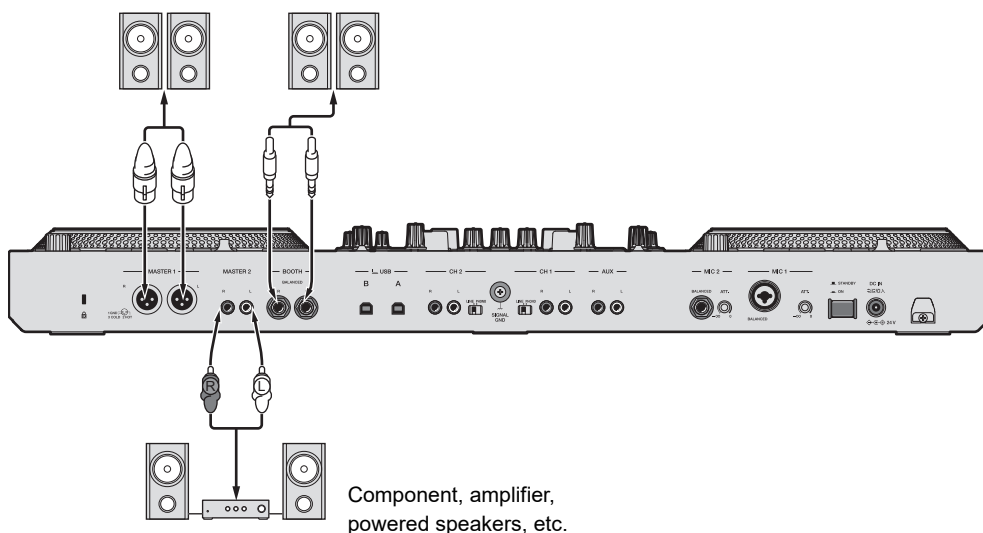

- Use the [**MASTER 1**] terminals for balanced output only. Connecting the terminals to unbalanced inputs (RCA, etc.) with an XLR-RCA conversion cable (conversion adapter), etc. results in unwanted noises and/or poor sound quality.
- Use the [**MASTER 2**] terminals for unbalanced input (RCA, etc.).
- Do not connect a power cord from another product to the [**MASTER 1**] terminals.
- Do not connect the [**MASTER 1**] terminals to a terminal that can supply phantom power.
- Use the [**BOOTH**] terminals for balanced output only. Connecting the terminals to unbalanced inputs with a TRS-RCA conversion cable (conversion adapter) or TS cable, etc. results in unwanted noises and/or poor sound quality.

## Step-by-step connections

- 1 Connect headphones to one of the PHONES terminals on the front panel.**
- 2 Connect an output device such as a power amplifier to the [MASTER 1] or [MASTER 2] terminals.**
  - To use a booth monitor, connect it to the [BOOTH] terminals.
  - To use an input device such as a microphone or DJ player, connect the device to the [CH 1] or [CH 2] terminals and set the [LINE/PHONO] selector switch to the relevant setting.
- 3 Connect a PC/Mac to the unit with a USB cable.**
- 4 Turn the PC/Mac on.**
- 5 Connect the AC adapter to the unit.**
- 6 Turn the unit on.**
  - The “Getting Windows ready” message may appear if you’re using a PC (Windows). Wait until the PC gets ready.
- 7 Turn on the device connected to the [MASTER 1] or [MASTER 2] terminals.**
  - If you use an input device such as a microphone or DJ player, turn the device on.

---

---

# Using Serato DJ Pro

The instructions described here relate to the basic use of Serato DJ Pro in tandem with this unit.

For more details on using Serato DJ Pro, refer to the Serato DJ Pro software manual (page 7).

- Connect your PC/Mac to the unit correctly beforehand (page 31).

---

---

## Launching Serato DJ Pro

### 1 Click [Serato DJ Pro] from the applications list on a PC/Mac.

Serato DJ Pro launches and the following screen appears.

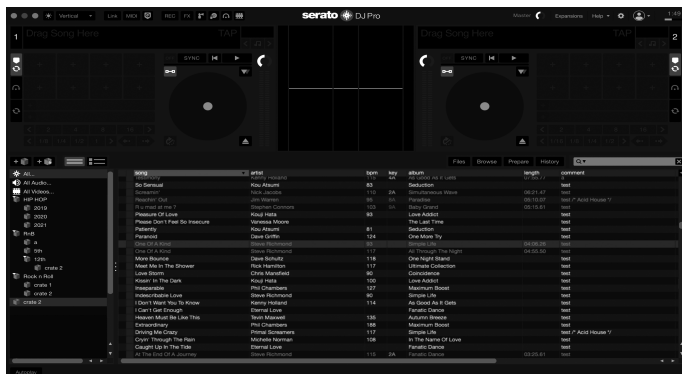

- When you launch Serato DJ Pro for the first time, [**BUY/ACTIVATE**] may be displayed on the right side of the screen. You don't need to activate the software or buy the license when you use the DDJ-REV7. If you want to use additional features (expansion packs) such as DVS, you'll need to buy them separately.

## Importing a track

The following instructions describe the basic method for importing tracks to Serato DJ Pro.

- For other importing methods, refer to the Serato DJ Pro software manual (page 7).
- In Serato DJ Pro, you can use libraries created with other DJ software from Serato Limited, such as Scratch Live, ITCH, Serato DJ Intro, and Serato DJ Lite.

To use a library created with Serato DJ Lite, you may need to analyze tracks when using Serato DJ Pro.

### 1 Click [Files] on the Serato DJ Pro screen.

The [Files] pane opens and the contents of the PC/Mac and any connected devices (e.g. external hard drives) are displayed.

### 2 Click a folder which include tracks you want to add to the library.

The folder is selected.

### 3 Drag and drop the selected folder to the crates pane.

A crate is created and the tracks are added to the library.

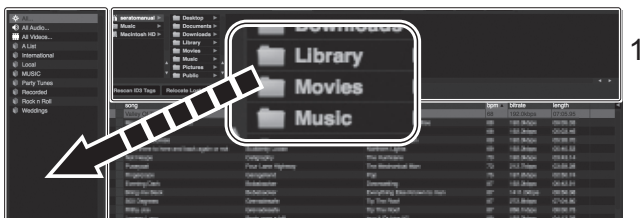

1. Files pane
2. crate pane

# Using Serato DJ Pro

- The screen below appears when a track is loaded in Serato DJ Pro. To switch the display, click **[Library]**, then click **[Vertical]** or **[Horizontal]** from the pull-down list.

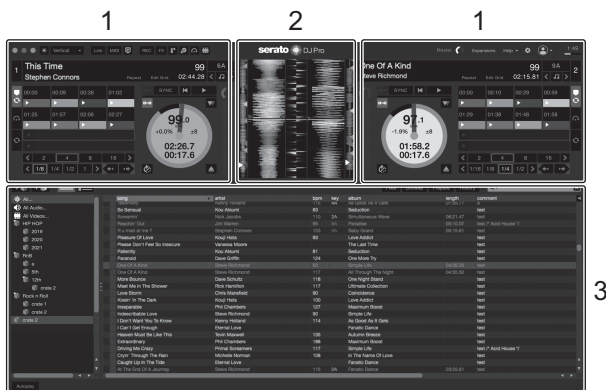

- 1. Deck pane**  
Displays the name of the loaded track as well as the artist name, track information such as BPM, and the overall waveform.
- 2. Waveform pane**
- 3. Browse pane**  
Displays tracks in a library or crate.

---

---

# Loading a track

You can use this unit to browse the Serato DJ Pro screen and load a track.

---

---

## Browse section

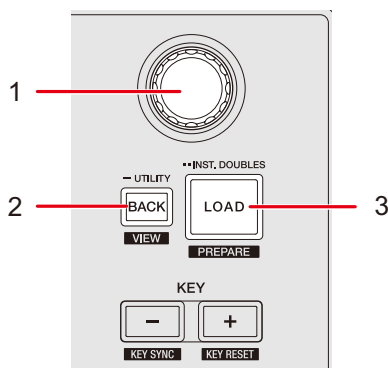

### 1. Rotary selector

Moves the cursor up and down in the library or on the crates pane of the Serato DJ Pro screen.

- Press when the cursor is in the library or on the crates pane to move the cursor between the library and crates pane.
- Press when the cursor is on the **[Files]** pane to move the cursor the next level down.
- Press when the cursor is on the **[Browse]** pane to move the cursor to the right category.

### 2. Back button (page 97)

Moves the cursor between the library and the crates pane of the Serato DJ Pro screen.

- Press when an item selected on the crates pane has a subcrate to open or close the crate.
- Press when the cursor is on the **[Files]** pane to move the cursor up a level.
- Press when the cursor is on the **[Browse]** pane to move the cursor to the left category.
- Press while pressing the **[SHIFT]** button to switch the layout of the Serato DJ Pro screen.

## 3. **LOAD button**

Loads the selected track to the deck.

- Press twice for Instant Doubles. The track that's loaded on the other deck will be loaded to the deck whose button you're pressing (the playback position will be the same).
- Press while pressing the [**SHIFT**] button to load a track on the [**Prepare**] pane of Serato DJ Pro.

---

## Loading a track to a deck

**1 Press the [**BACK**] button to move the cursor to the crates pane.**

**2 Turn the rotary selector to highlight a crate.**

**3 Press the rotary selector.**

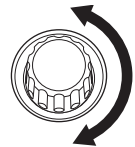

The cursor moves to the track list of the selected crate.

**4 Turn the rotary selector to highlight a track.**

**5 Press the [**LOAD**] button.**

The track is loaded to the corresponding deck.

---

---

# Playback

You can control Deck 1 with the left deck and Deck 2 with the right deck of the unit.

---

---

## Deck section

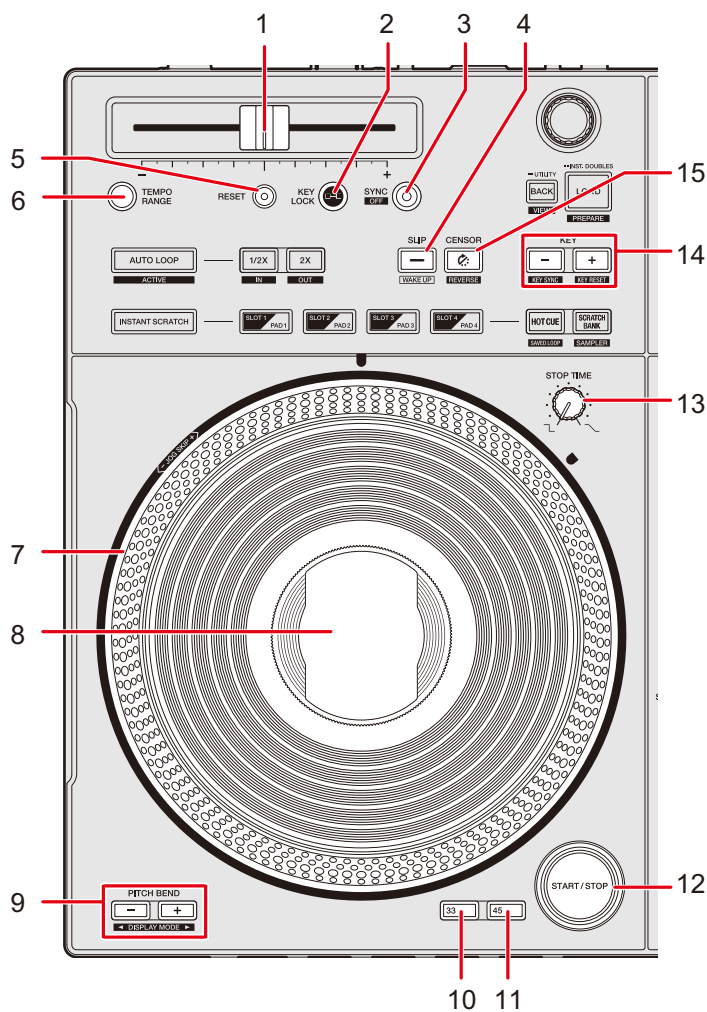

1. **TEMPO slider**  
Adjusts the playback speed of a track.
2. **KEY LOCK button**  
Turns Key Lock on and off.



### 3. **SYNC button**

The BPM and beatgrid of the track on the deck whose button is pressed is synchronized to the track loaded on the other deck.

### 4. **SLIP button** (page 64)

Turns Slip mode on and off.

### 5. **RESET button**

Resets to the track's original speed regardless of the [TEMPO] slider's setting.

### 6. **TEMPO RANGE button**

Sets the variable range of the [TEMPO] slider.

### 7. **Jog wheel**

- Do not place anything on it or apply strong force.

### 8. **On Jog Display** (page 15)

- Although the liquid crystal display (LCD) is manufactured with high-precision technology, there may be a few dead pixels that display only black, red, blue, or green dots. Depending on the angle you view the screen from, its color and brightness may be uneven. These factors are due to the nature of LCD technology and not a malfunction.

### 9. **PITCH BEND -, PITCH BEND + buttons** (page 16)

Adjusts the pitch temporarily.

### 10. **33 button** (page 15)

Sets the rotation speed of the jog wheel to 33 rpm.

### 11. **45 button** (page 15)

Sets the rotation speed of the jog wheel to 45 rpm.

### 12. **START/STOP button**

Plays or pause a track.

### 13. **STOP TIME knob**

Adjusts the length of time it takes playback to stop when you press the [START/STOP] button.

### 14. **KEY -, KEY + buttons**

Adjusts the key.

### 15. **CENSOR button**

Plays a track in reverse.

---

## Play/pause

### 1 Press the [START/STOP] button.

During pause: Starts playing the loaded track.

During playback: Pauses the track.



- The jog wheel rotates during playback.

---

## Reverse playback

### 1 Press the [CENSOR ] button.

The loaded track plays in reverse (Slip Reverse) until you release the button (page 64).

- Press the [CENSOR ] button while pressing the [SHIFT] button to continue reverse playback after you release the button. The operations of jog wheel rotation are also reversed. Press the [SHIFT] button and the [CENSOR ] button at the same time again to resume normal playback. The operations of jog wheel rotation return to the original direction.
- Maintaining reverse playback from one track to the next isn't possible.
- You may not be able to scratch if you start loop playback, etc. during reverse playback.

---

## Adjusting the playback speed (tempo control)

### 1 Move the [TEMPO] slider.

To the [+] side: Increases the playback speed.

To the [-] side: Decreases the playback speed.

- The variable range of the [TEMPO] slider changes in the order of  $\pm 8\% \rightarrow \pm 16\% \rightarrow \pm 50\% \rightarrow \pm 8\%$ ... each time you press the [TEMPO RANGE] button.
- Press the [RESET] button to reset to the track's original speed regardless of the [TEMPO] slider's setting.

---

## Adjusting the playback speed without changing the pitch (Key Lock)

If you turn Key Lock on, you can change the playback speed of a track using the [TEMPO] slider without changing the pitch.

### 1 Press the [Key Lock] button to turn Key Lock on.

The button lights up when Key Lock is turned on.

- Press the [Key Lock] button again to turn Key Lock off.

---

## Using the jog wheels

You can use the following features in combination with the jog wheel.

Function	Description
Scratch	Turn the jog wheel while touching the top during playback to scratch a track. Release the jog wheel to resume normal playback.
JOG SKIP	Turn the top of the jog wheel while pressing the [SHIFT] button to cycle through tracks with extra speed according to the rotation direction. If you release the [SHIFT] button, it changes to scratch operation and you can fine-adjust the playback position.

- You can set the rotation speed of the jog wheel to 33 rpm or 45 rpm by pressing the [33] or [45] button.

---

---

## Adjusting the time until playback stops

You can adjust the time it takes until the rotation of the jog wheel and playback stops after pressing the [START/STOP] button.

### 1 Turn the [STOP TIME] knob.

Turn clockwise: Increases the time taken to stop playback.

Turn counterclockwise: Decreases the time taken to stop playback.

---

---

## Beat Sync

If you turn Beat Sync on, BPM and the beat position of tracks on the Deck 1 and Deck 2 automatically synchronize.

- Beat Sync can't be used with tracks that haven't been analyzed by Serato DJ Pro.

### 1 Play a track that has been analyzed by Serato DJ Pro on the Deck 1 or Deck 2.

### 2 Press the [SYNC] button on the deck to sync a track with the track playing on another deck.

Beat Sync turns on.

- Press the [SYNC] button while pressing the [SHIFT] button to turn Beat Sync off.

---

## Key Sync

If you turn on Key Sync, the keys of tracks on Deck 1 and Deck 2 are automatically matched.

- You can't adjust the key for tracks that haven't been analyzed by Serato DJ Pro.

- 1 Play a track that has been analyzed by Serato DJ Pro on Deck 1 or Deck 2.**
- 2 While pressing the [SHIFT] button, press the [KEY -] button on the deck to match the key of the track with the one playing on the other deck.**

Key Sync turns on.

The key is adjusted to the key with the least change among the following.

- Same key
  - Dominant key
  - Subdominant key
  - Relative key
  - Relative key of dominant key
  - Relative key of subdominant key
- Press the [KEY +] button while pressing the [SHIFT] button to reset to the original key.

---

---

# Looping

You can choose a section of a track to play repeatedly.

---

---

## Loop section

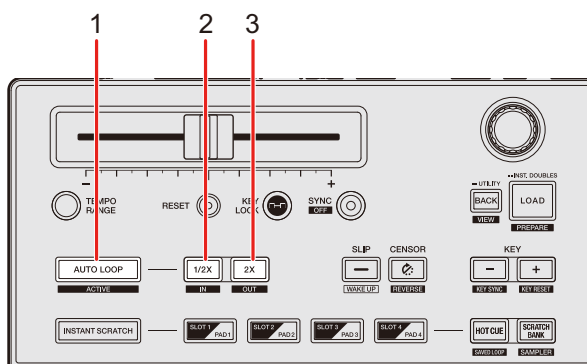

### 1. **AUTO LOOP** button

Plays a loop of the specified number of beats or starts Auto Beat Loop.

Press while pressing the [**SHIFT**] button to turn a loop on and off.

- You can choose whether the [**AUTO LOOP**] button starts a loop of the specified number of beats or starts Auto Beat Loop in [**LOOP options.**] ([**PREFERENCE**] tab) in Setting Utility (page 28).

### 2. **1/2X** button

Halves the length of the loop.

Press while pressing the [**SHIFT**] button during playback to set a loop-in point.

### 3. **2X** button

Doubles the length of the loop.

Press while pressing the [**SHIFT**] button during playback to set a loop-out point.

---

---

## Using a loop

---

---

### Setting a loop automatically

- 1 Press the [AUTO LOOP] button during playback.

Loop playback starts from the position where the button is pressed.

---

---

### Setting a loop manually

- 1 Press the [SHIFT] and [1/2X] buttons at the point where you want to start the loop (loop-in point) during playback.
- 2 Press the [SHIFT] and [2X] buttons at the point where you want the loop to end (loop-out point).

Loop playback of the specified section starts.

---

---

### Halving the length of a loop

- 1 Press the [1/2X] button during loop playback.

The loop length is halved each time you press the button.

---

---

### Doubling the length of a loop

- 1 Press the [2X] button during loop playback.

The loop length is doubled each time you press the button.

---

## Fine-adjusting loop points

### 1 Press the [1/2X] or [2X] button while pressing the [SHIFT] button during loop playback.

The unit switches to loop adjusting mode.

- [1/2X]: Adjusts the loop-in point.
- [2X]: Adjusts the loop-out point.

### 2 Turn the jog wheel to fine-adjust the loop point.

- Press the [1/2X] or [2X] button again, or leave the unit without operating the controls for more than 10 seconds to resume loop playback.



---

---

# Using Performance Pads and Deck Pads

You can use Performance Pads mode and Deck Pads mode at the same time.

- You can't use the modes on decks that have Instant Scratch turned on.

---

---

## Performance Pads section

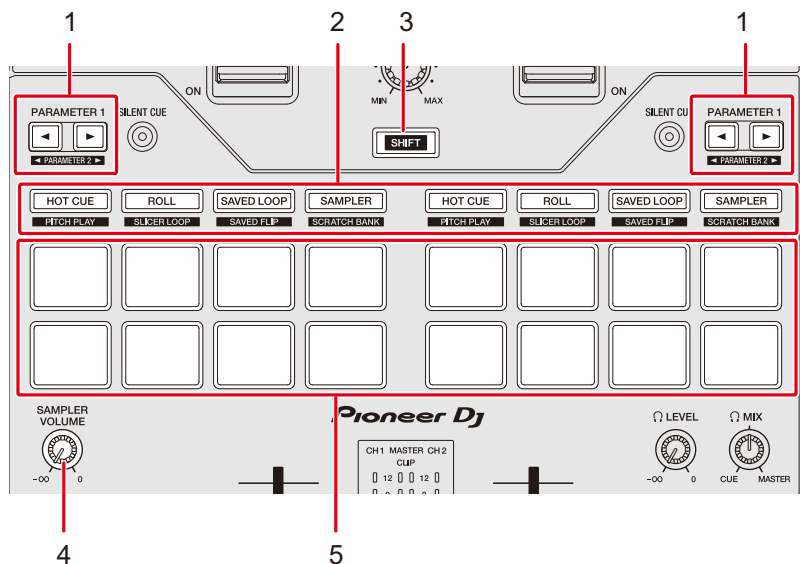

1. **PARAMETER 1 ◀, PARAMETER 1 ▶ buttons**

Sets the parameters.

2. **Pad mode buttons**

3. **SHIFT button**

Press a pad mode button while pressing the [SHIFT] button to call up another function assigned to the button.

4. **SAMPLER VOLUME knob**

Adjusts the sampler volume.

5. **Performance Pads**

## Hot Cue mode

You can call up a Hot Cue quickly and start playback by pressing a Performance Pad.

- You can set up to 8 Hot Cues per track.
- You can also use the Deck Pads ([**SLOT/PAD 1, 2, 3, 4**] buttons) to control Hot Cues (page 60).

### 1 Press the [**HOT CUE**] button.

The unit switches to Hot Cue mode.

### 2 Press a Performance Pad at the point where you want to set a Hot Cue during playback or pause.

A Hot Cue is set.

- Hot Cues are assigned to Performance Pads as follows.

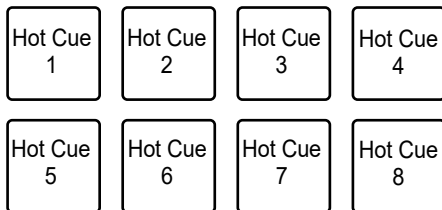

### 3 Press one of the Performance Pads that have a Hot Cue set.

Playback starts from the Hot Cue point.

- Press a Performance Pad while pressing the [**SHIFT**] button to clear a Hot Cue point set to the pad.

---

## Roll mode

Loop Roll playback continues according to the number of beats assigned to a Performance Pad while you press the pad.

### 1 Press the [ROLL] button.

The unit switches to Roll mode.

### 2 Press the [PARAMETER 1 ◀] or [PARAMETER 1 ▶] button.

The numbers of beats assigned to Performance Pads change as follows each time the button is pressed:

- 1/32 to 4 beats
- 1/16 to 8 beats
- 1/8 to 16 beats
- 1/4 to 32 beats

Example: When set to 1/8 to 16 beats, the numbers of beats are assigned to the Performance Pads as follows:

1/8	1/4	1/2	1
2	4	8	16

The numbers of beats are displayed on the Serato DJ Pro screen.



### 3 Press the Performance Pad assigned with the number of beats you want to play in a loop.

Loop Roll playback continues according to the number of beats assigned to the Performance Pad until you release the pad.

- Press the [1/2X] or [2X] button during Loop Roll playback to change the number of beats in the Loop Roll being played.

# Using Performance Pads and Deck Pads

- Normal playback continues with its original rhythm in the background during Loop Roll playback, but you can't hear this.
- Release the Performance Pad to end the Loop Roll playback. Normal playback starts from the exact point the track would have reached by then.

---

---

## Saved Loop mode

You can save a loop to a loop slot in Serato DJ Pro and call up the saved loop.

- You can also use the Deck Pads ([**SLOT/PAD 1, 2, 3, 4**] buttons) to control Saved Loop mode (page 62).

### 1 Press the [**SAVED LOOP**] button.

The unit switches to Saved Loop mode.

### 2 Press a Performance Pad during loop playback.

- Loops are assigned to the loop slots in Serato DJ Pro as follows:

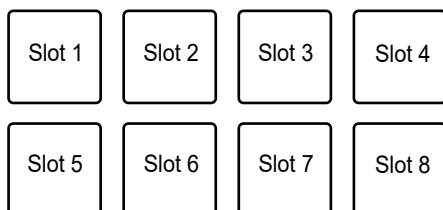

### 3 Press a Performance Pad assigned with a loop while pressing the [**SHIFT**] button.

Loop playback starts from the beginning of the loop.

- Press the [**PARAMETER 1 ◀**] or [**PARAMETER 1 ▶**] button during loop playback to change the length of the loop being played. The setting of the called-up loop is overwritten with the changed setting.
- Press the [**1/2X**] or [**2X**] button while pressing the [**SHIFT**] button during loop playback to move a loop without changing the loop length. The setting of the called-up loop is overwritten with the changed setting.
- Press the Performance Pad again to cancel loop playback.

---

## Sampler mode

You can start playback of a track loaded in a Sampler slot using a Performance Pad.

- You can also use the Deck Pads ([**SLOT/PAD 1, 2, 3, 4**] buttons) to control Sampler mode (page 63).

**1 Display the [SAMPLER] pane on the Serato DJ Pro screen.**

**2 Press the [SAMPLER] button on the unit.**

The unit switches to Sampler mode.

**3 Press the [PARAMETER 1 ◀] or [PARAMETER 1 ▶] button to switch Sampler Banks.**

There are 4 banks (A, B, C, D) to switch between.

- Each bank has 8 slots.

**4 Drag and drop a track to each slot on the [SAMPLER] pane to load it on the Serato DJ Pro screen.**

The Sampler settings and the loaded tracks are saved.

**5 Press the Performance Pad matching the slot (track) you want to play.**

Slot playback starts.

- Slots are assigned to Performance Pads as follows:

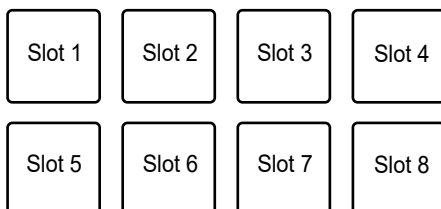

**6 Turn the [SAMPLER VOLUME] knob to adjust the volume of the Sampler sound.**

# Using Performance Pads and Deck Pads

- Playback methods differ according to the Sampler mode set in Serato DJ Pro. For details, refer to the Serato DJ Pro software manual (page 7).
- Press the Performance Pad while pressing the [**SHIFT**] button to stop slot playback.

---

---

## Pitch Play mode

Pitch Play is a function of Pitch 'n Time DJ.

- To use Pitch 'n Time DJ, activate the supplied license first (page 11).

### 1 Press the [**HOT CUE**] button while pressing the [**SHIFT**] button.

The unit switches to Pitch Play mode.

### 2 Press a Performance Pad while pressing the [**SHIFT**] button.

A Hot Cue assigned to the Performance Pad is selected.

### 3 Press a Performance Pad.

Playback starts from the selected Hot Cue point according to the pitch assigned to the Performance Pad.

- Press the [**PARAMETER 1 ◀**] or [**PARAMETER 1 ▶**] button during Pitch playback to change the pitch range. Each press switches between Up range, Middle range, and Down range.

#### — Up range:

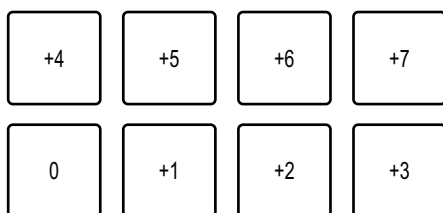

#### — Middle range:

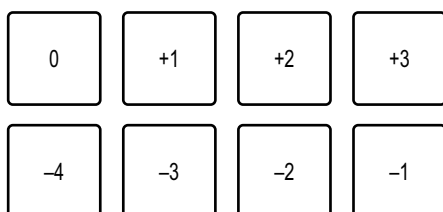

# Using Performance Pads and Deck Pads

## — Down range:

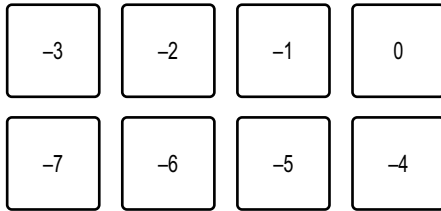

- Press the [**PARAMETER 1 ◀**] or [**PARAMETER 1 ▶**] button while pressing the [**SHIFT**] button to shift the pitch range by a semitone.

---

---

## Slicer Loop mode

A specified range is applied to the track and divided into 8 sections. The divided sections are assigned to different Performance Pads.

Loop playback of the section assigned to a Performance Pad continues while you press the Performance Pad.

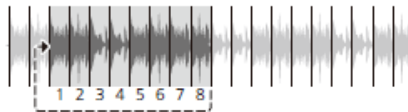

- You can't use Slicer Loop with a track that doesn't have beatgrid set. For details on how to set beatgrid, refer to the Serato DJ Pro software manual (page 7).

### 1 Press the [**ROLL**] button while pressing the [**SHIFT**] button.

The unit switches to Slicer Loop mode.

### 2 Press the [**PARAMETER 1 ◀**] or [**PARAMETER 1 ▶**] button while pressing the [**SHIFT**] button to specify the range (**DOMAIN**) to divide into 8 sections.

- Each press of the button sets the domain as follows from the position where the button is pressed:
  - 2 beats
  - 4 beats
  - 8 beats
  - 16 beats

# Using Performance Pads and Deck Pads

- 32 beats
- 64 beats
- The 8 sections of a divided domain are assigned to Performance Pads as follows:

## Sections 1 to 8:

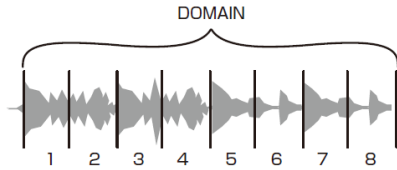

## Performance Pad assignment:

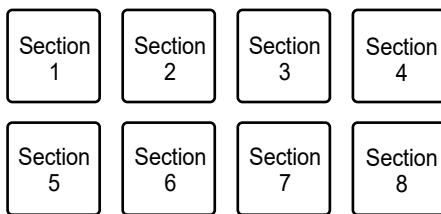

### 3 Press the [PARAMETER 1 ◀] or [PARAMETER 1 ▶] button to set Quantization.

Each press of the button sets Quantization as follows:

- 1/8 (plays a loop of 1/8 length from the beginning of a section)
- 1/4 (plays a loop of 1/4 length from the beginning of a section)
- 1/2 (plays a loop of 1/2 length from the beginning of a section)
- 1 (plays the entire section)

### 4 Press a Performance Pad assigned with the section you want to play in a loop.

Loop playback continues until you release the Performance Pad.

- Normal playback continues with its original rhythm in the background during Slicer Loop playback, but you can't hear this.
- Release a Performance Pad to end Slicer Loop playback. Normal playback starts from the exact point the track would have reached by then.
- Playback returns to and continues from the beginning of section 1 if playback reaches the end of the domain.



# Using Performance Pads and Deck Pads

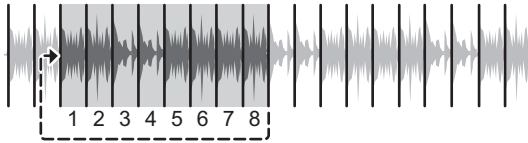

- Press the [ROLL], [HOT CUE], or [SAMPLER] button to cancel Slicer Loop mode.

---

## Saved Flip mode

Serato Flip is a function that enables you to record a sequence, or call up a recorded sequence, of Hot Cues. The recorded sequence of Hot Cues is called a Flip.

You can save and play a Flip using Performance Pads on the unit.

- To use Saved Flip mode, you need to buy and activate Serato Flip. For details, visit the URL below.

[serato.com](http://serato.com)

---

## Registering a Flip to a slot

### 1 Create a Flip using Serato DJ Pro.

- For details on how to create a Flip, refer to the Serato DJ Pro software manual (page 7).

### 2 Press the [SAVED LOOP] button while pressing the [SHIFT] button.

The unit switches to Saved Flip mode.

### 3 Press the Performance Pad for the slot you want to save the Flip to.

The Flip is saved to the slot.

# Using Performance Pads and Deck Pads

- Slots are assigned to Performance Pads as follows:

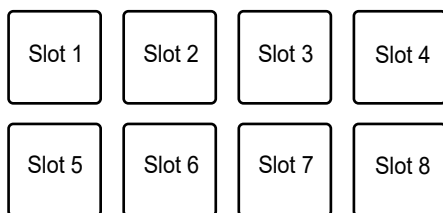

- You can't save a Flip to a slot if all slots have saved Flips already. Delete a Flip on the slot screen in Serato DJ Pro to free up a slot for a new Flip.

---

## Calling up and playing a Flip

### 1 Press the **[SAVED LOOP]** button while pressing the **[SHIFT]** button.

The unit switches to Saved Flip mode.

### 2 Press the Performance Pad assigned with the slot (Flip) you want to play.

The Flip is called up and playback starts from the beginning of the Flip.

- Slots are assigned to Performance Pads as follows:

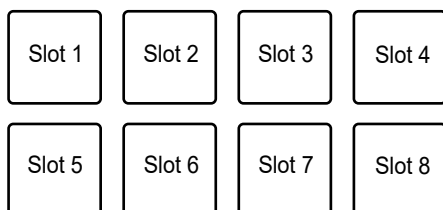

- If you call up a Flip by pressing a Performance Pad while pressing the **[SHIFT]** button, playback doesn't start from the beginning. Instead, Flip playback starts when the playback of the track reaches the beginning of the Flip.
- Press a Performance Pad during Flip playback to move to the beginning of the Flip that's playing.
- Press the Performance Pad while pressing the **[SHIFT]** button to cancel Flip playback and return to normal playback.

## Scratch Bank mode

You can load sound of a Scratch Bank.

- You can also use the Deck Pads ([**SLOT/PAD 1, 2, 3, 4**] buttons) to control Scratch Bank mode (page 61).

**1 Open the [**SCRATCH BANK**] pane on the Serato DJ Pro screen.**

**2 Press the [**SAMPLER**] button while pressing the [**SHIFT**] button.**

The unit switches to Scratch Bank mode.

**3 Press the Performance Pad assigned with the Scratch Bank you want to load.**

Sound of the Scratch Bank are loaded to the unit.

- Slots are assigned to Performance Pads as follows:

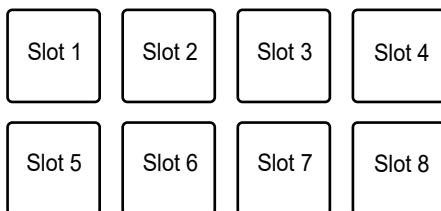

- Press a Performance Pad while pressing the [**SHIFT**] button to load the last loaded track.

## Deck Pads section

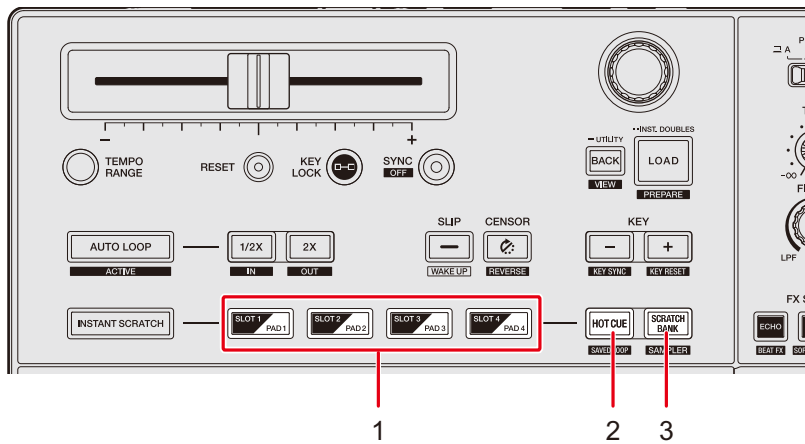

1. **SLOT/PAD 1, 2, 3, 4 buttons**
2. **HOT CUE button**
3. **SCRATCH BANK button**

## Hot Cue mode

You can call up a Hot Cue quickly and start playback by pressing the **[SLOT/PAD 1, 2, 3, 4]** buttons.

- You can set up to 8 Hot Cues per track.
- You can also use the Performance Pads to control Hot Cues (page 50).

### 1 Press the **[HOT CUE]** button.

The unit switches to Hot Cue mode.

### 2 Press one of the **[SLOT/PAD]** buttons at the point where you want to set a Hot Cue during playback or pause.

A Hot Cue is set.

- Hot Cues are assigned to the **[SLOT/PAD]** buttons as follows.

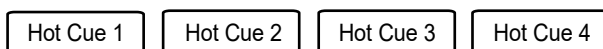

# Using Performance Pads and Deck Pads

## 3 Press one of the [SLOT/PAD] buttons that have a Hot Cue set.

Playback starts from the Hot Cue point.

- Press one of the [SLOT/PAD] buttons while pressing the [SHIFT] button to clear a Hot Cue point set to the button.

---

---

## Scratch Bank mode

You can load sound of a Scratch Bank.

- You can also use the Performance Pads to control Scratch Bank (page 59).

## 1 Open the [SCRATCH BANK] pane on the Serato DJ Pro screen.

## 2 Press the [SCRATCH BANK] button.

The unit switches to Scratch Bank mode.

## 3 Press one of the [SLOT/PAD] buttons assigned with the Scratch Bank you want to load.

Sound of the Scratch Bank is loaded to the unit.

- Slots are assigned to the [SLOT/PAD] buttons as follows:



- Press one of the [SLOT/PAD] buttons while pressing the [SHIFT] button to load the last loaded track.

## Saved Loop mode

You can save a loop to a loop slot in Serato DJ Pro and call up the saved loop.

- You can also use the Performance Pads to control Saved Loop mode (page 52).

### 1 Press the [HOT CUE] button while pressing the [SHIFT] button.

The unit switches to Saved Loop mode.

### 2 Press one of the [SLOT/PAD] buttons during loop playback.

Loops are assigned to the loop slots in Serato DJ Pro as follows:



### 3 Press one of the [SLOT/PAD] buttons assigned with a loop while pressing the [SHIFT] button.

Loop playback starts from the beginning of the loop.

- Press the [SLOT/PAD] button again to cancel loop playback.

## Sampler mode

You can start playback of a track loaded in a Sampler slot using [SLOT/PAD 1, 2, 3, 4] buttons.

- You can also use the Performance Pads to control Sampler mode (page 53).

**1 Display the [SAMPLER] pane on the Serato DJ Pro screen.**

**2 Press the [SCRATCH BANK] button while pressing the [SHIFT] button on the unit.**

The unit switches to Sampler mode.

**3 Drag and drop a track to each slot on the [SAMPLER] pane to load it on the Serato DJ Pro screen.**

The Sampler settings and the loaded tracks are saved.

**4 Press one of the [SLOT/PAD] buttons matching the slot (track) you want to play.**

Slot playback starts.

- Slots are assigned to Performance Pads as follows:



**5 Turn the [SAMPLER VOLUME] knob to adjust the volume of the Sampler sound.**

- Playback methods differ according to the Sampler mode set in Serato DJ Pro. For details, refer to the Serato DJ Pro software manual (page 7).
- Press one of the [SLOT/PAD] buttons while pressing the [SHIFT] button to stop slot playback.

---

---

# Slip

If you turn Slip mode on, normal playback continues in the background (but you can't hear it) when you perform the following operations.

When you end the operation, Slip is canceled and normal playback starts from the exact point the track would have reached by then. This means the original rhythm remains constant and your performance stays perfectly in time.

Function	Description
Slip Pause	If you press the <b>[START/STOP]</b> button during playback, playback continues in the background during the pause.
Slip Braking	If you press the <b>[START/STOP]</b> button during playback, playback stops according to the time (until playback stops) set with the <b>[STOP TIME]</b> knob (page 44). Playback continues unheard in the background during the pause.
Slip Scratch	If you scratch a track using the jog wheel, normal playback continues in the background while you are scratching.
Slip Loop	If you start loop playback (page 47), normal playback continues in the background while the loop is playing.
Slip Reverse	If you press the <b>[CENSOR </b> ] button during playback, playback is reversed (page 42). Normal playback continues in the background during reverse playback.
Slip Hot Cue	If you press a Performance Pad (page 50) or <b>[SLOT/PAD]</b> button (page 60) with a Hot Cue set during playback, the playback point jumps to the Hot Cue point and playback continues until you release the pad/button. Normal playback continues in the background during Hot Cue playback.



---

## Turning Slip mode on

### 1 Press the [SLIP] button.

Slip mode turns on and the [SLIP] button lights up.

- The [SLIP] button blinks while Slip is in use.
- Press the [SLIP] button again or load a track to turn Slip mode off.

---

---

# Instant Scratch

The unit has 4 scratch sounds that you can play at the touch of a button.

You can instantly call up the scratch sounds with the **[SLOT / PAD 1, 2, 3, 4]** buttons.

- Some functions are fixed as follows when the unit is in Instant Scratch mode.
  - Tempo range:  $\pm 8\%$
  - Key Lock: Turned off
  - Sync: Turned off
  - Slip: Turned off
  - Censor: Turned off
  - Reverse: Turned off
  - Loop: Loop playback
  - Key: Original key
  - Performance Pads: FX Trigger mode
  - Deck Pads: Not available
  - Silent Cue: Turned off
  - Smooth Echo: Turned off

---

---

## Instant Scratch section

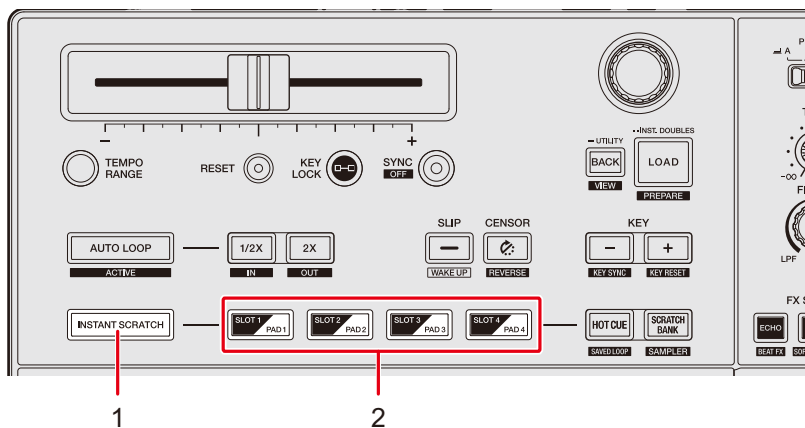

### 1. INSTANT SCRATCH button

Turns Instant Scratch mode on and off. The button lights up when it's turned on.

### 2. SLOT/PAD 1, 2, 3, 4 buttons

---

## Using Instant Scratch

**1 Set the input selector switch to [A] or [B].**

**2 Press the [INSTANT SCRATCH] button.**

The unit switches to Instant Scratch mode.

**3 Press one of the [SLOT/PAD] buttons.**

The corresponding scratch sound is loaded to the deck.

**4 Press the [START/STOP] button.**

Loop playback of the scratch sound starts.

- If you press the [SLOT/PAD] button (step 3) while the deck is playing, the scratch sound starts playing automatically in a loop when it's loaded to the deck.
  - Press another [SLOT/PAD] button to change scratch sound.
- 
- Press the [INSTANT SCRATCH] button again to turn Instant Scratch mode off.

---

---

# Audio output

Follow the procedures below to output and adjust sound.

- Outputting sound (page 70)
- Adjusting the sound (page 71)
- Setting the faders (page 71)

🔊 To output sound to the [BOOTH] terminals, see Using a booth monitor (page 76).

---

---

## Channel section/master section

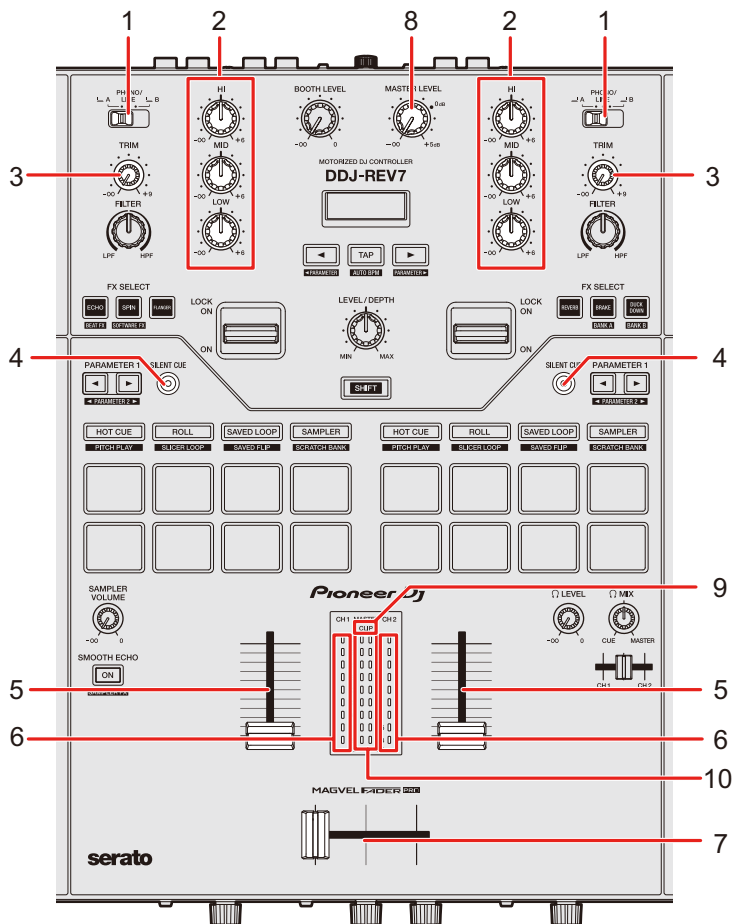

## ❖ Channel section

### 1. Input selector switch

Selects an input sound source.

- **[A, B]**: Selects a PC/Mac connected to the **[USB]** terminal.
- **[PHONO/LINE]**: Selects a turntable or DJ player, etc. connected to the **[CH 1]** or **[CH 2]** terminals.

### 2. HI, MID, LOW knobs

Adjusts the volume (ISO) of each frequency band.

Each knob adjusts in the following range.

- **[HI]**:  $-\infty$  dB to +6 dB
- **[MID]**:  $-\infty$  dB to +6 dB
- **[LOW]**:  $-\infty$  dB to +6 dB

### 3. TRIM knob

Adjusts the volume for the channel input sound.

### 4. SILENT CUE button

Mutes the sound of a track playing in the deck.

### 5. Channel fader

Adjusts the volume for the channel output sound according to the channel fader curve set with the **[CH 1 CURVE]** or **[CH 2 CURVE]** knob (page 72). Moving it up increases the volume, and down decreases the volume.

### 6. Channel level indicator

Displays the volume level before the sound passes through the channel fader.

### 7. Crossfader

Adjusts the volume balance between the channel output sounds according to the crossfader curve specified with the **[CURVE]** knob (page 73). Moving it to the Deck 1 (left) side outputs the sound of Deck 1, and to the Deck 2 (right) side outputs the sound of Deck 2.

## ❖ Master section

### 8. MASTER LEVEL knob

Adjusts the volume for the master sound.

### 9. CLIP indicator

Blinks when excessive volume is output from the **[MASTER 1]** or **[MASTER 2]** terminals.

## 10. Master level indicator

Displays the volume level of the master sound output to the [MASTER 1] and [MASTER 2] terminals.

---

---

## Outputting sound

---

### Adjusting the channel input volume

- 1 Slide the input selector switch to select an input sound source.
- 2 Turn the [TRIM] knob to adjust the volume for the input sound.

The channel level indicator lights up when sound is input to the channel.

---

### Adjusting the channel output volume

- 1 Move the channel fader to adjust the volume for the output sound.
- 2 Move the crossfader to adjust the volume balance of the two channels.

- Press the [SILENT CUE] button to mute the sound of the track playing on the deck. Press the button again to cancel the mute.

You can also cancel the mute by playing a Hot Cue.

---

## Adjusting the master sound volume

- 1 Turn the [MASTER LEVEL] knob to adjust the volume for the master sound.

The master level indicator lights up when the master sound is output.

- When outputting sound from the speakers of a PC/Mac, adjust the volume of the speakers.

---

---

## Adjusting the sound

- 1 Turn the [HI, MID, LOW] knobs to adjust the volume of each band.

---

---

## Setting the faders



Set the channel fader and crossfader.

---

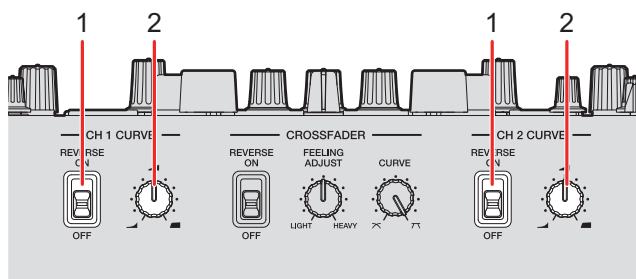
## CH Curve section



1. **REVERSE switch**  
Turns the channel fader reverse function on and off.
2. **CH 1/2 CURVE knob**  
Sets the channel fader curve.

- : Steeply raises the volume when the channel fader is moved close to the top position.
- : Gradually raises the volume as the channel fader is moved up.
- : Steeply raises the volume as the channel fader is moved from the bottom position.

---

## Setting the channel fader

### 1 Turn the [CH 1/2 CURVE] knob to set the channel fader curve.

- Set the [REVERSE] switch to [ON] to reverse the operating direction of the channel fader.

---

## Crossfader section

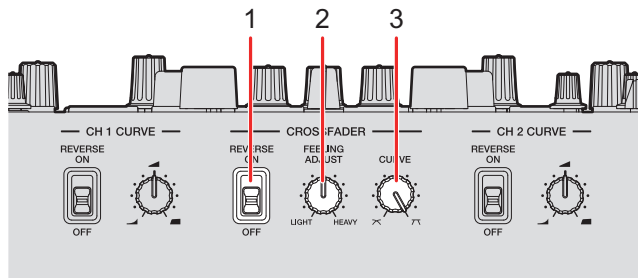

#### 1. REVERSE switch



Turns the crossfader reverse function on and off.

#### 2. FEELING ADJUST knob

Adjusts the “weight” of the crossfader.

#### 3. CURVE knob

Sets the crossfader curve.

- : Gradually raises the volume of the sound assigned to the other side as the crossfader is moved from one side (CH 1 or CH 2 side) to the other, and decreases the volume of the sound on the side it's moving away from.
- : Steeply raises the volume of the sound assigned to the other side as the crossfader is moved from one side (CH 1 or CH 2 side) to the other.



## Setting the crossfader

- 1 Turn the [CURVE] knob to set the crossfader curve.
  - 2 Turn the [FEELING ADJUST] knob to adjust the “weight” of the crossfader.
- Set the [REVERSE] switch to [ON] to reverse the operating direction of the crossfader.

---

---



# Monitoring sound

---

---

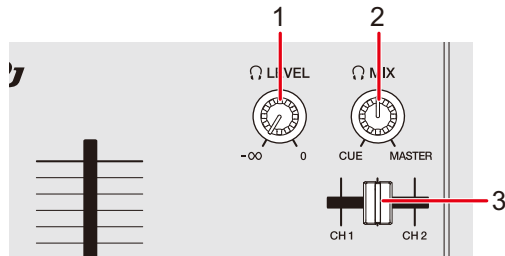
## Headphones section



1.  **LEVEL knob**  
Adjusts the volume for sound output from the [**PHONES**] terminals.
2.  **MIX knob**  
Adjusts the volume balance between the master sound and the channel selected with the headphones cue fader.
  - Set the knob to [**CUE**] to monitor only the channel sound, and to [**MASTER**] to monitor only the master sound.
3. **Headphones cue fader**  
Adjusts the volume balance between the CH 1 sound and CH 2 sound output to the headphones.

---

## Monitoring with headphones

### 1 Connect headphones to one of the [PHONES] terminals.

📖 Read more: Front panel (page 13)

### 2 Turn the [🎧 MIX] knob to adjust the volume balance between the channel sound and the master sound.

### 3 Move the headphones cue fader to adjust the volume balance between the CH 1 sound and the CH 2 sound.

### 4 Turn the [🎧 LEVEL] knob to adjust the volume.

---

## Booth section

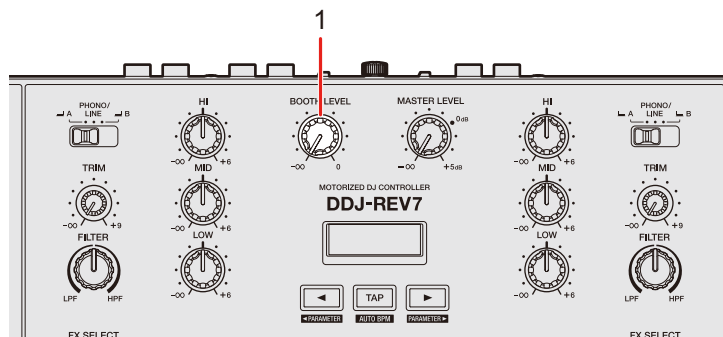

### 1. **BOOTH LEVEL knob**

Adjusts the volume for the sound output to a booth monitor.

## Using a booth monitor

**1 Connect a booth monitor to the [BOOTH] terminals.**

 Read more: Rear panel (page 13)

**2 Turn the [BOOTH LEVEL] knob to adjust the volume for the output sound.**

---

---

# Microphone

---

---

## MIC section

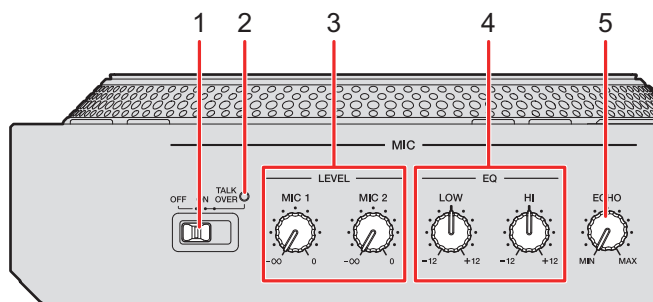

### 1. OFF, ON, TALKOVER selector switch

Sets the microphone sound output.

- **[OFF]**: Turns the microphone off.
- **[ON]**: Turns the microphone on.
- **[TALKOVER]**: Turns microphone talkover on. When sound of -10 dB or more is input to the microphone, the volume other than the microphone channel is attenuated by -18 dB.

- You can change the talkover mode setting and attenuation level in **[TALKOVER MODE]** and **[TALKOVER LEVEL]** in the Utility settings (page 99).

### 2. MIC indicator

Indicates the microphone sound output as follows.

- Off: The microphone is off.
- Lights up: The microphone is on.
- Blinks: The microphone talkover is on.

### 3. LEVEL (MIC 1, MIC 2) knobs

Adjusts the volume of sound input from the **[MIC 1]** and **[MIC 2]** terminals.

### 4. EQ (HI, LOW) knobs

Adjusts the volume of sound input from the **[MIC 1]** and **[MIC 2]** terminals. Each knob adjusts in the following range.

- **[HI]**: -12 dB to +12 dB (10 kHz)
- **[LOW]**: -12 dB to +12 dB (100 kHz)

## 5. **ECHO knob**

Turns the microphone echo on and off.

---

---

## Using a microphone

### 1 **Connect a microphone to the [MIC 1] or [MIC 2] terminal.**

- Microphone gain varies depending on the microphone you use. Before DJ, adjust the sound level according to your microphone with the **[ATT.]** knob on the rear of the unit.

 Read more: Rear panel (page 13)

### 2 **Slide the [OFF, ON, TALKOVER] selector switch to set the microphone sound output.**

### 3 **Turn the [LEVEL MIC 1] or [LEVEL MIC 2] knob to adjust the microphone volume level.**

- Note that turning the knob too far clockwise outputs the sound at a high volume.

### 4 **Turn the [EQ (HI, LOW)] knob to adjust the volume of each band.**

### 5 **Speak into the microphone.**

---

---

## Using the microphone echo

### 1 **Turn the [ECHO] knob.**

Echo is applied to the microphone sound.

---

---

# External input

If you connect a DJ player or turntable to the external input terminals on the unit, you can mix the sounds of the external inputs without using a PC/Mac.

---

---

## Mixing sounds of external inputs

- 1 Connect an external device to the [CH 1] or [CH 2] terminals.**
  - Read more: Rear panel (page 13), Connecting to the input terminals (page 31)
- 2 Set the [LINE/PHONO] selector switch to [LINE] or [PHONO].**
  - Set to [LINE] when you connect a line-level output device such as a DJ player.
  - Set to [PHONO] when you connect a phono-level (MM cartridge) output device such as a turntable.
- 3 Set the input selector switch to [PHONO/LINE].**
- 4 Turn the [TRIM] knob to adjust the input sound volume.**
- 5 Move the channel fader to adjust the output sound volume.**

---

## Using AUX

---

---

### AUX section

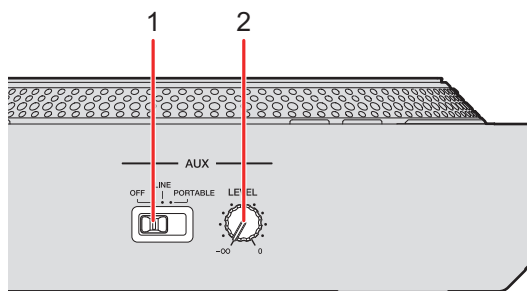

#### 1. AUX (OFF, LINE, PORTABLE) switch

- [OFF]: Mutes the input sound.
- [LINE]: Sound is input from devices other than a mobile device.
- [PORTABLE]: Sound is input from a mobile device.

#### 2. LEVEL knob

Adjusts the volume for the input sound of the AUX channel.

---

## Using AUX

### 1 Connect an external device to the [AUX] terminals.

➡ Read more: Rear panel (page 13), Connecting to the input terminals (page 31)

### 2 Slide the [AUX (OFF, LINE, PORTABLE)] switch to select an external device to use.

### 3 Turn the [LEVEL] knob to adjust the volume of the input sound.



---

---

# Filter

You can apply a filter or an effect to the sound on any channel.

---

---

## Filter section

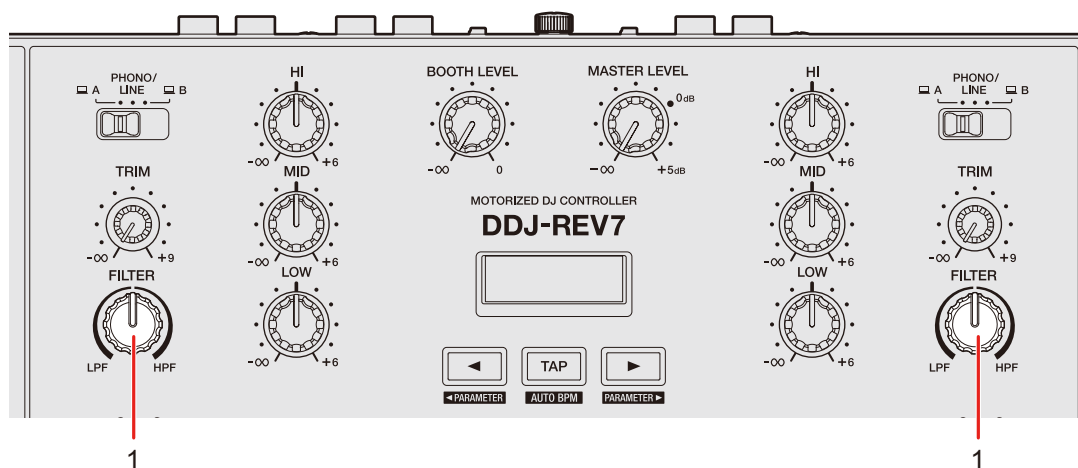

### 1. FILTER knob

Adjusts a filter or an effect.

---

---

## Using a filter or an effect

You can choose which effect is assigned to the [FILTER] knobs. Choose an effect from the [FILTER] pull-down list on the [FX BANK] tab in Setting Utility (page 26).

## Effect types and settings

You can adjust the following settings with the **[FILTER]** knobs or from the **[FX BANK]** tab in Setting Utility.

Effect/operation	Description
<b>FILTER</b>	Outputs filtered sound.
<ul style="list-style-type: none"> <li>• <b>FILTER:</b></li> </ul>	<p>Turn counterclockwise to lower the cut-off frequency of the low-pass filter.</p> <p>Turn clockwise to raise the cut-off frequency of the high-pass filter.</p>
<ul style="list-style-type: none"> <li>• <b>Sub parameter:</b></li> </ul>	Resonance
<b>DUB ECHO</b>	Adds reverberating echo by outputting the sounds slightly delayed from the original sound several times and attenuating them.
<ul style="list-style-type: none"> <li>• <b>FILTER:</b></li> </ul>	<p>Turn counterclockwise to add reverberating echo to the middle frequency range.</p> <p>Turn clockwise to add reverberating echo to the high frequency range.</p>
<ul style="list-style-type: none"> <li>• <b>Sub parameter:</b></li> </ul>	Feedback
<b>NOISE</b>	Outputs filtered white noise mixed with the sound of the channel.
<ul style="list-style-type: none"> <li>• <b>FILTER:</b></li> </ul>	<p>Turn counterclockwise to lower the cut-off frequency for the filter which passes white noise through.</p> <p>Turn clockwise to raise the cut-off frequency for the filter which passes white noise through.</p>
<ul style="list-style-type: none"> <li>• <b>Sub parameter:</b></li> </ul>	Volume of the noise

Effect/operation	Description
<b>PITCH</b>	Changes the pitch.
<ul style="list-style-type: none"><li>• <b>FILTER:</b></li></ul>	Turn counterclockwise to lower the pitch. Turn clockwise to raise the pitch.
<ul style="list-style-type: none"><li>• <b>Sub parameter:</b></li></ul>	Pitch change range: $\pm 1$ semitone to $\pm 2$ octaves
<hr/>	
<b>WIDE FILTER</b>	Outputs filtered sound.
<ul style="list-style-type: none"><li>• <b>FILTER:</b></li></ul>	Turn counterclockwise to lower the cut-off frequency for the low-pass filter. Turn clockwise to raise the cut-off frequency for the high-pass filter. Turn all the way counterclockwise or clockwise to completely cut the sound.
<ul style="list-style-type: none"><li>• <b>Sub parameter:</b></li></ul>	Resonance
<hr/>	

---

---

# Beat FX/software effects

The unit has 6 buttons for effects. You can assign the internal effects (Beat FX) or DJ software effects to the buttons.

---

---

## Effects section

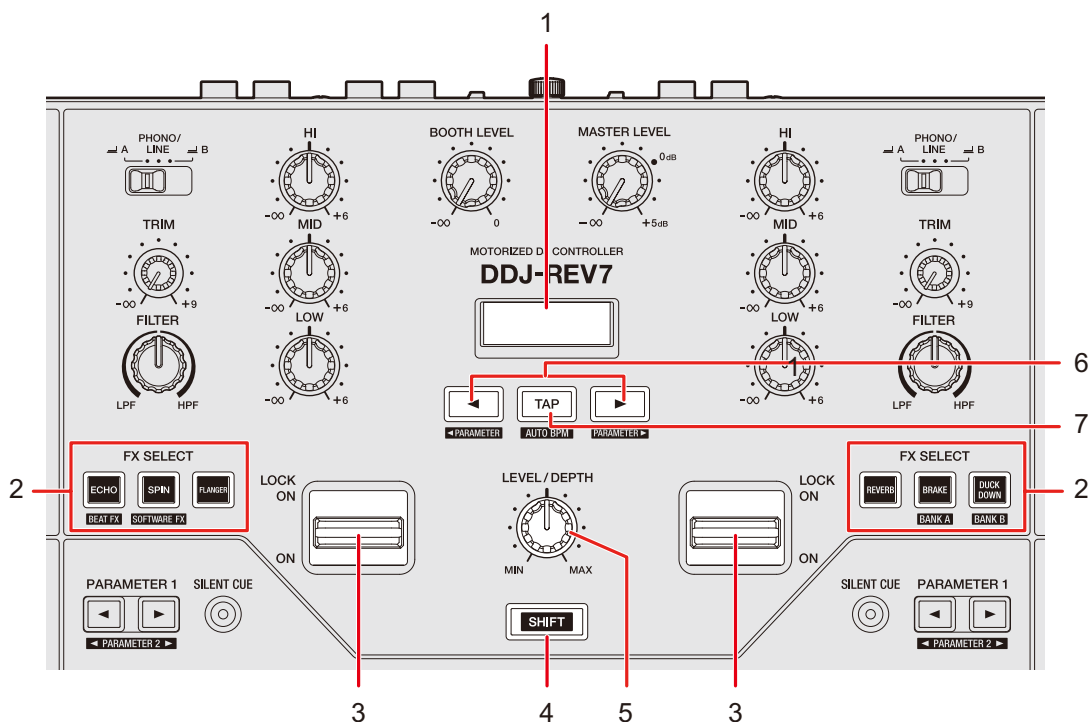

### 1. Effect section display

Displays the effect names, BPM, and parameters.

### 2. FX SELECT buttons

Select the internal effects (Beat FX) or DJ software effects.

### 3. Effect lever

Applies an effect.

- [ON]: Applies an effect while you hold the effect lever in the [ON] position. Release the lever to return it to the center position and turn the effect off.

- **[LOCK ON]**: Continues applying an effect when you let go of the effect lever and leave it in the **[LOCK ON]** position. Return the effect lever to the center position to turn the effect off.
- 4. **SHIFT button** (page 49)
- 5. **LEVEL/DEPTH knob**  
Adjusts the quantitative parameters for effects.
- 6. **◀/▶ button**  
Sets the number of beats for Beat FX.
- 7. **TAP button**  
Sets BPM.

---

---

## Effects section display

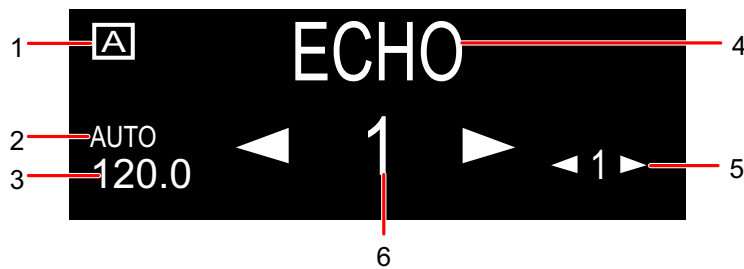

1. **FX Bank display**  
Displays the selected FX Bank when it's used.
2. **AUTO/TAP indicator**  
Displays **[AUTO]** when in Automatic BPM Measuring mode, and **[TAP]** when in Manual BPM Input mode.
3. **BPM**
  - BPM blinks when it can't be detected in Automatic BPM Measuring mode.
4. **Effect name**  
Displays the name of the selected effect.
5. **Sub parameter**  
Displays sub parameters for Beat FX.
6. **Beat/parameter**  
Displays the number of beats.  
For some effects, you can display parameters by pressing the **[◀]** or **[▶]** button.

---

## Using Beat FX/software effects

📖 Read more: Beat FX types and settings (page 87)

### 1 Press the [ECHO] or [SPIN] button while pressing the [SHIFT] button.

- To use Beat FX, press the [ECHO] button while pressing the [SHIFT] button.
- To use software effects, press the [SPIN] button while pressing the [SHIFT] button.

### 2 Press the [FX SELECT] button assigned with the effect you want to use.

- If you press multiple [FX SELECT] buttons with software effects assigned, you can use multiple software effects at the same time.
- You can use up to 6 effects at the same time by selecting an internal effect (one of the Beat FX) and multiple software effects (up to 5 effects).
- You can change effects assigned to the [FX SELECT] buttons (page 26).

### 3 Set BPM with the [TAP] button.

- Press the [TAP] button to manually set BPM.
- Press the [TAP] button while pressing the [SHIFT] button to automatically set BPM.

### 4 Press the [◀] or [▶] button to set a beat fraction to synchronize the effect with.

### 5 Turn the [LEVEL/DEPTH] knob to adjust the effect.

- Turn the knob all the way counterclockwise to output the original sound.

### 6 Set the effect lever to [ON] or [LOCK ON].

The selected effect is applied to the sound of the channel on which you're using the effect lever.

## Beat FX types and settings



You can adjust the following settings with the relevant buttons and knob or on the **[FX BANK]** tab in Setting Utility.





- Press the [◀] or [▶] button while pressing the **[SHIFT]** button to adjust the sub parameters.

Beat FX/operation	Description
<b>ECHO</b> <sup>1</sup>	Outputs a delay sound several times while attenuating it according to the beat.
<ul style="list-style-type: none"> <li>• ◀▶:</li> <li>• <b>LEVEL/DEPTH:</b></li> <li>• <b>Sub parameter:</b></li> </ul>	<p>Delay time with respect to 1 beat of the BPM (beat fraction): 1/32 to 16 beats</p> <p>Balance between the original sound and the effected sound, and feedback</p> <p>Cut-off frequency for HPF: 1 to 9</p>
<b>TIME SWEEP ECHO</b> <sup>1</sup>	Outputs an echo sound which increases the delay time to the time specified by the number of beats.
<ul style="list-style-type: none"> <li>• ◀▶:</li> <li>• <b>LEVEL/DEPTH:</b></li> <li>• <b>Sub parameter:</b></li> </ul>	<p>Delay time with respect to 1 beat of the BPM (beat fraction): 1/32 to 16 beats</p> <p>Balance between the original sound and the effected sound, and feedback</p> <p>RATE: 1 to 9</p>
<b>DUCKING ECHO</b> <sup>1</sup>	Outputs a delay sound several times while attenuating it when sound is muted by the crossfader or channel fader.
<ul style="list-style-type: none"> <li>• ◀▶:</li> <li>• <b>LEVEL/DEPTH:</b></li> <li>• <b>Sub parameter:</b></li> </ul>	<p>Delay time with respect to 1 beat of the BPM (beat fraction): 1/32 to 16 beats</p> <p>Balance between the original sound and the effected sound, and feedback</p> <p>Cut-off frequency for HPF: 1 to 9</p>



Beat FX/operation	Description
<b>ECHO OUT</b> <sup>1</sup>	Mutes the input sound and outputs a delay sound several times while attenuating it.
<ul style="list-style-type: none"> <li>• <b>◀/▶:</b> Delay time with respect to 1 beat of the BPM (beat fraction): 1/32 to 16 beats</li> <li>• <b>LEVEL/DEPTH:</b> Balance between the original sound and the effected sound, and feedback</li> <li>• <b>Sub parameter:</b> Cut-off frequency for HPF: 1 to 9</li> </ul>	
<b>FILL OUT</b> <sup>1</sup>	Mutes the input sound after outputting a Fill sound (Roll sound with rhythm changed) and outputs a delay sound several times while attenuating it.
<ul style="list-style-type: none"> <li>• <b>◀/▶:</b> Fill sound: 1 to 7, R (random)</li> <li>• <b>LEVEL/DEPTH:</b> Balance between the original sound and the effected sound, and mute amount</li> <li>• <b>Sub parameter:</b> Output number of the beats for Fill sound: 1, 2, 4</li> </ul>	
<b>SPIRAL</b> <sup>1</sup>	Adds reverberation to the input sound.
<ul style="list-style-type: none"> <li>• <b>◀/▶:</b> Delay time with respect to 1 beat of the BPM (beat fraction): 1/16 to 16 beats</li> <li>• <b>LEVEL/DEPTH:</b> Balance between the original sound and the effected sound, and feedback</li> <li>• <b>Sub parameter:</b> Speed: 1 to 9</li> </ul>	



Beat FX/operation	Description
<b>HELIX</b>	Records the input sound and outputs the recorded sound repeatedly according to the specified beat fraction.
<ul style="list-style-type: none"> <li>• : Effect time with respect to 1 beat of the BPM (beat fraction): 1/16 to 16 beats</li> <li>• <b>LEVEL/DEPTH</b>: Ratio of sound overlay <ul style="list-style-type: none"> <li>• You can change the attenuation rate by turning the <b>[LEVEL/DEPTH]</b> knob all the way counterclockwise and then clockwise. Turn the knob all the way clockwise to fix the output sound.</li> </ul> </li> <li>• <b>Sub parameter</b>: Speed: 1 to 9</li> </ul>	
<b>HELIX OUT</b>	Records the input sound and then outputs it repeatedly – like reverberation – while increasing the playback speed and the pitch.
<ul style="list-style-type: none"> <li>• : Effect time with respect to 1 beat of the BPM (beat fraction): 1/16 to 2 beats</li> <li>• <b>LEVEL/DEPTH</b>: Ratio of sound overlay <ul style="list-style-type: none"> <li>• You can change the attenuation rate by turning the <b>[LEVEL/DEPTH]</b> knob all the way counterclockwise and then clockwise. Turn the knob all the way clockwise to fix the output sound.</li> </ul> </li> <li>• <b>Sub parameter</b>: Fade-out time: 1 to 9</li> </ul>	
<b>DELAY</b> <sup>1</sup>	Outputs a delay sound once according to the beat.
<ul style="list-style-type: none"> <li>• : Delay time with respect to 1 beat of the BPM (beat fraction): 1/32 to 4 beats</li> <li>• <b>LEVEL/DEPTH</b>: Balance between the original sound and the effected sound</li> <li>• <b>Sub parameter</b>: Swing: 1 to 9</li> </ul>	

Beat FX/operation	Description
<b>REVERB</b> <sup>1</sup>	Adds reverberation to the input sound.
<ul style="list-style-type: none"> <li>• : Reverberation level: 1 to 100%</li> <li>• <b>LEVEL/DEPTH</b>: Balance between the original sound and the effected sound</li> <li>• <b>Sub parameter</b>: Cut-off frequency for HPF: 1 to 9</li> </ul>	
<b>ONE-SHOT SPIN</b>	Adds an effect of fast reversing the input sound being played.
<ul style="list-style-type: none"> <li>• : Reverse playback time with respect to 1 beat of the BPM (beat fraction): 1/16 to 64 beats</li> <li>• <b>LEVEL/DEPTH</b>: Balance between the original sound and the effected sound, and playback speed</li> <li>• <b>Sub parameter</b>: Brake speed: 1 to 9</li> </ul>	
<b>ONE-SHOT BRAKE</b>	Slows down the playback speed for the input sound gradually and then stops playback.
<ul style="list-style-type: none"> <li>• : Effect time with respect to 1 beat of the BPM (beat fraction): 1/16 to 64 beats</li> <li>• <b>LEVEL/DEPTH</b>: Balance between the original sound and the effected sound, and playback speed</li> <li>• <b>Sub parameter</b>: Spin speed: 1 to 9</li> </ul>	
<b>DUCK DOWN</b>	Outputs a Roll sound which fades out while lowering the pitch.
<ul style="list-style-type: none"> <li>• : Effect time with respect to 1 beat of the BPM (beat fraction): 1/16 to 2 beats, R (random)</li> <li>• <b>LEVEL/DEPTH</b>: Balance between the original sound and the effected sound, and mute amount</li> <li>• <b>Sub parameter</b>: Fade-out time: 1 to 9</li> </ul>	

Beat FX/operation	Description
<b>FLANGER</b>	Adds a cyclic flanger effect according to the beat.
<ul style="list-style-type: none"> <li>• ◀▶:</li> <li>• LEVEL/DEPTH:</li> <li>• Sub parameter:</li> </ul>	<p>Moving cycle of the effect with respect to 1 beat of the BPM (beat fraction): 1/16 to 64 beats</p> <p>Effect level</p> <p>Depth of flanger effect: 1 to 9</p>
<b>PHASER</b>	Adds a cyclic phaser effect according to the beat.
<ul style="list-style-type: none"> <li>• ◀▶:</li> <li>• LEVEL/DEPTH:</li> <li>• Sub parameter:</li> </ul>	<p>Moving cycle of the effect with respect to 1 beat of the BPM (beat fraction): 1/16 to 64 beats</p> <p>Effect level</p> <p>Depth of phaser effect: 1 to 9</p>
<b>HP FILTER</b>	Cyclically changes the cut-off frequency for the high-pass filter according to the beat.
<ul style="list-style-type: none"> <li>• ◀▶:</li> <li>• LEVEL/DEPTH:</li> <li>• Sub parameter:</li> </ul>	<p>Moving cycle of the effect with respect to 1 beat of the BPM (beat fraction): 1/16 to 64 beats</p> <p>Effect level</p> <p>Cycle to finely fluctuate the effect: 1 to 9</p>
<b>LP FILTER</b>	Cyclically changes the cut-off frequency for the low-pass filter according to the beat.
<ul style="list-style-type: none"> <li>• ◀▶:</li> <li>• LEVEL/DEPTH:</li> <li>• Sub parameter:</li> </ul>	<p>Moving cycle of the effect with respect to 1 beat of the BPM (beat fraction): 1/16 to 64 beats</p> <p>Effect level</p> <p>Cycle to finely fluctuate the effect: 1 to 9</p>

Beat FX/operation	Description
<b>TRANS</b>	Cyclically cuts the sound according to the beat.
<ul style="list-style-type: none"> <li>• : Cycle of the cut with respect to 1 beat of the BPM (beat fraction): 1/16 to 16 beats</li> <li>• <b>LEVEL/DEPTH</b>: Balance between the original sound and the effected sound, and duty</li> <li>• <b>Sub parameter</b>: Duty: 1 to 9</li> </ul>	
<b>ROLL</b>	Records the input sound when the effect is turned on, and outputs the recorded sound repeatedly according to the specified beat fraction.
<ul style="list-style-type: none"> <li>• : Effect time with respect to 1 beat of the BPM (beat fraction): 1/16 to 16 beats</li> <li>• <b>LEVEL/DEPTH</b>: Balance between the original sound and the effected sound, and mute amount</li> <li>• <b>Sub parameter</b>: Mute amount: 1 to 9</li> </ul>	
<b>FADER SYNTH (SINE/SAW/SQUARE)</b> <sup>2</sup>	Outputs a synth sound as the audio source of the base oscillation frequency.
<ul style="list-style-type: none"> <li>• : Base oscillation frequency level: -3 to +3</li> <li>• <b>LEVEL/DEPTH</b>: Effect volume</li> <li>• <b>Sub parameter</b>: Scale: 1 to 9 (AUTO SCALE, MAJOR, MINOR, MINOR H, JAPANESE, CHINESE, HAWAIIAN, RYUKYU, 2OCT ANALOG)</li> </ul>	

<sup>1</sup> You can't monitor the effected sound.

<sup>2</sup> You can't adjust the volume with the channel fader when the effect is turned on.

---

---

## Using FX Bank

You can save effect settings assigned to the **[FILTER]** knobs and the **[FX SELECT]** buttons to FX Banks, and load the FX Banks when you want to use them.

### ❖ Restrictions on operation

The following restrictions are applied when 2 computers (PC/Mac) are connected to the unit.

- You can't load an FX Bank.
- You can't change effects by turning the rotary selector while pressing the **[FX SELECT]** button.
- The Beat FX assigned to the buttons reset to the default settings (i.e. to the effects displayed on the **[FX SELECT]** buttons).

The restrictions aren't applied in the following cases.

- Input selector switches of **[CH 1]** and **[CH 2]** are set to **[A]**.
- Input selector switches of **[CH 1]** and **[CH 2]** are set to **[B]**.

---

---

## Setting an FX Bank

You can set up to 2 FX Banks using Setting Utility.

➤ Read more: Changing the assignment of the effects (page 26)

---

---

## Loading an FX Bank

You can load an FX Bank using the buttons on the unit.

### 1 Press the **[BRAKE]** or **[DUCK DOWN]** button while pressing the **[SHIFT]** button.

- **[BRAKE]**: Loads bank A.
- **[DUCK DOWN]**: Loads bank B.
- If banks are set in DJ software, the settings are also loaded.

## Using FX Trigger mode

You can use FX Trigger mode to apply Beat FX using Performance Pads even when a PC/Mac isn't connected to the unit or when using Instant Scratch.

Parameter values are preassigned to Performance Pads, so you can apply an effect only by pressing a Performance Pad.

- You can only use FX Trigger mode when one of the Beat FX is selected.

### 1 Set the input selector switch to [PHONO/LINE], or turn [INSTANT SCRATCH] on.

➡ Read more: Using Instant Scratch (page 67)

### 2 Press a Performance Pad.

The specified Beat FX is applied according to the number of beats assigned to the Performance Pad until you release the pad.

Example: When [ECHO] is selected

Performance Pad no.			
1	2	3	4
1/32 beat	1/16 beat	1/8 beat	1/4 beat
5	6	7	8
1/3 beat	1/2 beat	3/4 beat	1 beat

- Release the Performance Pad to turn the effect off.

---

---

# Smooth Echo

You can easily apply an echo to the sound being played using Smooth Echo.

---

---

## Smooth Echo section

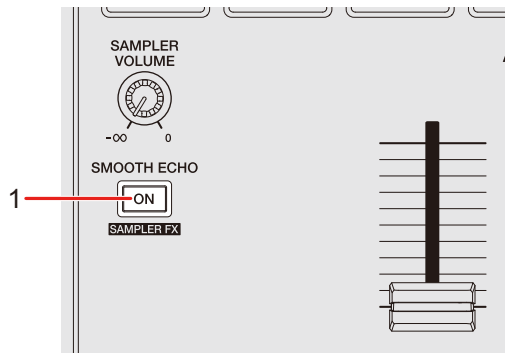

1. **SMOOTH ECHO ON button**  
Turns Smooth Echo on and off.

---

---

## Using Smooth Echo

- 1 **Press and hold the [BACK] button.**

The settings screen is displayed on the On Jog Display.

➤ Read more: Changing the settings (page 97)

- 2 **Select a trigger (operation) for the echo effect in [TRIGGER] of [SMOOTH ECHO].**

➤ Read more: Utility settings (page 98)

**3 Set the parameters in [BEATS] and [LEVEL] of [SMOOTH ECHO].**

**4 Press the [SMOOTH ECHO ON] button to turn Smooth Echo on.**

The button lights up when Smooth Echo is turned on.

**5 Perform the trigger operation to apply the echo.**

A delay sound is output several times while attenuating according to the number of beats.

- Press the [**BACK**] button to close the settings screen.  
If you press the [**BACK**] button while setting Smooth Echo, the display returns to the top level in the hierarchy, then closes the settings screen.
- You can't use Smooth Echo when Instant Scratch is in use. Smooth Echo turns off when Instant Scratch is turned on.



---

---

# Settings

---

---

## Changing the settings

### 1 Press and hold the [BACK] button.

The settings screen appears on the On Jog Display.

### 2 Turn the rotary selector to select a setting item.

### 3 Press the rotary selector to confirm the selection.

The screen for changing the setting appears.

### 4 Turn the rotary selector to select a setting value.

### 5 Press the rotary selector to confirm the selection.

The setting is confirmed and the display returns to the top level in the hierarchy.

- Press the [BACK] button to cancel the setting.

### 6 Press the [BACK] button.

The settings screen closes.

- If you press the [BACK] button while changing the setting, the display returns to the top level of the hierarchy, then closes the settings screen.

## Utility settings

\*: Factory setting

Setting item	Description
<b>SMOOTH ECHO</b>	
<b>CROSSFADER</b>	<p>Sets whether or not to apply an echo when the crossfader is moved to the opposite side and the sound is muted.</p> <ul style="list-style-type: none"> <li>Setting values: <b>ON*</b>, <b>OFF</b></li> </ul>
<b>CH FADER</b>	<p>Sets whether or not to apply an echo when the sound is muted by the channel fader.</p> <ul style="list-style-type: none"> <li>Setting values: <b>ON*</b>, <b>OFF</b></li> </ul>
<b>TRIGGER</b>	
<b>HOT CUE</b>	<p>Sets whether or not to apply an echo if a Hot Cue is triggered.</p> <ul style="list-style-type: none"> <li>Setting values: <b>ON</b>, <b>OFF*</b></li> </ul>
<b>SILENT CUE</b>	<p>Sets whether or not to apply an echo if a Silent Cue is triggered.</p> <ul style="list-style-type: none"> <li>Setting values: <b>ON*</b>, <b>OFF</b></li> </ul>
<b>LOAD</b>	<p>Sets whether or not to apply an echo if a track is loaded.</p> <ul style="list-style-type: none"> <li>Setting values: <b>ON*</b>, <b>OFF</b></li> </ul>
<b>BEATS</b>	
<b>BEATS</b>	<p>Sets the number of beats for an echo.</p> <ul style="list-style-type: none"> <li>Setting values: <b>1/8</b>, <b>1/4*</b>, <b>1/2</b>, <b>1</b>, <b>2</b>, <b>4</b>, <b>8</b></li> </ul>
<b>NUMBER OF BEATS TO TRIGGER (BY CROSSFADER)</b>	<p>Sets the number of beats for an echo.</p> <ul style="list-style-type: none"> <li>Setting values: <b>0*</b>, <b>1/2</b>, <b>1</b>, <b>2</b>, <b>4</b></li> </ul>
<b>LEVEL</b>	<p>Adjusts the echo volume.</p> <ul style="list-style-type: none"> <li>Setting values: <b>0</b> to <b>17</b>, <b>18*</b>, <b>19</b> to <b>36</b></li> </ul>
<b>MIC ECHO BEATS</b>	<p>Sets the number of beats for an echo.</p> <ul style="list-style-type: none"> <li>Setting values: <b>1/8</b>, <b>1/4</b>, <b>1/2</b>, <b>3/4</b>, <b>1*</b>, <b>2</b>, <b>4</b>, <b>8</b></li> </ul>

Setting item	Description
<b>AUTO STANDBY</b>	<p>Sets the auto standby function (page 101).</p> <ul style="list-style-type: none"> <li>Setting values: <b>OFF, ON*</b></li> </ul>
<b>DEMO/S.SAVER</b>	<p>Sets the time until demo mode starts and the screen saver if you don't use the unit for 30 minutes.</p> <ul style="list-style-type: none"> <li>Setting values: <b>DISABLE, DEMO 1min, DEMO 5min, DEMO 10min*, S.SAVER</b></li> <li>[<b>S.SAVER</b>]: Starts the screen saver if no operation is performed for 30 minutes.</li> </ul>
<b>MOTOR TORQUE</b>	<p>Sets the motor torque.</p> <ul style="list-style-type: none"> <li>Setting values: <b>LOW, HI*</b></li> </ul>
<b>TALKOVER MODE</b>	<p>Sets the talkover mode for the microphone (page 102).</p> <ul style="list-style-type: none"> <li>Setting values: <b>ADVANCED*, NORMAL</b></li> </ul>
<b>TALKOVER LEVEL</b>	<p>Sets the talkover level for the microphone.</p> <ul style="list-style-type: none"> <li>Setting values: <b>-6dB, -12dB, -18dB*, -24dB</b></li> </ul>
<b>MIC LOW CUT</b>	<p>Sets the low-frequency cut function for the microphone sound.</p> <ul style="list-style-type: none"> <li>Setting values: <b>OFF, ON*</b></li> </ul>
<b>PHONES OUT</b>	<p>Sets the output method (mono split or stereo) for the headphones monitor sound.</p> <ul style="list-style-type: none"> <li>Setting values: <b>STEREO*, MONO SPLIT</b></li> </ul>
<b>MIC TO BOOTH</b>	<p>Determines whether or not to output the microphone sound to the [<b>BOOTH</b>] terminals.</p> <ul style="list-style-type: none"> <li>Setting values: <b>OFF, ON*</b></li> </ul>
<b>MIC LMT (MSTR)</b>	<p>Sets whether or not to use the limiter for the microphone sound input to the master output sound.</p> <ul style="list-style-type: none"> <li>Setting values: <b>OFF, ON*</b></li> </ul>

Setting item	Description
<b>MIC LMT (BOOTH)</b>	<p>Sets whether or not to use the limiter for the microphone sound input to the sound output to the [BOOTH] terminals.</p> <ul style="list-style-type: none"> <li>Setting values: <b>OFF, ON*</b></li> </ul>
<b>MASTER OUT</b>	<p>Sets the output method (mono/stereo) for the sound output from the [MASTER 1] and [MASTER 2] terminals.</p> <ul style="list-style-type: none"> <li>Setting values: <b>STEREO*, MONO</b></li> </ul>
<b>MASTER ATT.</b>	<p>Sets the attenuation level of the sound output from the [MASTER 1] and [MASTER 2] terminals.</p> <ul style="list-style-type: none"> <li>Setting values: <b>0dB*, -6dB, -12dB</b></li> </ul>
<b>MASTER LIMITER</b>	<p>Reduces distortion to the sound output from the [MASTER 1] and [MASTER 2] terminals.</p> <ul style="list-style-type: none"> <li>Setting values: <b>OFF, ON*</b></li> </ul>
<b>BOOTH OUT</b>	<p>Sets the output method (mono/stereo) for the sound output from the [BOOTH] terminals.</p> <ul style="list-style-type: none"> <li>Setting values: <b>STEREO*, MONO</b></li> </ul>
<b>BOOTH ATT.</b>	<p>Sets the attenuation level of the sound output from the [BOOTH] terminals.</p> <ul style="list-style-type: none"> <li>Setting values: <b>0dB*, -6dB, -12dB</b></li> </ul>
<b>JOG DISP. BRT.</b>	<p>Sets the brightness of On Jog Display.</p> <ul style="list-style-type: none"> <li>Setting values: <b>1, 2, 3, 4, 5*</b></li> </ul>
<b>LED BRIGHTNESS</b>	<p>Sets the brightness of the buttons, Performance Pads, and OLED display.</p> <ul style="list-style-type: none"> <li>Setting values: <b>1, 2, 3*</b></li> </ul>
<b>SLIP FLASHING</b>	<p>Determines whether or not the indicators blink for buttons that can be used for Slip when you press the [SLIP] button.</p> <ul style="list-style-type: none"> <li>Setting values: <b>DISABLE, ENABLE*</b></li> </ul>

Setting item	Description
<b>SLIP LIT TYPE</b>	<p>Sets whether to light up or blink the <b>[SLIP]</b> button.</p> <ul style="list-style-type: none"> <li>Setting values: <b>LIT*</b>, <b>BLINK</b></li> <li><b>[LIT]</b>: Lights up the <b>[SLIP]</b> button when Slip is turned on, and blinks it during slip playback.</li> <li><b>[BLINK]</b>: Blinks the <b>[SLIP]</b> button when Slip is turned on.</li> </ul>
<b>MIDI MODE</b>	<p>Sets the unit's MIDI mode.</p> <ul style="list-style-type: none"> <li>Setting values: <b>AUTO*</b>, <b>GENERAL</b></li> <li><b>[AUTO]</b>: Works in the most suitable controller mode for Serato DJ Pro when the software is running, and works as a general MIDI controller when Serato DJ Pro isn't running.</li> <li><b>[GENERAL]</b>: Works as a general MIDI controller whether Serato DJ Pro is running or not.</li> <li>To select <b>[GENERAL]</b>, close Serato DJ Pro.</li> </ul>
<b>FACTORY RESET</b>	<p>Restores the factory settings.</p> <ul style="list-style-type: none"> <li>Setting values: <b>cancel*</b>, <b>reset</b></li> </ul>

## Auto standby

When **[AUTO STANDBY]** is set to **[ON]**, the unit enters standby mode after 4 hours without being used (no audio signal (more than -24 dB) is input to the unit).

Press the **[SLIP]** button on the left deck to exit standby mode.

- The factory setting is **[ON]**.
- Set **[AUTO STANDBY]** to **[OFF]** if you don't need to use the auto standby function.

---

## Talkover mode

- **[ADVANCED]:**

Attenuates the middle range of all sound other than the Mic channel according to the talkover level setting.

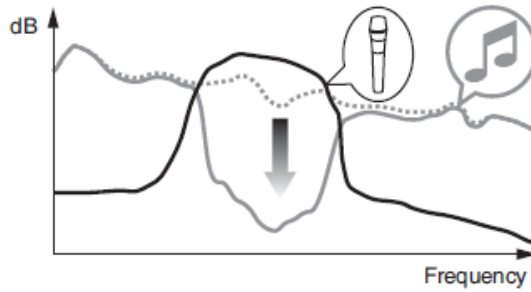

- **[NORMAL]:**

Attenuates all sound other than the Mic channel according to the talkover level setting.

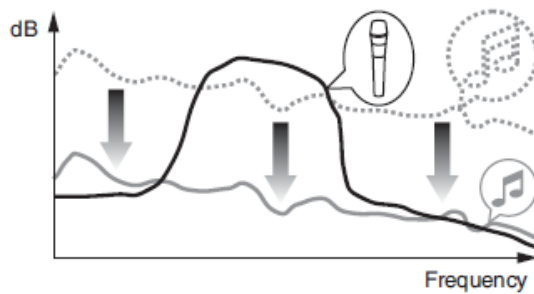

---

## Replacing the slip sheets

---

---

### Adjusting the weight for scratching

You can change the weight for scratching by replacing the slip sheets under the top plate.

- Turn the unit off before replacing the slip sheets.

#### 1 Remove the top plate.

- Carefully hook a pointed object under the outer edge of the top plate and lift it.

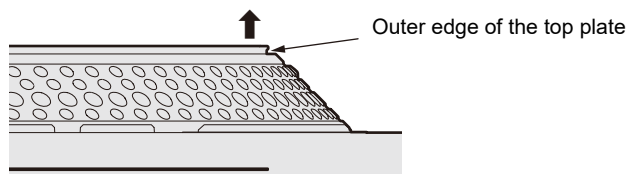

#### 2 Replace the slip sheets.

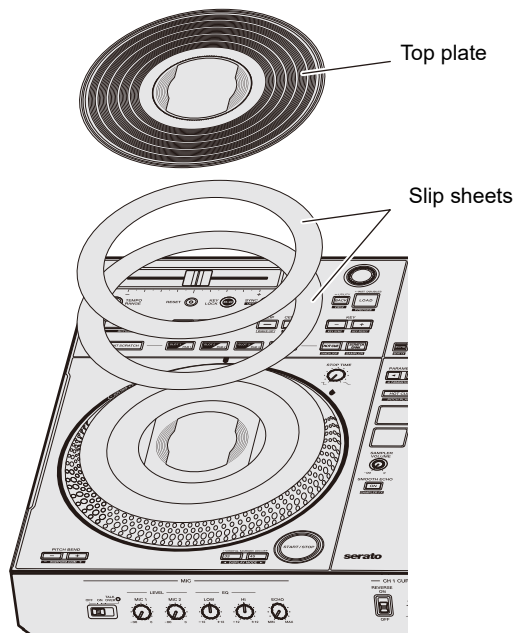

- Replace the preinstalled slip sheets (PET two-stacked slip sheets) with slip sheets you like.
  - Suitable slip sheet size: Outer diameter  $\phi 174$  mm, inner diameter 135 mm, total thickness less than 1.6 mm
  - Recommended number of slip sheets: 2 sheets
- The slip sheet is an important part for the rotation of the top plate, so be sure to handle it with care.

### 3 Align the notch on the top plate with the protrusion, and attach the top plate.

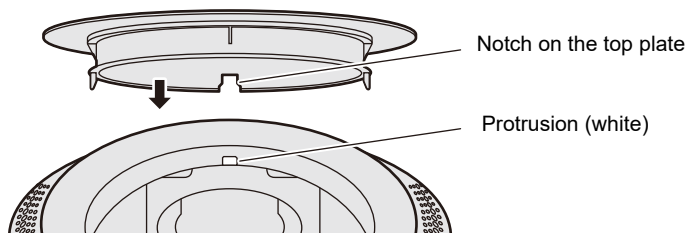

- To prevent foreign objects and dust from entering the jog wheel, attach the top plate immediately after replacing the slip sheets.



---

---

# Using other types of DJ software (via MIDI)

If you connect a PC/Mac with MIDI software installed, to the unit via a USB cable, you can control the DJ software via the unit.

- To play tracks stored on a PC (Windows) with the unit, install the dedicated audio driver software (page 21).
- For details on the unit's MIDI messages, visit the URL below.

[pioneerdj.com/support/](http://pioneerdj.com/support/)

- Install DJ software and configure the audio and MIDI settings on a PC/Mac beforehand.
- You can set MIDI mode of this unit in **[MIDI MODE]** in the Utility settings (page 101).
- You can't use some buttons on the unit for controlling DJ software depending on the DJ software you use.

---

---

# Specifications

## AC adapter

Power requirements .....	AC 100 V – 240 V, 50 Hz / 60 Hz
Rated current .....	1.5 A
Rated output .....	DC 24 V, 3.75 A

## General – Main unit

Power consumption .....	DC 24 V, 1 000 mA
Main unit weight .....	10.7 kg / 23.6 lbs.
Max. external dimensions .....	(W x H x D) 732 x 82.4 x 382.2 mm / 28.8" x 3.2" x 15.0"
Tolerable operating temperature .....	+5 °C – +35 °C (+41 °F – +95 °F)
Tolerable operating humidity .....	5 % – 85 % (no condensation)

## Turntable part

Drive method .....	Servo type direct drive
Motor .....	3-phase brushless DC motor
Braking system .....	Electronic brake
Rotation speed .....	33 1/3 rpm, 45 rpm
Rotation speed adjustment range .....	±8 %, ±16 %, ±50 %
Turntable .....	Aluminum die-casting Diameter: 207 mm
Starting torque .....	0.18 N·m (1.8 kgf·cm)
Start time .....	0.7 seconds (at 33 1/3 rpm)

## Audio section

Sampling rate .....	48 kHz
A / D, D / A converter .....	24bit
Frequency characteristic	
USB, LINE, AUX (LINE / PORTABLE), MIC 1, MIC 2 .....	20 Hz – 20 kHz
S / N ratio (rated output, A-WEIGHTED)	
USB .....	110 dB
LINE .....	95 dB
PHONO .....	84 dB
AUX (LINE) .....	95 dB
AUX (PORTABLE) .....	89 dB
MIC 1 .....	81 dB
MIC 2 .....	81 dB

# Specifications

## Total harmonic distortion (20 Hz – 20 kHzBW)

USB .....	0.003 %
LINE .....	0.005 %
PHONO .....	0.017 %

## Standard input level / Input impedance

LINE .....	-12 dBu / 47 k $\Omega$
PHONO .....	-52 dBu / 47 k $\Omega$
AUX (LINE) .....	-12 dBu / 47 k $\Omega$
AUX (PORTABLE).....	-24 dBu / 47 k $\Omega$
MIC 1.....	-57 dBu / 3 k $\Omega$
MIC 2.....	-57 dBu / 3 k $\Omega$

## Standard output level / Load impedance / Output impedance

MASTER 1 .....	+6 dBu / 10 k $\Omega$ / 450 $\Omega$ or less
MASTER 2 .....	+2 dBu / 10 k $\Omega$ / 820 $\Omega$ or less
BOOTH .....	+6 dBu / 10 k $\Omega$ / 820 $\Omega$ or less
PHONES .....	+8 dBu / 32 $\Omega$ / 10 $\Omega$ or less

## Rated output level / Load impedance

MASTER 1 .....	+24 dBu / 10 k $\Omega$
MASTER 2 .....	+20 dBu / 10 k $\Omega$
BOOTH .....	+24 dBu / 10 k $\Omega$

## Crosstalk

LINE .....	89 dB
PHONO .....	78 dB

## Channel equalizer characteristic

HI.....	$-\infty$ dB – +6 dB (20 kHz)
MID.....	$-\infty$ dB – +6 dB (1 kHz)
LOW.....	$-\infty$ dB – +6 dB (20 Hz)

## Microphone equalizer characteristic

HI.....	-12 dB – +12 dB (10 kHz)
LOW.....	-12 dB – +12 dB (100 Hz)

## Input / Output terminals

### LINE / PHONO input terminals

RCA pin jacks .....	2 sets
---------------------	--------

### MIC input terminal

XLR connector & 1/4" TRS jack .....	1 set
1/4" TRS jack .....	1 set

### AUX input terminal

RCA pin jacks .....	1 set
---------------------	-------

MASTER 1 output terminal	
XLR connector .....	1 set
MASTER 2 output terminal	
RCA pin jacks .....	1 set
BOOTH output terminal	
1/4" TRS jack .....	1 set
PHONES output terminal	
1/4" stereo jack .....	1 set
3.5 mm stereo mini jack .....	1 set
USB terminals	
USB type-B .....	2 sets

## Specifications of external power supply (for European Union customers)

Manufacturer's name .....	ALPHATHETA EMEA LIMITED
Commercial registration number .....	09230173
Address ....	Artemis, Odyssey Business Park, West End Road, South Ruislip, England, HA4 6QE
Model identifier .....	UNI390-2437
Input voltage .....	AC 100 V to 240 V
Input AC frequency .....	50 Hz / 60 Hz
Output voltage .....	DC 24.0 V
Output current .....	3.75 A
Output power .....	90.0 W
Average active efficiency .....	88.3 %
Efficiency at low load (10 %) .....	88.5 %
No-load power consumption .....	0.19 W

## Information requirements of the European Ecodesign Directive

English

- Use the [**MASTER 1**] terminals for balanced output only. Connecting the terminals to unbalanced inputs (RCA, etc.) with an XLR-RCA conversion cable (conversion adapter), etc. results in unwanted noises and/or poor sound quality.
- Use the [**MASTER 2**] terminals for unbalanced input (RCA, etc.).
- Use the [**BOOTH**] terminals for balanced output only. Connecting the terminals to unbalanced inputs (RCA, TS connector, etc.) with a TRS-RCA conversion cable (conversion adapter) or TS cable, etc. results in unwanted noises and/or poor sound quality.

The specifications and design of this product are subject to change without notice.

## Block diagram

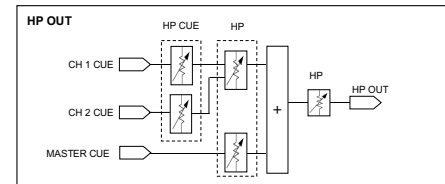
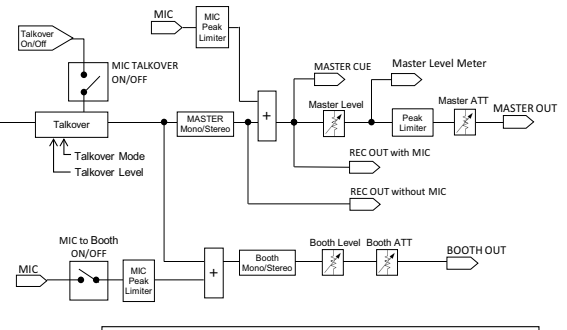
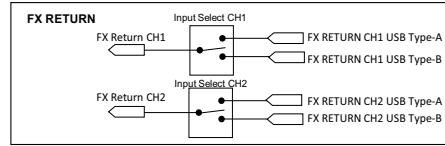
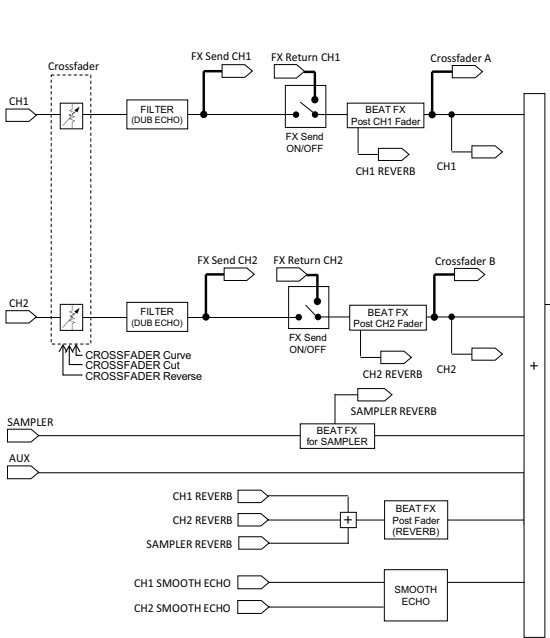
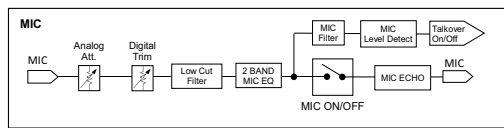
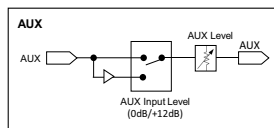
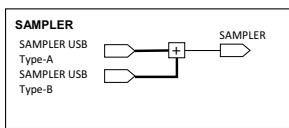
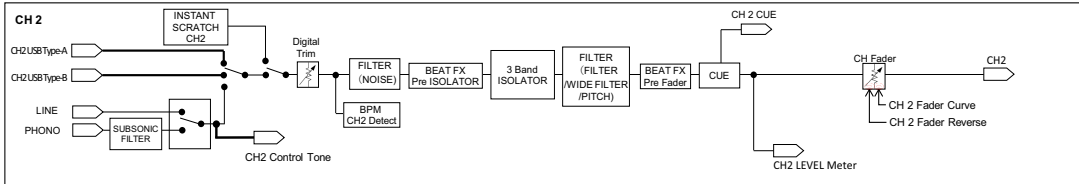
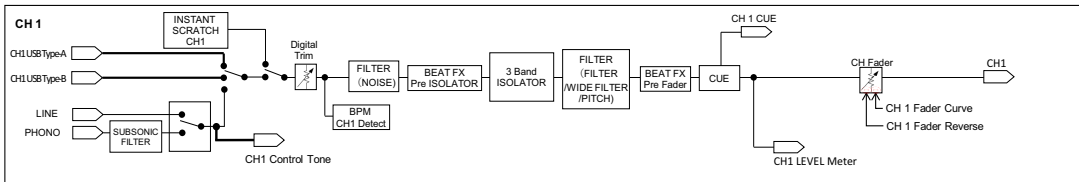

# Specifications

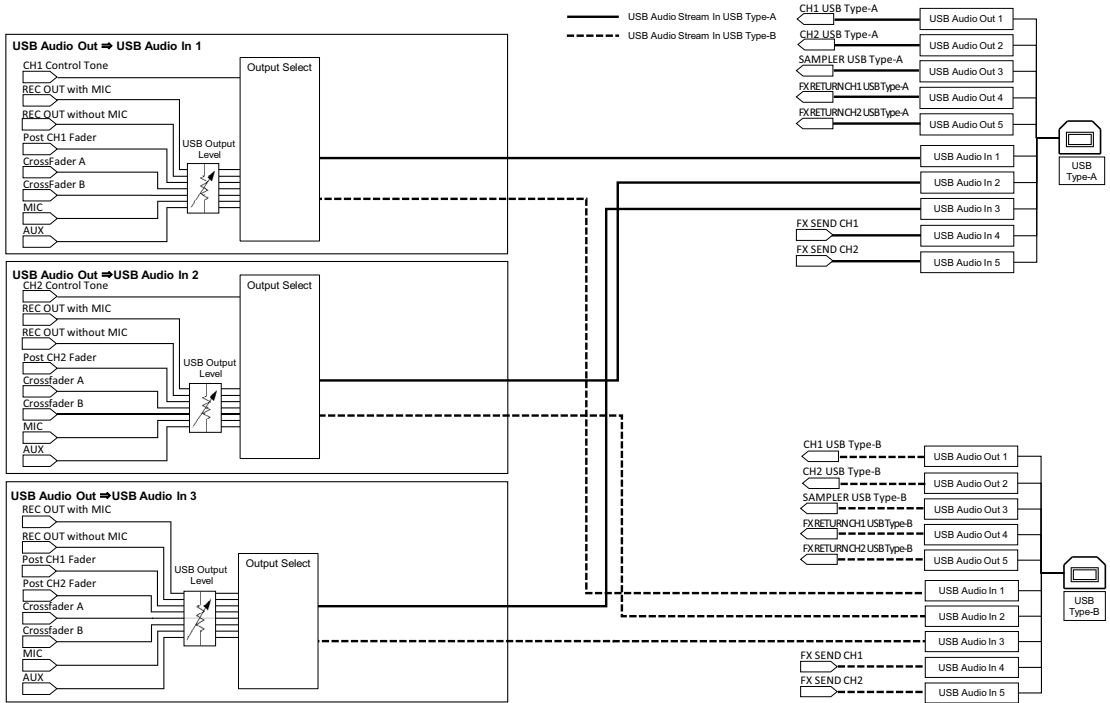

---

---

# Additional information

---

---

## Troubleshooting

If you think something is wrong with the unit, check the information below and refer to the [FAQ] for the DDJ-REV7 at the URL below.

[pioneerdj.com/support/](http://pioneerdj.com/support/)

- Inspect devices connected with the unit.
- The unit may restore proper operation after you turn it off and on.

If the problems continue, read the “Precautions for Use” and consult an authorized service company or your dealer.

---

---

## Power

### ❖ The unit doesn't turn on.

- See Connections (basic styles) (page 31).
- Press the ⏻ button on the rear of the unit to turn it on.

---

---

## Connection

### ❖ The unit isn't recognized.

- Connect the supplied USB cable properly (page 13).
- You can't use a USB hub. Connect the USB device directly to the unit.
- If a USB device other than this unit is connected to your PC/Mac, disconnect it.
- If you use a PC (Windows), install the dedicated audio driver software properly (page 21).
- Close all applications (including any screen saver and resident software) running on your PC/Mac before using the unit. When you close anti-virus software, etc., disconnect from the internet to ensure the safety of your PC/Mac.
- If you use a PC (Windows), uninstall unnecessary ASIO drivers other than the one for this unit.
- Check if the unit is recognized by your PC/Mac, and the firmware version of the unit is displayed in Setting Utility (page 29).

## Audio output

### ❖ The unit doesn't output sound / the volume is low / the sound is distorted.

- Set the [TRIM] knob, [MASTER LEVEL] knob, [LINE/PHONO] selector switch, and input selector switch properly.
- Check all cables are connected properly (page 13).
- Wipe any dust or dirt off the terminals and plugs before connecting them.
- If you use a Mac, set the buffer size (latency) properly for the DJ software you're using.
- If you use a PC (Windows), set the buffer size properly in Setting Utility (page 25).

### ❖ Microphone sound isn't output.

- Set the [OFF, ON, TALKOVER] selector switch properly (page 77).

### ❖ Sampler sound can't be monitored with headphones.

- Set the [SAMPLER VOLUME] knob properly.
- Set [Sampler Player Output Select] to [A] in Serato DJ Pro.

---

## Serato DJ Pro

### ❖ Serato DJ Pro is unstable.

- Update Serato DJ Pro to the latest version.
- Close all software other than Serato DJ Pro. If Serato DJ Pro is still unstable, disable the wireless connection, anti-virus software, screen-saver, and power saving mode. When you close anti-virus software, etc., disconnect from the internet to ensure the safety of your PC/Mac.
- If a USB device other than this unit is connected to your PC/Mac, disconnect it.
- You can't use a USB hub. Connect the USB device directly to the unit.
- If you're using your laptop with battery power, connect it to the AC power.

### ❖ Tracks are not displayed in the library.

- If tracks are not displayed in the library, import audio files. For details on how to import audio files, refer to the Serato DJ Pro software manual (page 7).
- Check if you've selected a crate or subcrate that doesn't include tracks. If so, select a crate or subcrate that includes tracks, or add tracks to the crate or subcrate.



### ❖ Tracks from iTunes aren't displayed in the library.

- If no check mark is placed in the check box for **[Show iTunes Library]** on the **[Library + Display]** tab of the **[SETUP]** menu, mark the check box. If a check mark has been placed in the check box, remove it and mark the check box again. For details on how to import audio files, refer to the Serato DJ Pro software manual (page 7).
- Check if you've selected a crate or subcrate that doesn't include tracks. If so, select a crate or subcrate that includes tracks, or add tracks to the crate or subcrate.

### ❖ Audio files in the library can't be edited.

- If **[Protect Library]** is enabled on the **[Library + Display]** tab of the **[SETUP]** menu, disable it.

### ❖ The virtual deck of Serato DJ Pro isn't displayed (offline player is displayed).

- Connect the supplied USB cable correctly (page 31).
- Update Serato DJ Pro to the latest version.

---

## Others

### ❖ BPM isn't displayed / Sync/Auto Loop doesn't work.

- Mark the check box for **[Set Auto BPM]** in the offline player setting, then analyze tracks. For details on how to analyze tracks, refer to the Serato DJ Pro software manual (page 7).

### ❖ BPM and beatgrid aren't displayed correctly / Beatgrid isn't accurate.

- Change the BPM analysis range, then analyze the track again. If it still doesn't resolve the problem, manually set the beatgrid and/or BPM.
- Adjust the beatgrid. For details on how to adjust the beatgrid, refer to the Serato DJ Pro software manual (page 7).

### ❖ The jog wheel doesn't rotate.

- Set the input selector switch to **[A]** or **[B]**, then press the **[START/STOP]** button.

### ❖ Playback sound is interrupted when using DJ software.

- If you use a Mac, set the buffer size (latency) properly for the DJ software you're using.
- If you use a PC (Windows), set the buffer size properly in Setting Utility (page 25).

### ❖ **BPM is displayed but the beatgrid isn't displayed / Slicer Loop doesn't work / Jog Skip doesn't work.**

- Mark the check boxes for **[Set Auto BPM]** and **[Set Beatgrid]** in the offline player setting, then analyze the track. For details on how to analyze tracks, refer to the Serato DJ Pro software manual (page 7).
- Set the beatgrid. For details on how to set the beatgrid, refer to the Serato DJ Pro software manual (page 7).

### ❖ **On Jog Display operation indicator doesn't rotate during playback.**

**Operation indicator rotates during playback but it doesn't sync with the virtual deck of Serato DJ Pro.**

**The [TEMPO] slider doesn't work if the deck is switched.**

- Set **[MIDI MODE]** to **[AUTO]** in the Utility settings (page 101).

### ❖ **Indicators blink and something is wrong with the unit.**

- If something is wrong with the unit or the unit doesn't turn on, pull out the AC adapter cable from the DC jack, then connect it after a while. If this doesn't resolve the problem, request a repair.

---

---

## LCD display

- Small black or shining points may appear on the LCD display. This is a phenomenon inherent to LCD displays and not a malfunction.
- When using the unit in cold places, the LCD display may be dark for a while after the power is turned on. Normal brightness will restore after a while.
- When the LCD display is exposed to direct sunlight, the light will reflect off it, making it difficult to see. Block the direct sunlight to improve visibility of the display.

---

---

## Cleaning

Wipe with a dry soft cloth.

- Do not use organic solvents, acids or alkalis for cleaning.

---

---

## Trademarks and registered trademarks

- Mac, macOS and Finder are trademarks of Apple Inc., registered in the U.S. and other countries.
- Windows is a registered trademark of Microsoft Corporation in the U.S. and other countries.
- ASIO is a trademark or registered trademark of Steinberg Media Technologies GmbH.
- Serato DJ Pro is a registered trademark of Serato Limited.

Other product, technology and company names, etc. mentioned herein are trademarks or registered trademarks of their respective owners.

---

## Software license notice

- This software is based in part on the work of the Independent JPEG Group.

### Apache

Copyright (c) 2009-2019 ARM Limited. All rights reserved.

SPDX-License-Identifier: Apache-2.0

Licensed under the Apache License, Version 2.0 (the License); you may not use this file except in compliance with the License.

You may obtain a copy of the License at

[www.apache.org/licenses/LICENSE-2.0](http://www.apache.org/licenses/LICENSE-2.0)

Unless required by applicable law or agreed to in writing, software distributed under the License is distributed on an AS IS BASIS, WITHOUT WARRANTIES OR CONDITIONS OF ANY KIND, either express or implied.

See the License for the specific language governing permissions and limitations under the License.

### BSD

The BSD-3-Clause License

Copyright (c) 2015, Freescale Semiconductor, Inc.

Copyright 2016-2020 NXP

All rights reserved.

Redistribution and use in source and binary forms, with or without modification, are permitted provided that the following conditions are met:

1. Redistributions of source code must retain the above copyright notice, this list of conditions and the following disclaimer.
2. Redistributions in binary form must reproduce the above copyright notice, this list of conditions and the following disclaimer in the documentation and/or other materials provided with the distribution.
3. Neither the name of the copyright holder nor the names of its contributors may be used to endorse or promote products derived from this software without specific prior written permission.

## Additional information

THIS SOFTWARE IS PROVIDED BY THE COPYRIGHT HOLDERS AND CONTRIBUTORS "AS IS" AND ANY EXPRESS OR IMPLIED WARRANTIES, INCLUDING, BUT NOT LIMITED TO, THE IMPLIED WARRANTIES OF MERCHANTABILITY AND FITNESS FOR A PARTICULAR PURPOSE ARE DISCLAIMED. IN NO EVENT SHALL THE COPYRIGHT HOLDER OR CONTRIBUTORS BE LIABLE FOR ANY DIRECT, INDIRECT, INCIDENTAL, SPECIAL, EXEMPLARY, OR CONSEQUENTIAL DAMAGES (INCLUDING, BUT NOT LIMITED TO, PROCUREMENT OF SUBSTITUTE GOODS OR SERVICES; LOSS OF USE, DATA, OR PROFITS; OR BUSINESS INTERRUPTION) HOWEVER CAUSED AND ON ANY THEORY OF LIABILITY, WHETHER IN CONTRACT, STRICT LIABILITY, OR TORT (INCLUDING NEGLIGENCE OR OTHERWISE) ARISING IN ANY WAY OUT OF THE USE OF THIS SOFTWARE, EVEN IF ADVISED OF THE POSSIBILITY OF SUCH DAMAGE.

### **Cautions on copyrights**

Recordings you have made are for your personal enjoyment and according to copyright laws may not be used without the consent of the copyright holder.

- Music recorded from CDs, etc., is protected by the copyright laws of individual countries and by international treaties. It is the full responsibility of the person who has recorded the music to ensure that it is used legally.
- When handling music downloaded from the Internet, etc., it is the full responsibility of the person who has downloaded the music to ensure that it is used in accordance with the contract concluded with the download site.

The specifications and design of this product are subject to change without notice.

© 2021 AlphaTheta Corporation. All rights reserved.

<DRI1713-A>